

E
174
54
198
4.2
ZDOC

crime



REPORT OF THE
DEPARTMENT OF
PUBLIC SAFETY

in arizona

1996

NOV 1996

CRIME IN ARIZONA 1996

*An annual report compiled by
the Arizona Department of Public Safety*

**Joe Albo
Director
Arizona Department of Public Safety**



ARIZONA DEPARTMENT OF PUBLIC SAFETY

2102 WEST ENCANTO BLVD. P. O. BOX 6638 PHOENIX, ARIZONA 85005-6638 (602) 223-2000



JANE LEE HULL
GOVERNOR

JOE ALBO
DIRECTOR

FOREWORD

The Arizona Department of Public Safety is pleased to participate in and serve as the coordinating agency for the Arizona Crime Reporting Program.

The purpose of the 1996 "Crime in Arizona" report is to provide data regarding the nature and extent of crime throughout the State. This report does not draw conclusions as to the causes of crime. The report does provide the vital information necessary to assist law enforcement agencies, government, and the public in their approach to crime in our state.

This report is the culmination of a joint effort by our state's law enforcement agencies to collect and organize crime data. The information contained in this report should provide a valuable overview of the crime problem.

This is the fifth year that data concerning the nature and extent of bias (hate) crimes has been included. Again, this information does not draw conclusions as to the causes of crimes committed due to bias, but it is an additional resource that can be utilized by the citizens of Arizona.

Sincere appreciation is expressed to all Arizona law enforcement agencies without whose cooperation this publication would not be possible.

Joe Albo
Director

DEDICATION

**This publication is dedicated to those Arizona Law Enforcement Officers
who gave their lives in the line of duty during 1996.**

Officer Hoskie Gene
Navajo Department of Law Enforcement
January 6, 1996

**We also wish to acknowledge the sacrifice
of an Arizona K-9 during 1996.**

K-9 Hunter
Phoenix Police Department
April 17, 1996

TABLE OF CONTENTS

THE ARIZONA UNIFORM CRIME REPORTING SYSTEM	9-14
SUMMARY OF STATE CRIME DATA	15
Arizona Crime Clock	16
Arizona Crime Cycle	17
State Crime Summary	18-19
State Crime Index	20
Index Crime Comparison	21
Value of Property Loss by Index Crime Offense	22
Type and Value of Property Stolen and Recovered	22
PART I INDEX CRIMES	23-24
Murder	25
Definition and Summary	25
Murder by Month	26
Murder by Day of Week	26
Murder by Time of Day	27
Murder Distribution by Circumstance	27
Murder by Type of Weapon Used	28
Murder Distribution by Relationship	28
Murder Victim by Age, Sex, Race, and Ethnic Origin	29
Forcible Rape	30
Definition and Summary	30
Rape by Month	31
Robbery	32
Definition and Summary	32
Robbery by Location and Value	33
Robbery by Month and Weapon Used	33
Aggravated Assault	34
Definition and Summary	34
Assault by Weapon Used	35
Assault by Month	35
Burglary	36
Definition and Summary	36
Burglary by Location and Time	37
Burglary by Month and Means of Entry	37
Larceny-Theft	38
Definition and Summary	38
Larceny-Theft by Type by Month	39
Larceny-Theft by Value by Month	39
Larceny-Theft by Classification and Value	40
Additional Analysis	40
Motor Vehicle Theft	41
Definition and Summary	41
Motor Vehicle Theft by Month	42
Stolen Vehicle by Type	42

TABLE OF CONTENTS

Arson		43
	Definition and Summary	43
	Arson by Property Classification	44
	Value of Property Damaged	44
	Arson Offenses by Property Type by Month	45
COUNTY OFFENSE AND SUPPLEMENTAL DATA		47
	Index Crimes	48-49
	Analysis of Robbery, Burglary, and Larceny-Theft	50-51
	Value, in Dollar, of Property Stolen by Crime	52-53
	Type and Value, in Dollars, of Property Stolen and Recovered	54-55
STATE ARREST DATA		57
	Summary	58
	Arrests by Age Group	58
	Total Arrests by Offense, Race and Ethnic Origin	59
	Juvenile Arrests by Offense, Race and Ethnic Origin	60
	Adult Arrests by Offense, Race and Ethnic Origin	61
	Total Arrests by Age	62-63
	Juvenile Male Arrests	64
	Juvenile Female Arrests	65
	Adult Male Arrests	66-67
	Adult Female Arrests	68-69
COUNTY ARREST DATA		71
	Apache County	72-73
	Cochise County	74-75
	Coconino County	76-77
	Gila County	78-79
	Graham County	80-81
	Greenlee County	82-83
	La Paz County	84-85
	Maricopa County	86-87
	Mohave County	88-89
	Navajo County	90-91
	Pima County	92-93
	Pinal County	94-95
	Santa Cruz County	96-97
	Yavapai County	98-99
	Yuma County	100-101
	Police Disposition of Juveniles	102
AGENCY DATA		103-113
ASSAULTS ON LAW ENFORCEMENT OFFICERS		115
	Definition and Summary	116
	Injury vs. Noninjury	116
	Weapons Used	117
	Time of Day	117
	Officers Assaulted Frequency Distribution	118
	Officers Assaulted Distribution by County	119

TABLE OF CONTENTS

BIAS CRIMES DATA	121
Background	122
Five Year Comparison	122
Definition and Summary	123
Offenses by Quarter for 1995	123
Offenses by Location	124
Offenses by Motivation	125
Offenses by County	126
Offenses by Agency	127-130
 GLOSSARY	 131-132

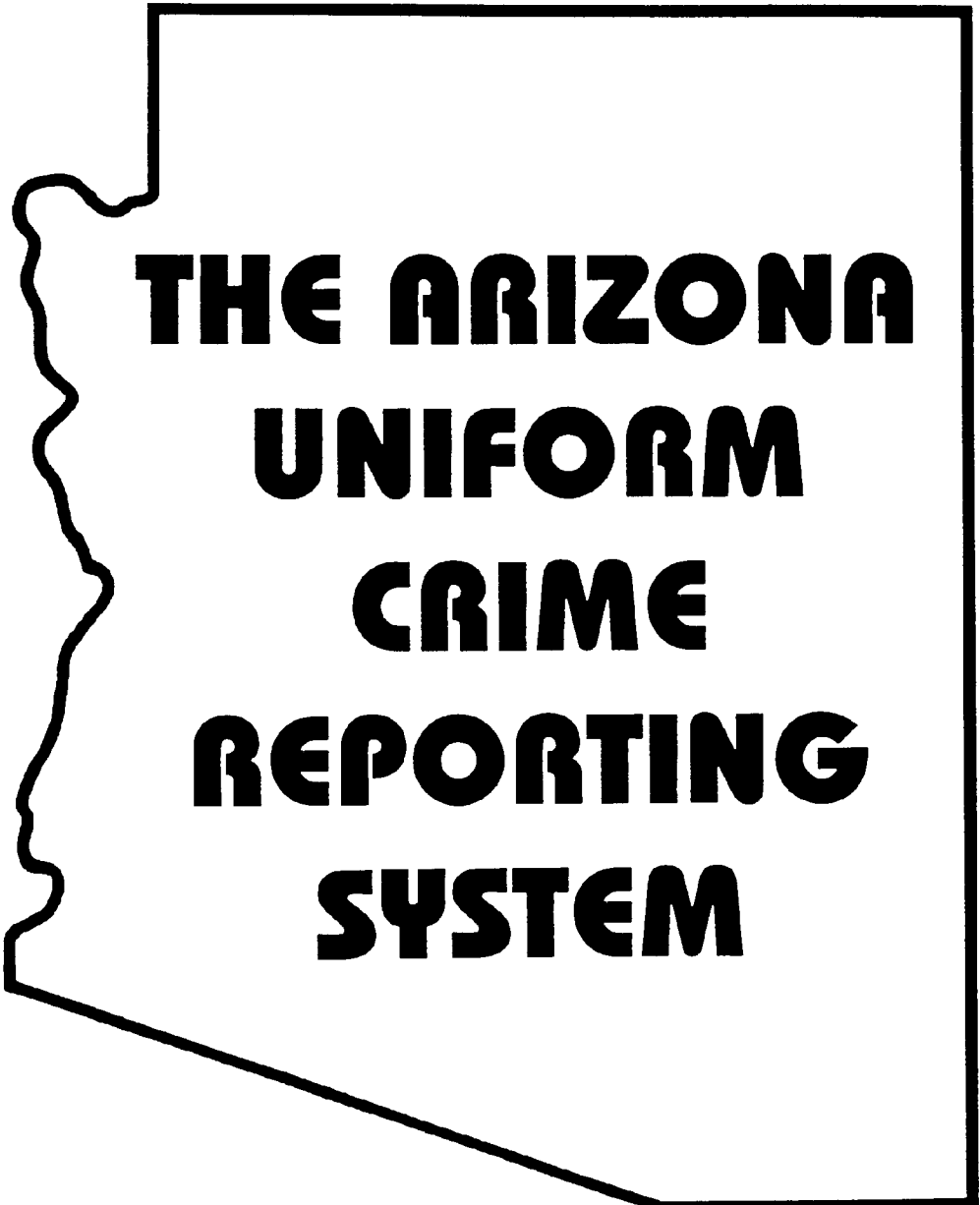

**THE ARIZONA
UNIFORM
CRIME
REPORTING
SYSTEM**

Historical Background

The Uniform Crime Reporting (UCR) program provides a nationwide view of crime based on the voluntary submission of statistics by city, county, and state law enforcement agencies. This program was initiated in 1930 by the Committee on Uniform Crime Records of the International Association of Chiefs of Police (IACP). That same year, the Federal Bureau of Investigation (FBI) was authorized by the United States Congress to serve as the national clearinghouse for statistical information on crime. The IACP continues to serve the Uniform Crime Reporting program in an advisory capacity and was joined in this responsibility by the Committee on Crime Records of the National Sheriff's Association (NSA) in 1966.

A variety of statistics could have been used to portray the crime problem in the United States, including penal, prosecutive, arrest, offense, and conviction data. But to best depict crime and provide meaningful data to the police agencies, it was determined that data dealing with known offenses and persons arrested would be collected. Initially, because of their seriousness and frequency of occurrence, seven offenses were chosen to serve as an Index for gauging fluctuations in the overall volume and rate of crime. These offenses include the violent crimes of murder and non-negligent manslaughter, forcible rape, robbery, aggravated assault and the property crimes of burglary, larceny-theft, and motor vehicle theft. By congressional mandate, arson was added as the eighth Index offense in 1979.

Further, because of the variances in punishment for the same offenses in different state codes, no distinction between felony and misdemeanor crimes was possible. To avoid these problems and provide nationwide uniformity in crime reporting, standardized offense definitions by which law enforcement agencies were to submit data, without regard to local statutes, were formulated.

Arizona Program

The Arizona Uniform Crime Reporting program first began receiving voluntary crime statistics from local law enforcement agencies in January 1975. Prior to this date, agencies submitted their crime data directly to the Federal Bureau of Investigation. The Arizona Department of Public Safety is responsible for administering the UCR program for the state and providing necessary assistance and training to the contributing law enforcement agencies.

After the 1992 Arizona legislative session, participation in the UCR program became mandatory. Arizona Revised Statute 41-1750.A.2 directs that the Central State Repository of the Department of Public Safety shall:

"Collect information concerning the number and nature of offenses known to have been committed in this state and of the legal steps taken in connection with these offenses, such other information that is useful in the study of crime and in the administration of criminal justice and all other information deemed necessary to operate the statewide uniform crime reporting program and to cooperate with the federal government uniform crime reporting program."

Also, Arizona Revised Statute 41-1750.D directs that:

"The chief executive officers of law enforcement agencies of this state or its subdivisions shall provide to the central state repository such information as necessary to operate the statewide uniform crime reporting program and to cooperate with the federal government uniform crime reporting program."

Statistics are received from local police agencies, county sheriff's offices, college and university campus police, and state police agencies. Federal agencies and tribal police agencies do not report to the Arizona UCR program and are therefore not included in this publication.

The goal of this publication is to identify the nature and extent of criminal activity in this state. This information will not in itself prevent crime, but it may encourage all segments of society, by understanding the problem, to work together with law enforcement agencies to reduce crime through more effective enforcement.

Crime Factors

Statistics are used to summarize information so that patterns or trends become clearer. Too often information of the type in this publication is used incorrectly to draw conclusions that the statistics simply do not support. Some of the factors which are known to affect the volume and type of crime occurring from place to place are:

Population density and degree of urbanization.

Variations in composition of the population, particularly youth concentration.

Stability of population with respect to residents' mobility, commuting patterns, and transient factors.

Modes of transportation and highway systems.

Economic conditions, including median income, poverty level, and job availability.

Cultural factors and educational, recreational, and religious characteristics.

Family conditions with respect to divorce and family cohesiveness.

Climate.

Effective strength of law enforcement agencies.

Administrative and investigative emphases of law enforcement.

Policies of other components of the criminal justice system (i.e., prosecutorial, judicial, correctional, and probational).

Citizens' attitudes toward crime.

Crime reporting practices of the citizenry.

The Arizona Uniform Crime Reporting program gives a statewide view of crime based on statistics furnished by state and local law enforcement agencies. Population size is the only correlate of crime utilized in this publication. While the other factors listed above are of equal concern, no attempt is made to relate them to the data listed. The reader is, therefore, cautioned against comparing statistical data of individual reporting units from cities, counties, metropolitan areas, states, or colleges and universities solely on the basis of their population coverage or student enrollment. (Crime in the United States, 1995, p. iv.)

Scoring of Offenses

Only the number of those offenses for Part I crimes and simple assault are scored (counted) under the Uniform Crime Reporting program. The method of scoring offenses varies with the type of crime committed, and it is important to remember that the number of offenders does not determine the number of offenses.

For murder and non-negligent manslaughter, negligent manslaughter, forcible rape, aggravated assault and simple assault, one offense is scored for each victim, regardless of the number of offenders involved. For example, two offenders could be involved in the murder of one victim and in this case only one murder would be scored.

For robbery and larceny-theft, one offense is scored for each distinct operation which is separate in time and place. The number of victims in any one operation does not determine the number of offenses. For example, if seven patrons in a bar are robbed, only one robbery would be counted. However, if the offender then leaves the bar and robs a passer-by, a second offense would be counted.

For burglary, one offense is scored for each structure which is illegally entered. For UCR purposes, a structure is generally defined as an enclosed, permanently occupied area. However, when the structure is an apartment complex, business or office building in which units are leased for a period of time, one offense is counted for each unit burglarized. The illegal entry of those structures used for the housing of a transient population such as hotel rooms or boarding houses are scored as one burglary regardless of the number of rooms entered.

For motor vehicle theft, one offense is scored for each vehicle stolen. For UCR purposes, a motor vehicle is defined as a self-propelled vehicle that runs on land and not rails. For arson, one offense is scored for each occurrence even if a more serious offense occurred as the result of the arson. Additionally, any attempts to commit any of the above offenses are also counted under the appropriate offense category with the exception of attempted murder which is listed under aggravated assault.

For multiple offenses that occur in one crime incident, only the most serious offense is counted. The exceptions are arson (which is always counted) and a combination of larceny-theft and motor vehicle theft (the motor vehicle theft will be counted). Part I offenses are ranked according to seriousness and appear in order from most serious to least serious under Offense Definitions. A Part II offense that occurs in conjunction with Part I offenses or by itself is not counted.

Clearances

An offense is considered cleared (solved) when at least one offender is arrested for a crime, even though several may have been involved. Offenses may also be cleared by exceptional means when the offender: Commits suicide; makes a dying declaration; confesses while in custody or serving time for another crime; is prosecuted in another jurisdiction for the same offense; is a juvenile who is handled by notifying the parents; when the victim refuses to prosecute; or another jurisdiction refuses to extradite the offender.

Clearances are counted as "adult" or "juvenile." A "juvenile" clearance is counted only when juveniles are exclusively involved in the commission and clearance of an offense. If the arrest of both adults and juveniles results in a clearance, it is counted as an "adult" clearance only.

Property Stolen and Recovered

The figures for value of property stolen and recovered report the value at each point in time. Although property can increase in value over time, it is more likely that stolen property will be recovered in a damaged condition. Therefore, recovery value does not necessarily represent a "clearance rate" for stolen property, and one cannot use it to determine law enforcement effectiveness in recovering stolen goods.

Because stolen and recovered property figures indicate thefts and recoveries in the current year, it is important to note that recovered property may have been stolen in a previous year. In addition, the type and value of stolen or recovered property is reported only for Part I offenses and does not include such Part II offenses as fraud, forgery or embezzlement.

Arrests

Arrest information is collected for all Part I and Part II offenses according to the age, sex, race, and ethnic origin of the offender. It is not possible, however, to correlate race or ethnic origin with the sex of the offender or specific ages because the information is collected independently, thus limiting analysis. Furthermore, arrest figures cannot be directly related to the number of crimes cleared because arrest totals count all the offenders who have been arrested even if several were involved in the commission of a single offense. Therefore, arrest and clearance totals will only be equal by coincidence.

It should be kept in mind that arrest totals do not indicate the number of different offenders involved in the commission of a crime. A total of four arrests may represent the arrest of four different offenders or the arrest of the same offender on four different occasions. Also, arrest totals do not indicate the number of charges placed against an offender at the time of the arrest.

Offense Definitions

Offenses in the Uniform Crime Reporting program are divided into two groupings, Part I and Part II. Information on the number of Part I offenses known to law enforcement, the number of clearances, and the number of persons arrested is reported each month. Only arrest data is reported for Part II offenses.

Part I Offenses

Criminal Homicide:

- a. **Murder and non-negligent manslaughter:**
The willful (non-negligent) killing of one human being by another. Deaths caused by negligence, attempts to kill, assaults to kill, suicides, accidental deaths and justifiable homicides are excluded. Justifiable homicides are limited to : (1) the killing of a felon by a peace officer in the line of duty, or (2) the killing (during the commission of a felony) of a felon by a private citizen.
- b. **Manslaughter by negligence:**
The killing of a person through gross negligence. Traffic fatalities are excluded. While manslaughter by negligence is a Part I offense, it is not included in the Crime Index total.

Forcible Rape:

The carnal knowledge of a female forcibly and against her will. Statutory rape (no force used and the victim is under the age of consent) is excluded.

Robbery:

The taking or attempting to take anything of value from the care, custody, or control of a person or persons by force or threat of force or violence and/or by putting the victim in fear.

Aggravated Assault:

The unlawful attack by one person upon another for the purpose of inflicting severe or aggravated bodily injury, usually accompanied by the use of a weapon or by means likely to produce death or great bodily harm. Simple assaults are excluded from this count.

Burglary:

The unlawful entry of a structure to commit a felony or theft.

Larceny-Theft:

The unlawful taking, carrying, leading, or riding away of property from the possession or constructive possession of another.

Motor Vehicle Theft:

The theft or attempted theft of a motor vehicle.

Arson:

The willful or malicious burning or attempt to burn, with or without intent to defraud.

Part II Offenses

Other (Simple) Assaults:

An unlawful attack or attempted attack upon another which does not result in serious injury to the victim and which does not involve the use of a dangerous weapon.

Forgery and Counterfeiting:

The making, altering, using, or possessing, with intent to defraud, anything false which is made to appear true.

Fraud:

Fraudulent conversion and obtaining money or property by false pretenses. Includes bad checks, confidence games, illegal conversion of services, etc., except forgeries and counterfeiting.

Embezzlement:

Misappropriation or misapplication of money or property entrusted to one's care, custody, or control. Includes attempts.

Stolen Property:

The buying, receiving, or possessing of stolen property, as well as all attempts to commit.

Vandalism:

The willful or malicious destruction, injury, disfigurement, or defacement of real or personal property without the consent of the owner or person having custody or control. Includes attempts.

Weapons:

All violations of regulations or statutes that control manufacturing, carrying, using, possessing, and furnishing deadly weapons or silencers. Includes attempts.

Prostitution and Commercialized Vice:

Sex offenses and attempted sex offenses of a commercial nature. Includes prostitution, keeping houses of ill fame, pandering, detaining women for immoral purposes, etc.

All Other Sex Offenses:

All other offenses against common decency and morals. Includes statutory rape, indecent exposure, incest, and any other sex offenses not previously defined.

Drug Abuse Violations:

The unlawful sale, manufacture, use or possession of controlled substances. For UCR purposes, these offenses are broken down into four subcategories: (a) Opium or cocaine and their derivatives (morphine, heroin, codeine), (b) Marijuana, (c) Synthetic narcotics--manufactured narcotics which can cause true drug addiction, and (d) Dangerous non-narcotic drugs.

Gambling:

Promoting, permitting, or engaging in illegal gambling. Includes bookmaking, number and lottery, etc.

Offenses Against the Family or Children:

All charges of nonsupport and neglect or abuse of family or children. Note: Most spousal or child abuse, especially that resulting in injury, has been classified as either simple or aggravated assault.

Driving Under the Influence:

Driving or operating any vehicle or common carrier while under the influence of alcohol or drugs.

Liquor Laws:

Violation of any state or local regulatory laws, including sale to minors and drinking on a public conveyance.

Disorderly Conduct:

All charges of committing a breach of the peace, including disturbing the peace, unlawful assembly, and drunk and disorderly.

Vagrancy:

Violation of state or local statutes pertaining to being a "suspicious character or person, etc." Includes vagrancy, begging, and loitering (persons over 18).

All Other Offenses:

All violations of state or local regulatory laws except traffic offenses and offenses defined above and below. Includes kidnapping, extortion, trespassing, possession of drug paraphernalia, etc.

Curfew and Loitering Laws:

Juvenile violations of local curfew or loitering ordinances.

Runaways (Juveniles):

The unlawful truancy from a legal place of residence by a juvenile.



**SUMMARY
OF STATE
CRIME DATA**

ARIZONA CRIME CLOCK 1996

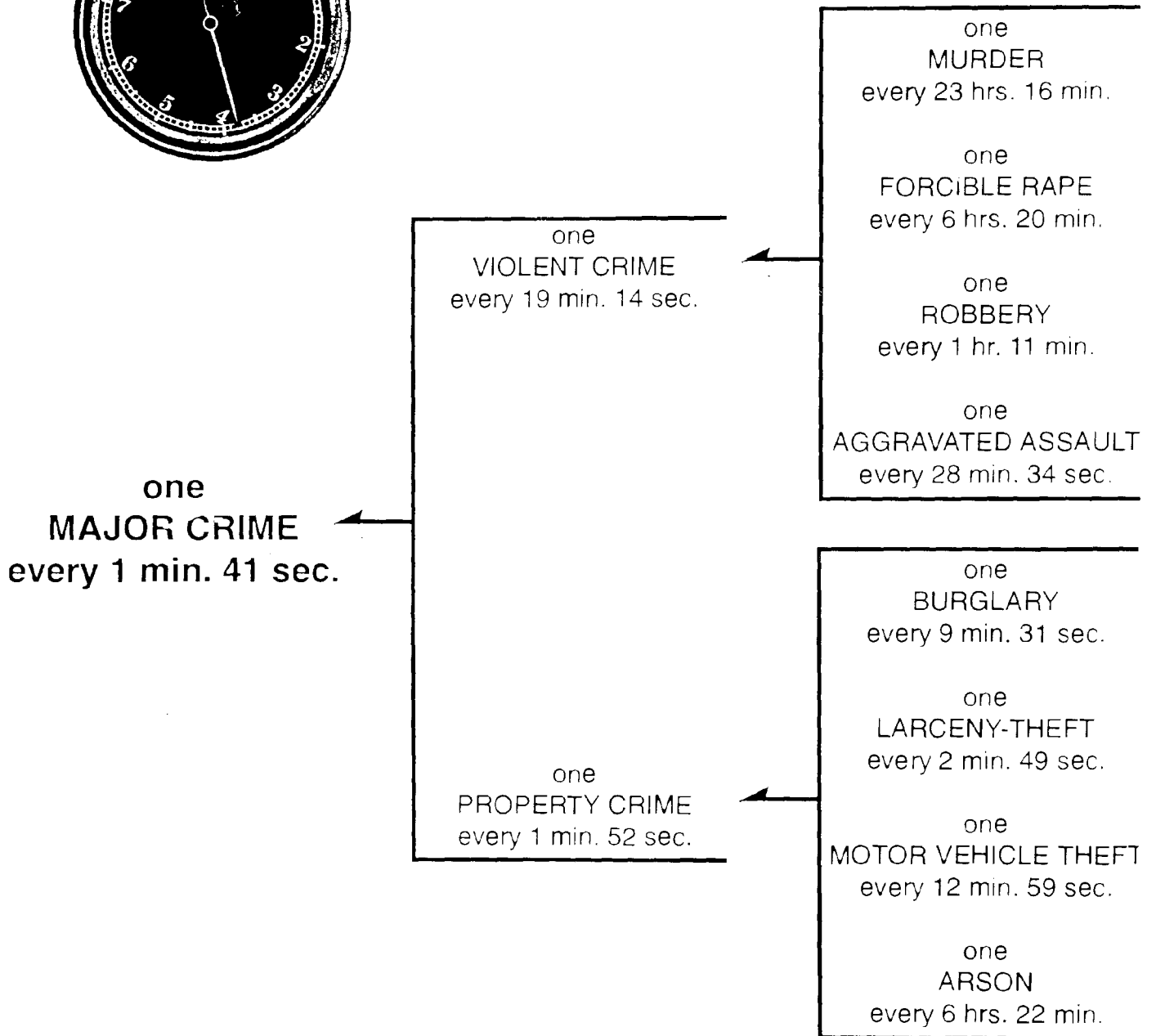
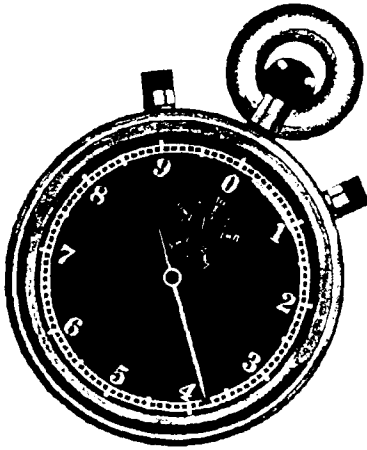

The crime clock should be viewed with care. Being the most aggregate representation of UCR data, it is designed to convey the annual reported crime experience by showing the relative frequency of occurrence of the Offenses. This mode of display should not be taken to imply a regularity in the commission of the Offenses; rather, it represents the annual ratio of crime to affixed time intervals.

ARIZONA CRIME CYCLE

The following represents the approximate number of Crime Index Offenses that were reported to Arizona law enforcement agencies every 24 hours during 1996.

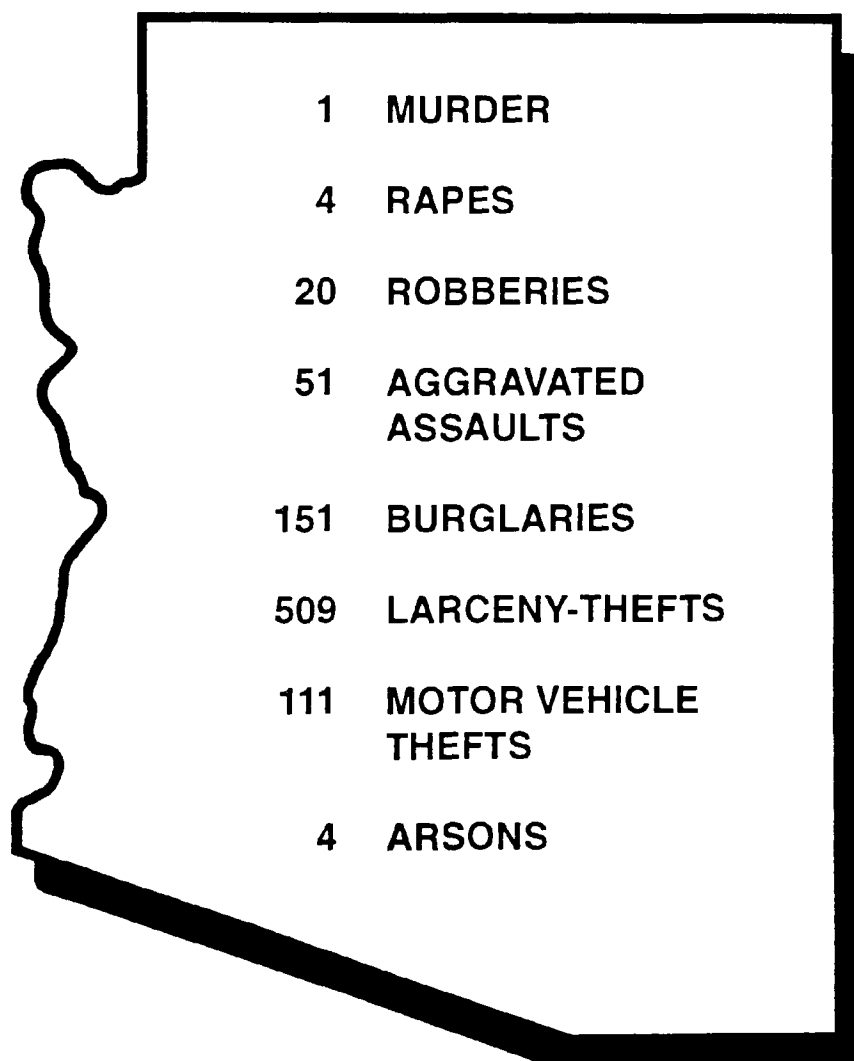

STATE CRIME SUMMARY

CRIME INDEX

- There were 310,757 Crime Index Offenses reported in 1996.
- October recorded the highest incidence of offenses with 27,680 reported while June recorded the lowest incidence of offenses with 24,141 reported.
- The value of property stolen amounted to \$365,495,091 in 1996.
- The value of property recovered amounted to \$145,278,474 for a recovery rate of 39.7 percent.
- Stolen motor vehicles accounted for 53.7 percent of the total stolen property and 91.4 percent of the total recovered property.
- The crime rate for 1996 for Arizona was 6,967.6 crimes per 100,000 population based on an estimated population of 4,462,300.

ARRESTS/CLEARANCES

- During 1996, a total of 60,336 persons were arrested for Index offenses.
- Adult Index arrests were 40,712 and juvenile arrests were 19,624.
- Males accounted for 76.2 percent of the Index arrests and females accounted for 23.8 percent.
- There were 59,532 clearances, or 19.2 percent, of Index Offenses reported in 1996. Juveniles represented 23.8 percent of this total.

VIOLENT CRIME SUMMARY

OFFENSES

- A total of 27,626 violent crimes were reported in 1996.
- Violent crimes accounted for 8.9 percent of the total Crime Index.
- The highest number of violent crimes were reported in March with 2,395 offenses while the lowest number was reported in November with 2,199 offenses.
- Aggravated assault accounted for the largest incidence of violent crimes with 18,509 offenses while homicide accounted for the smallest with 374 offenses.
- The value of property stolen was \$7,324,987.
- The crime rate was 619.4 offenses per 100,000 population.

ARRESTS/CLEARANCES

- There were 9,592 arrests for violent crimes in 1996.
- Adult arrests were 7,353 and juvenile arrests were 2,239.
- Males accounted for 86.3 percent and females accounted for 13.7 percent.
- There were 11,299 clearances, or 40.9 percent, of violent crimes reported in 1996. Juveniles represented 15.8 percent of this total.

PROPERTY CRIME SUMMARY

OFFENSES

- A total of 283,131 property crimes were reported in 1996.
- Property crimes accounted for 91.1 percent of the total Crime Index.
- The highest number of property crimes were reported in October with 25,295 offenses while the lowest number was reported in June with 21,842 offenses.
- Larceny-theft accounted for the largest incidence of property crimes with 185,905 offenses while arson accounted for the smallest with 1,373 offenses.
- The value of property stolen was \$358,170,104.
- The crime rate was 6,348.2 offenses per 100,000 population.

ARRESTS/CLEARANCES

- There were 50,744 arrests for property crimes in 1996.
- Adult arrests were 33,359 and juvenile arrests were 17,385.
- Males accounted for 74.3 percent and females accounted for 25.7 percent.
- There were 48,233 clearances, or 17.0 percent, of property crimes reported in 1996. Juveniles represented 25.6 percent of this total.

TOTAL ARREST SUMMARY

- There were 315,134 persons arrested in 1996.
- Adult arrests were 242,088 and juvenile arrests were 73,046.
- Males accounted for 78.6 percent and females accounted for 21.4 percent.
- Part I offenses accounted for 60,336 arrests.
- Part II offenses accounted for 254,798 arrests.

CRIME INDEX FOR THE STATE - 1996

OFFENSES	NUMBER OF INDEX OFFENSES	PERCENT DISTRIBUTION	NUMBER OF OFFENSES CLEARED	PERCENT OF OFFENSES CLEARED
MURDER	374	0.1	224	59.9
FORCIBLE RAPE	1,383	0.4	490	35.4
Rape	1,136	0.3	431	37.9
Attempted Rape	247	0.1	59	23.9
ROBBERY	7,360	2.4	1,670	22.7
Firearm	2,885	0.9	693	24.0
Knife or Cutting Instrument	712	0.2	165	23.2
Other Dangerous Weapon	742	0.3	159	21.4
Strong Arm (Hands, Fists, etc.)	3,021	1.0	653	21.6
AGGRAVATED ASSAULT	18,509	6.0	8,915	48.2
Firearm	6,084	2.0	2,036	33.5
Knife or Cutting Instrument	2,742	0.9	1,491	54.4
Other Dangerous Weapon	5,063	1.6	2,657	52.5
Strong Arm (Hands, Fists, etc.)	4,620	1.5	2,731	59.1
BURGLARY	55,247	17.8	4,752	8.6
Forcible Entry	32,371	10.4	2,702	8.3
Unlawful Entry - No Force	19,148	6.2	1,748	9.1
Attempted Forcible Entry	3,728	1.2	302	8.1
LARCENY-THEFT	185,905	59.8	38,558	20.7
MOTOR VEHICLE THEFT	40,606	13.1	4,644	11.4
Automobiles	26,809	8.6	3,256	12.1
Trucks and Buses	11,764	3.8	1,154	9.8
Other Vehicles	2,033	0.7	234	11.5
ARSON	1,373	0.4	279	20.3
TOTAL CRIME INDEX	310,757	100.0	59,532	19.2
VIOLENT CRIME	27,626	8.9	11,299	40.9
PROPERTY CRIME	283,131	91.1	48,233	17.0

INDEX CRIME COMPARISON*

INDEX OFFENSES		Number of Offenses	Number of Offenses Cleared	Percent of Offenses Cleared
Murder	1995	433	255	58.89
	1996	369	221	59.89
	Percent Change	-14.78	-13.33	+1.70
Forcible Rape	1995	1,365	411	30.11
	1996	1,344	472	35.12
	Percent Change	-1.54	+14.84	+16.64
Robbery	1995	7,091	1,608	22.68
	1996	7,269	1,646	22.64
	Percent Change	+2.51	+2.36	-0.18
Aggravated Assault	1995	20,066	8,905	44.38
	1996	17,920	8,505	47.46
	Percent Change	-10.69	-4.49	+6.94
Burglary	1995	57,073	4,733	8.29
	1996	53,467	4,535	8.48
	Percent Change	-6.32	-4.18	+2.29
Larceny-Theft	1995	200,420	38,256	19.09
	1996	181,302	37,418	20.64
	Percent Change	-9.54	-2.19	+8.12
Motor Vehicle Theft	1995	47,577	5,640	11.85
	1996	40,073	4,523	11.29
	Percent Change	-15.77	-19.80	-4.73
Arson	1995	1,512	279	18.45
	1996	1,332	261	19.59
	Percent Change	-11.90	-6.45	+6.18
TOTAL INDEX CRIMES	1995	335,537	60,087	17.91
	1996	303,076	57,581	19.00
	Percent Change	-9.67	-4.17	+6.09

*For the purposes of this comparison chart only, the statistics from the following agencies have been excluded as they were unable to provide complete data for 1995 and/or 1996: Avondale PD, Clarkdale PD, Clifton PD, Colorado City MO, Douglas PD, Eloy PD, Fredonia MO, La Paz County SO, Oro Valley PD, Page PD, Parker PD, Patagonia MO, St. Johns PD, Tombstone MO, Williams PD, Yuma County SO, and Yuma PD.

The 1995 figures will vary from previously published statistics as additional information was provided by contributing agencies.

For complete statistical information, please contact the Access Integrity Unit at (602)223-2263.

VALUE OF PROPERTY LOSS BY OFFENSE

OFFENSE	Number of Offenses	Dist.	(\$) Value of Property Stolen	Dist.	Average (\$) Value
Murder	374	0.1%	46,880	0.01%	125.35
Forcible Rape	1,383	0.5%	85,620	0.02%	61.91
Robbery	7,360	2.5%	7,192,487	1.97%	977.24
Burglary	55,247	19.0%	80,100,601	21.92%	1,449.86
Larceny-Theft	185,905	63.9%	82,409,285	22.55%	443.29
Motor Vehicle Theft*	40,606	14.0%	195,660,218	53.53%	4,818.51
TOTAL	290,875	100.0%	\$365,495,091	100.00%	\$1,256.54

*Motor vehicles that were stolen in conjunction with a more "serious" index offense such as robbery or burglary are not included in this count. This count represents only those instances in which motor vehicle theft was the only or most "serious" offense committed. The total value shown here reflects the value of all property stolen during the commission of the offense (i.e., not just the value of each vehicle).

TYPE AND VALUE OF PROPERTY STOLEN/RECOVERED

TYPE OF PROPERTY	(\$) Value Stolen	Dist.	(\$) Value Recovered	Percent Recovered
Currency and Notes	13,200,783	3.6%	1,661,167	12.6%
Jewelry and Precious Metals	26,237,747	7.2%	953,962	3.6%
Clothing and Furs	4,535,402	1.2%	621,097	13.7%
Locally Stolen Motor Vehicles	196,219,736	53.7%	132,808,792	67.7%
Office Equipment	15,659,374	4.3%	753,319	4.8%
TVs, Radios, Cameras, Etc.	31,432,217	8.6%	1,170,360	3.7%
Firearms	3,882,605	1.1%	417,198	10.7%
Household Goods	6,871,642	1.9%	235,277	3.4%
Consumable Goods	1,294,910	0.3%	283,333	21.9%
Livestock	97,433	0.1%	8,138	8.4%
Miscellaneous	66,063,242	18.0%	6,365,831	9.6%
TOTAL	\$365,495,091	100.0%	\$145,278,474	39.7%

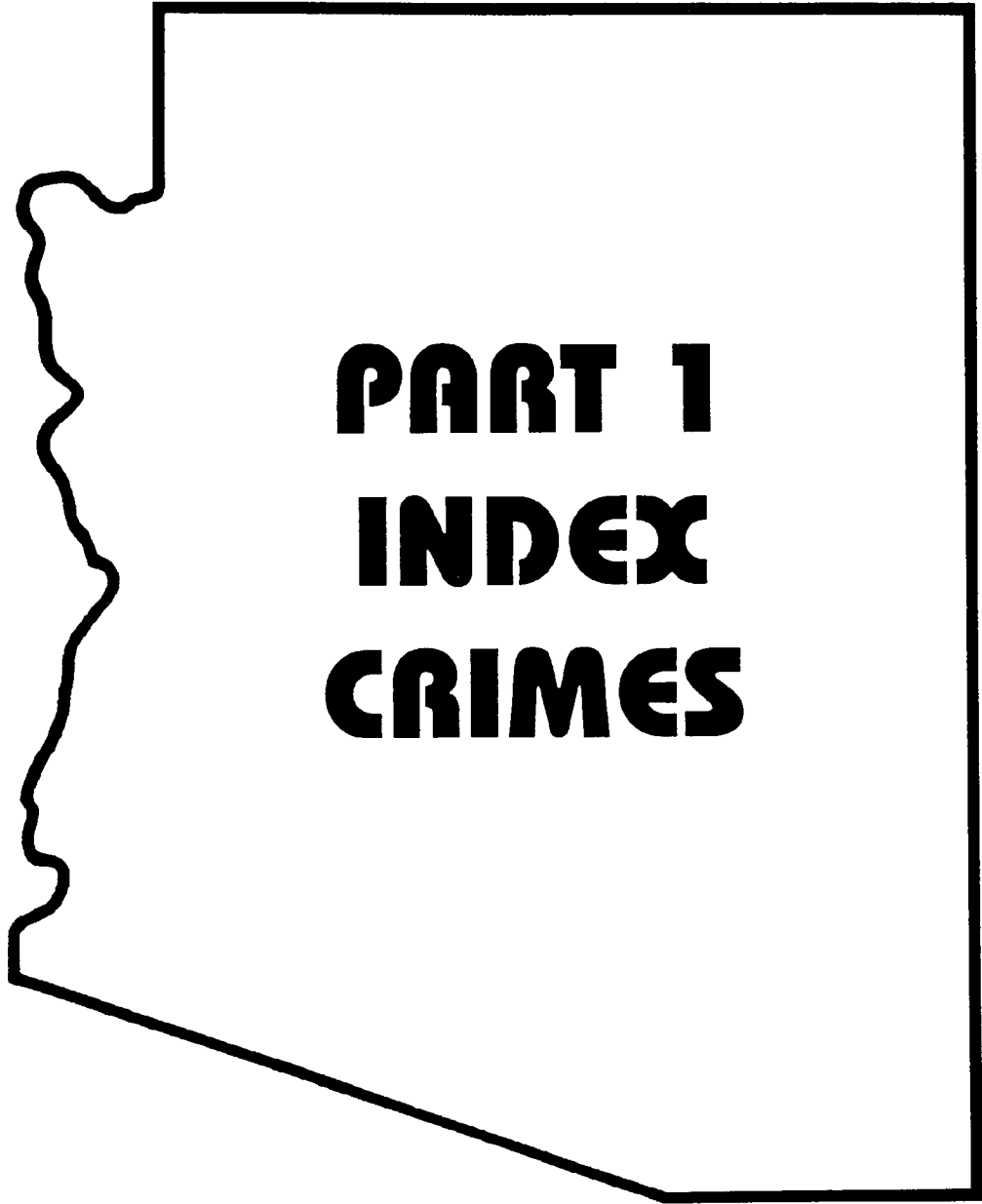

VIOLENT CRIMES

- **Murder**
- **Rape**
- **Robbery**
- **Aggravated Assault**

PROPERTY CRIMES

- **Burglary**
- **Larceny-Theft**
- **Motor Vehicle Theft**
- **Arson**

MURDER AND NONNEGLIGENT MANSLAUGHTER

DEFINITION

Murder is defined as the willful (nonnegligent) killing of one person by another. As a general rule, any death due to injuries received in a fight, argument, quarrel, assault, or commission of a crime would be included. Attempted murders and assaults to murder are classified as aggravated assaults. Suicides, traffic fatalities, accidental deaths, negligent manslaughters, and justifiable homicides are not counted under this classification.

SUMMARY

- There were 374 murders reported during 1996.
- Murder accounted for 0.1 percent of the total Index offenses and 1.4 percent of the total violent crimes.
- March recorded the highest number, with 41, while July recorded the lowest with 20.
- Saturday reported the highest incidence of murders, with 66, while Wednesday was the lowest with 39.
- The time period of 6:01 PM - 2:00 AM recorded the highest number of murders, with 167, while 10:01 AM - 6:00 PM was the lowest with 90.
- Firearms (including handguns, rifles, shotguns, etc.) were used in 74.3 percent of the murders.
- In murders where the relationship between the victim and offender was known, 23 percent were acquaintances.
- The total value of property stolen amounted to \$46,880.

ARRESTS/CLEARANCES

- A total of 260 persons were arrested in 1996.
- Adults accounted for 214 arrests and juveniles accounted for 46 arrests.
- Males accounted for 228 arrests, or 87.7 percent, and females accounted for 32 arrests, or 12.3 percent.
- Of those persons arrested, 80.8 percent were white, 13.4 percent were black, and 5.8 percent were other races.
- Hispanics accounted for 35.8 percent of the arrests.
- There were 224 clearances for murder reported in 1996. Juveniles represented 4.5 percent of this total.

MURDER BY MONTH

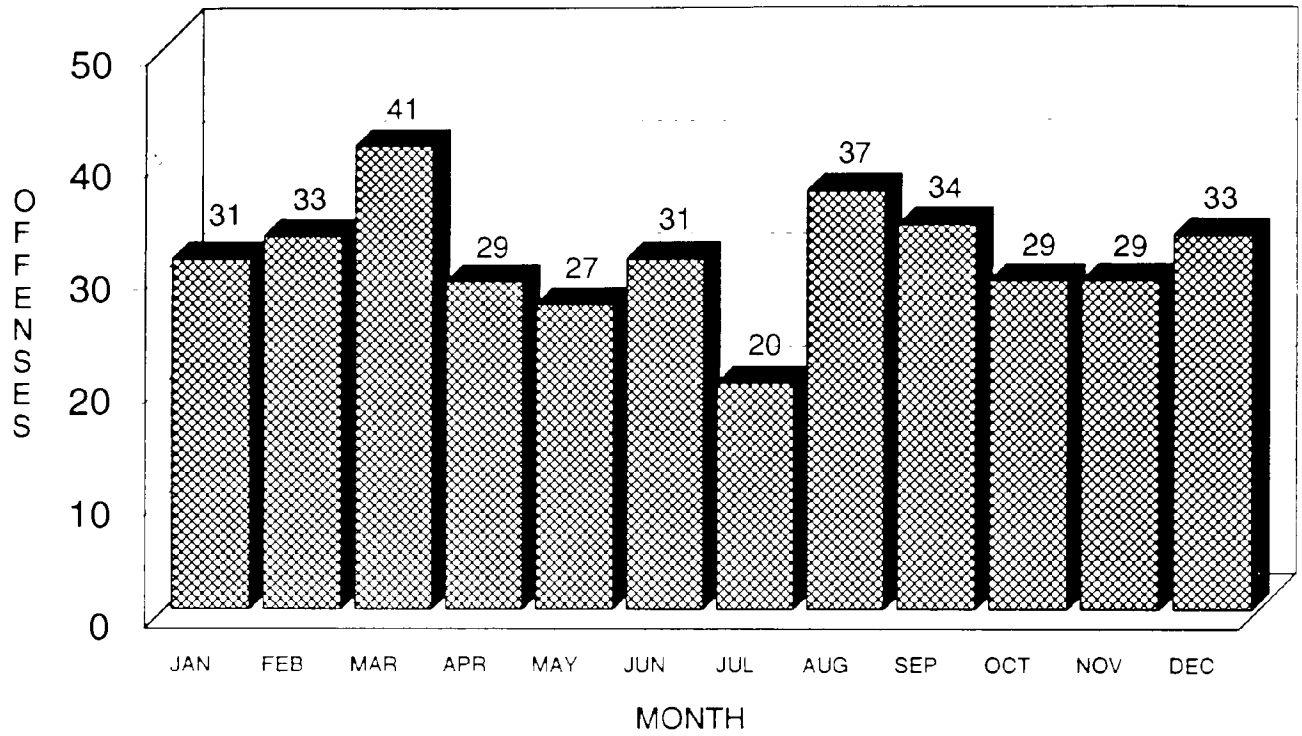

MURDER BY DAY OF WEEK

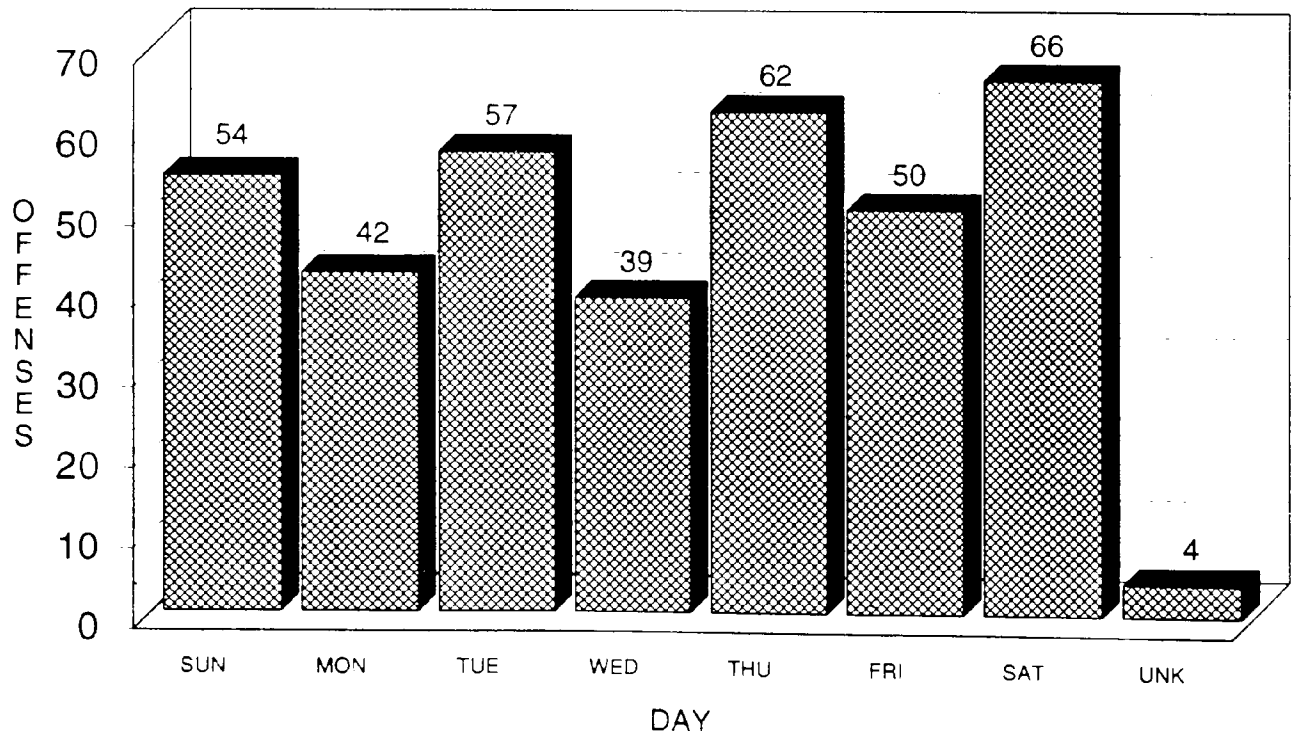

[REDACTED]

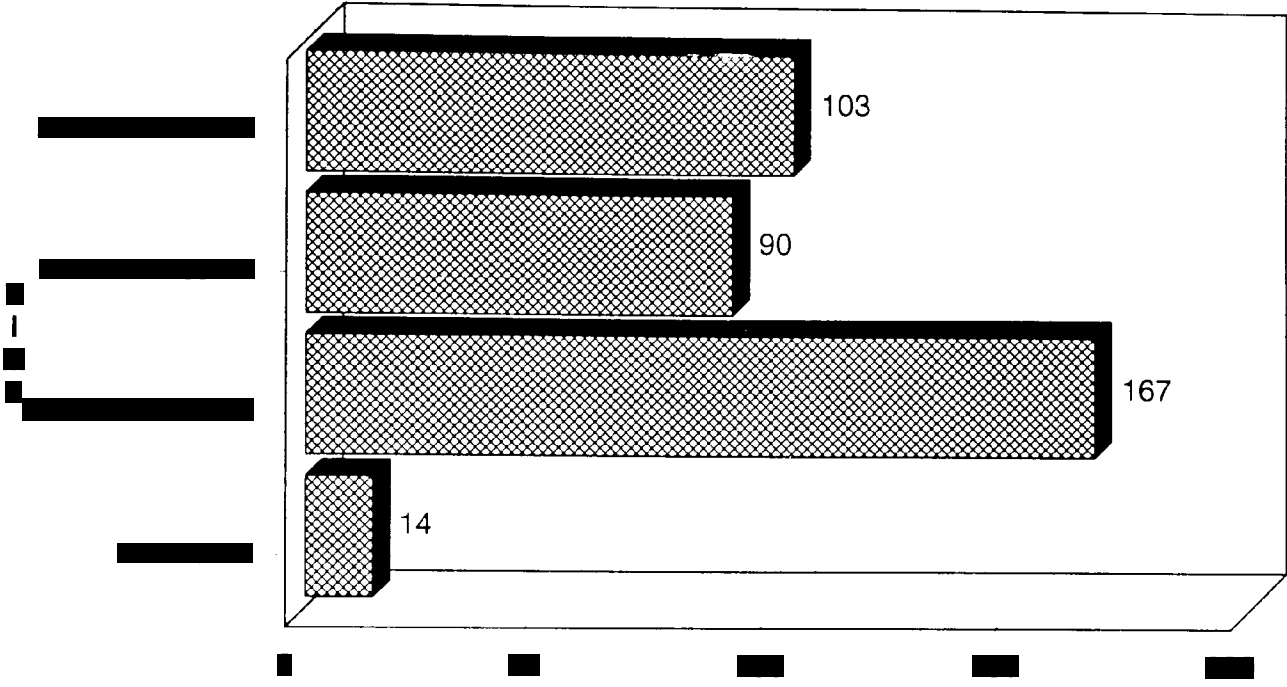

[REDACTED]

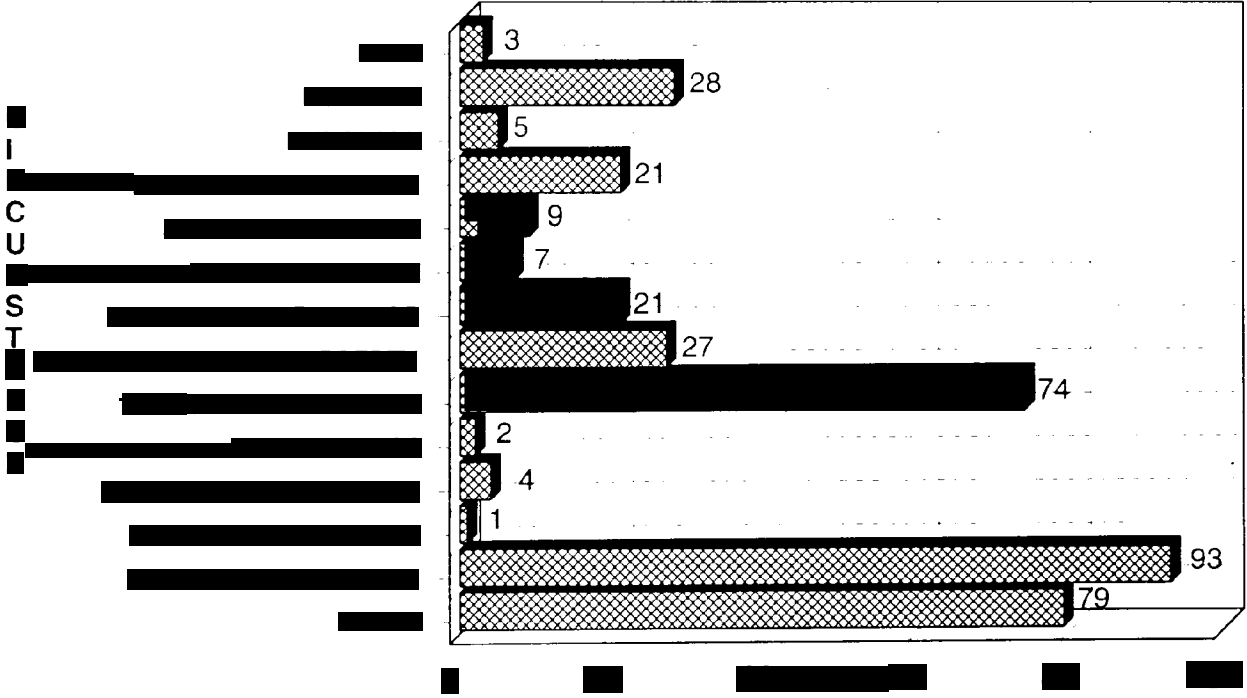

MURDER BY TYPE OF WEAPON USED

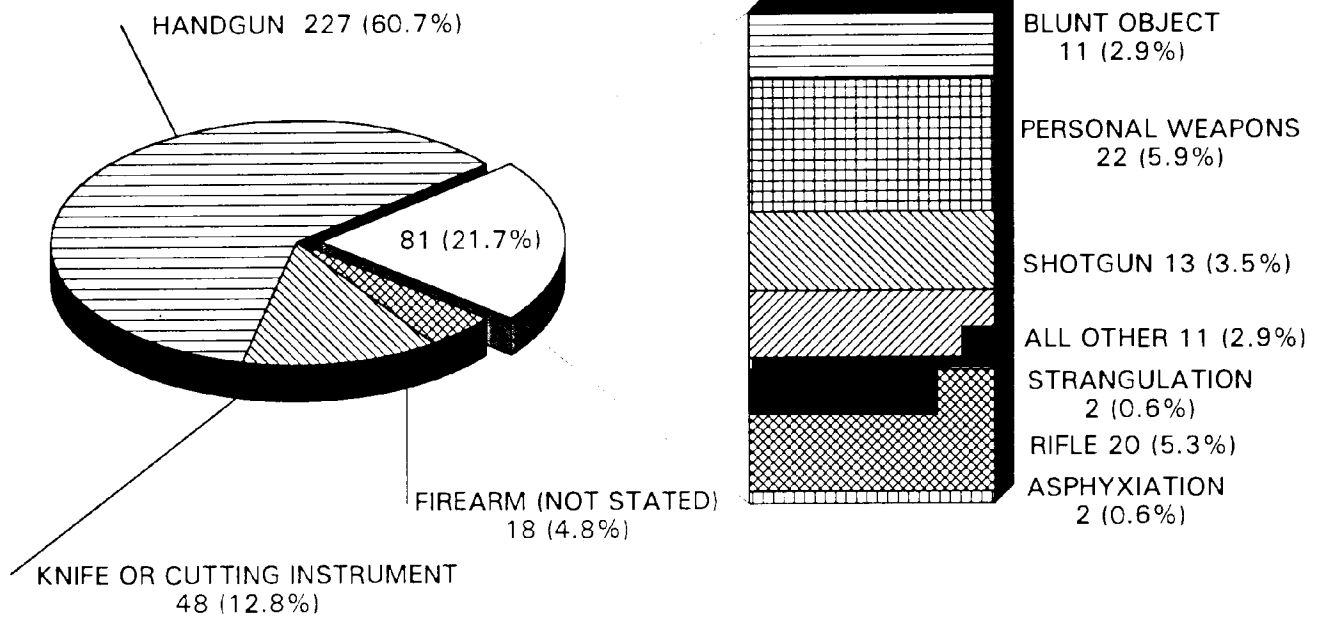

MURDER DISTRIBUTION BY RELATIONSHIP

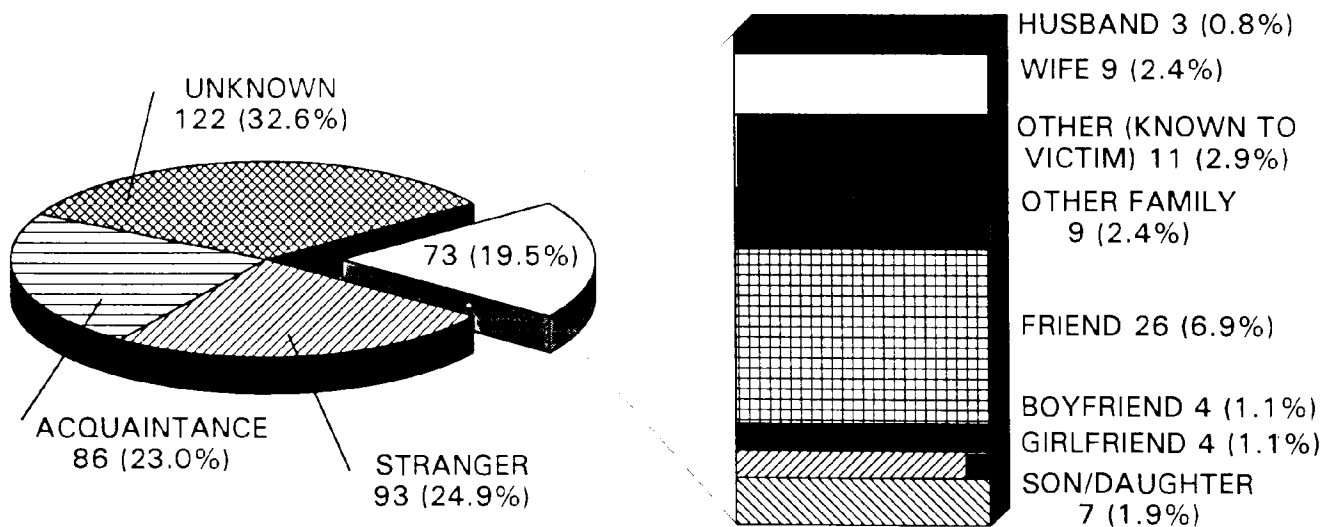

MURDER VICTIM BY AGE, SEX, RACE & ETHNIC ORIGIN

AGE	NUMBER	DIST.	SEX		RACE				ETHNIC ORIGIN	
			MALE	FEMALE	WHITE	BLACK	INDIAN	ASIAN	HISPANIC	NOT HISPANIC
Infant	6	1.6%	4	2	4	2	--	--	3	3
1-4	7	1.9%	5	2	7	--	--	--	2	5
5-9	4	1.1%	2	2	4	--	--	--	1	3
10-14	6	1.6%	4	2	5	--	1	--	2	4
15-19	58	15.5%	52	6	47	10	1	--	38	20
20-24	61	16.3%	55	6	53	8	--	--	40	21
25-29	47	12.6%	38	9	34	9	4	--	22	25
30-34	46	12.3%	36	10	39	6	1	--	23	23
35-39	36	9.6%	30	6	30	3	3	--	17	19
40-44	29	7.8%	25	4	26	3	--	--	15	14
45-49	20	5.3%	15	5	17	2	1	--	7	13
50-54	20	5.3%	14	6	17	1	2	--	8	12
55-59	7	1.9%	5	2	6	1	--	--	2	5
60-64	6	1.6%	5	1	6	--	--	--	1	5
65-69	6	1.6%	2	4	6	--	--	--	1	5
70-74	4	1.1%	1	3	3	1	--	--	1	3
75+	5	1.3%	3	2	3	2	--	--	--	5
Unknown	6	1.6%	6	--	5	1	--	--	4	2
TOTAL	374	--	302	72	312	49	13	--	187	187
Distribution	--	100.0%	80.7%	19.3%	83.4%	13.1%	3.5%	0.0%	50.0%	50.0%
Adult	324	86.6%	260	64	271	42	11	--	163	161
Juvenile	44	11.8%	36	8	36	6	2	--	20	24
Unknown	6	1.6%	6	--	5	1	--	--	4	2

FORCIBLE RAPE

DEFINITION

Forcible rape is defined as the carnal knowledge of a female through the use of force or threat of force. Assaults or attempts to commit forcible rape are also included; however, statutory rape (without force) and other sex offenses are not counted in this category. By definition, sex attacks on males are excluded and are classified as assaults or "other sex offenses" depending on the nature of the crime and the extent of injury.

SUMMARY

- There were 1,383 rapes reported during 1996.
- Rape accounted for 0.4 percent of the total Index offenses and 5.0 percent of violent crimes.
- October recorded the highest number, with 144, while December recorded the lowest with 100.
- Of the total rapes reported, forcible rape accounted for 1,136 offenses and attempted rape accounted for 247 offenses.
- The total value of property stolen amounted to \$85,620.

ARRESTS/CLEARANCES

- A total of 266 persons were arrested in 1996.
- Adults accounted for 228 arrests and juveniles accounted for 38 arrests.
- Of those persons arrested, 74.8 percent were white, 21.4 percent were black, and 3.8 percent were other races.
- Hispanics accounted for 35.0 percent of the arrests.
- There were 490 clearances for rape reported in 1996. Juveniles represented 7.6 percent of this total.

RAPE BY MONTH (Total Offenses)

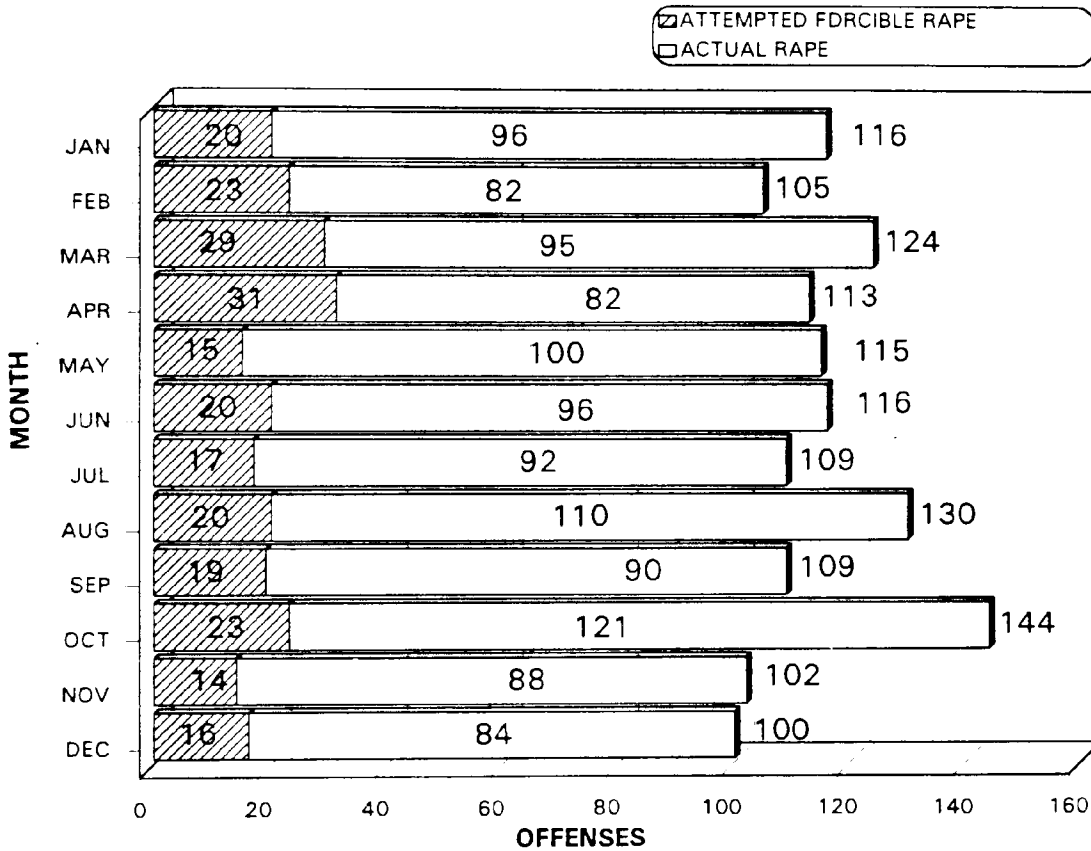

ROBBERY

DEFINITION

Robbery is defined as the taking or attempting to take anything of value from the care, custody, or control of a person by force or threat of force and/or by putting the victim in fear. Robbery involves a theft or larceny but is aggravated by the element of force or threat of force.

SUMMARY

- There were 7,360 robberies reported during 1996.
- Robbery accounted for 2.4 percent of the total Index offenses and 26.6 percent of the violent crimes.
- October recorded the highest number, with 713, while April recorded the lowest with 539.
- Robberies occurring on highways (streets, alleys, and sidewalks) recorded the highest number, with 3,916 or 53.2 percent of all robberies.
- Gas or service station robberies had the lowest number, with 147, or 2.0 percent of all robberies.
- The number of bank robberies reported in 1996 increased 60.0 percent over 1995.
- The total value of property stolen amounted to \$7,192,487.
- Robberies occurring on highways (streets, alleys, and sidewalks) had the highest total dollar loss, with \$3,687,663.
- Bank robberies had the highest dollar loss per robbery, with \$4,131.
- Firearms represented the most common weapon used in 2,885 robberies, or 39.2 percent.

ARRESTS/CLEARANCES

- A total of 1,659 persons were arrested in 1996.
- Adults accounted for 1,173 arrests and juveniles accounted for 486 arrests.
- Males accounted for 1,518 arrests, or 91.5 percent, and females accounted for 141 arrests, or 8.5 percent.
- Of those persons arrested, 69.3 percent were white, 26.8 percent were black, and 3.9 percent were other races.
- Hispanics accounted for 35.6 percent of the arrests.
- There were 1,670 clearances for robbery reported in 1996. Juveniles represented 16.3 percent of this total.

ROBBERY BY LOCATION & VALUE

	NUMBER OF OFFENSES	DISTRIBUTION(%)	TOTAL DOLLAR VALUE STOLEN	AVERAGE DOLLAR VALUE STOLEN
Highway	3,916	53.2%	\$3,687,663	\$942
Commercial House	1,004	13.6%	1,005,757	1,002
Gas or Service Station	147	2.0%	127,595	868
Convenience Store	817	11.1%	158,803	194
Residence	668	9.1%	737,912	1,105
Bank	265	3.6%	1,094,777	4,131
Miscellaneous	543	7.4%	379,980	700
TOTAL	7,360	100.0%	\$7,192,487	\$977

ROBBERY BY MONTH & WEAPON USED

WEAPON	TOTAL	JAN	FEB	MAR	APR	MAY	JUN	JUL	AUG	SEP	OCT	NOV	DEC
Firearm	2,885	259	275	298	198	216	217	212	203	200	284	274	249
Knife or Cutting Instrument	712	52	57	42	57	46	60	54	64	74	74	74	58
Other Dangerous Weapons	742	53	53	56	49	56	60	55	72	72	69	73	74
Strong Arm	3,021	245	244	252	235	230	247	233	259	234	286	270	286
TOTAL	7,360	609	629	648	539	548	584	554	598	580	713	691	667

AGGRAVATED ASSAULT

DEFINITION

Aggravated assault is defined as the unlawful attack by one person upon another for the purpose of inflicting severe or aggravated bodily injury. This type of assault usually is accompanied by the use of a weapon or means likely to produce death or serious bodily harm.

SUMMARY

- There were 18,509 aggravated assaults reported during 1996.
- **Aggravated assault** accounted for 6.0 percent of the total Index offenses and 67.0 percent of the violent crimes.
- July recorded the highest number, with 1,638, while November recorded the lowest with 1,377.
- Firearms represented the most common weapon used in 6,084 aggravated assaults, or 32.9 percent.
- Physical force (hands, fists, etc.) was used in 25.0 percent, and other dangerous weapons were used in 27.3 percent of reported aggravated assaults.
- There were 52,269 simple assaults reported in 1996. Simple assault is primarily differentiated from aggravated assault by the seriousness of the injury and the weapon used. Simple assault is not a Crime Index offense but is reported here for the purpose of showing the total assault violence.

ARRESTS/CLEARANCES

- A total of 7,407 persons were arrested in 1996.
- Adults accounted for 5,738 arrests and juveniles accounted for 1,669 arrests.
- Males accounted for 6,270 arrests, or 84.6 percent, and females accounted for 1,137 arrests, or 15.4 percent.
- Of those persons arrested, 82.2 percent were white, 11.4 percent were black, and 6.4 percent were other races.
- Hispanics accounted for 31.4 percent of the arrests.
- There were 8,915 clearances for aggravated assault reported in 1996. Juveniles represented 16.4 percent of this total.

[REDACTED]

[REDACTED]

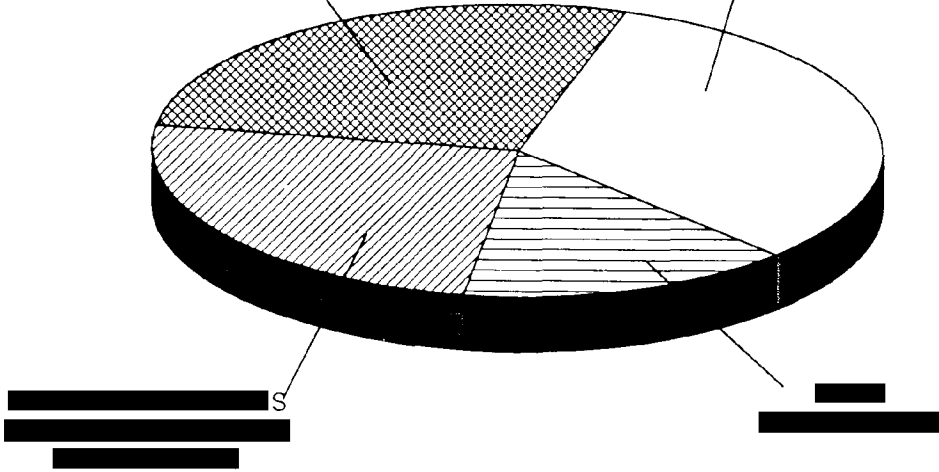

ASSAULT BY MONTH

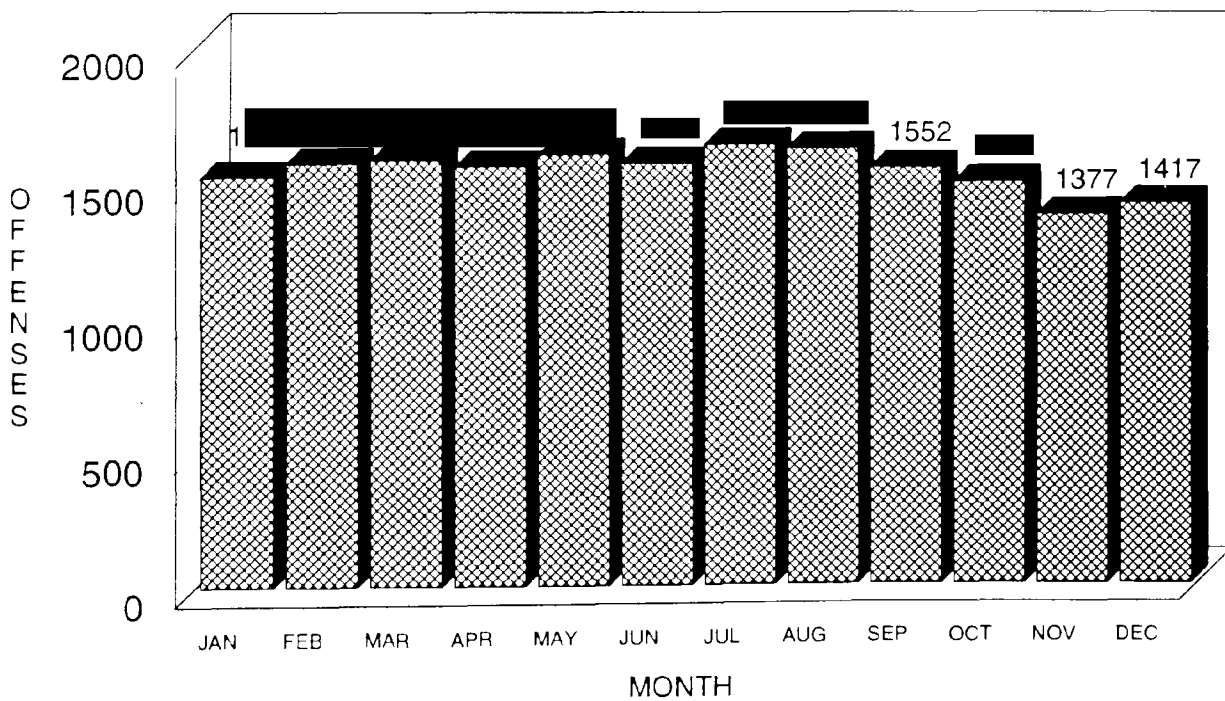

BURGLARY

DEFINITION

Burglary is defined as the unlawful entry of a structure to commit a felony or theft. The use of force to gain entry is not required to classify the crime as a burglary. A structure is considered to include, but not limited to, the following: dwelling houses, apartments, public buildings, offices, barns, cabins, etc. Burglary is divided into three subclassifications: forcible entry, unlawful entry where no force is used, and attempted forcible entry.

SUMMARY

- There were 55,247 burglaries reported during 1996.
- Burglary accounted for 17.8 percent of the total Index offenses and 19.5 percent of the property crimes.
- December recorded the highest number, with 5,126, while June recorded the lowest with 4,204.
- Forcible entry was used in 32,371, or 58.6 percent of the total burglaries.
- Residential burglaries accounted for 39,170, or 70.9 percent of the total burglaries.
- In burglaries where the time of occurrence was known, 15,830, or 28.6 percent occurred between the hours of 6 AM - 6 PM.
- The total value of property stolen amounted to \$80,100,601.
- Residential burglaries accounted for the highest property loss, \$57,240,082.

ARREST/CLEARANCES

- A total of 6,345 persons were arrested in 1996.
- Adults accounted for 3,383 arrests and juveniles accounted for 2,962 arrests.
- Males accounted for 5,771 arrests, or 91.0 percent, and females accounted for 574 arrests, or 9.0 percent.
- Of those persons arrested, 86.1 percent were white, 9.9 percent were black, and 4.0 percent were other races.
- Hispanics accounted for 32.9 percent of the arrests.
- There were 4,752 clearances for burglary reported in 1996. Juveniles represented 27.9 percent of this total.

BURGLARY BY LOCATION & TIME

LOCATION	NUMBER OF OFFENSES	DISTRIBUTION	VALUE STOLEN	AVERAGE VALUE STOLEN
RESIDENCE				
Night (6PM-6AM)	8,065	14.6%	\$8,853,358	\$1,098
Day (6AM-6PM)	13,497	24.4%	20,613,267	1,527
Unknown	17,608	31.9%	27,773,457	1,577
SUBTOTAL	39,170	70.9%	\$57,240,082	\$1,461
NON-RESIDENCE				
Night (6PM-6AM)	5,568	10.1%	\$6,083,391	\$1,093
Day (6AM-6PM)	2,333	4.2%	2,139,196	917
Unknown	8,176	14.8%	14,637,932	1,790
SUBTOTAL	16,077	29.1%	\$22,860,519	\$1,422
TOTAL	55,247	100.0%	\$80,100,601	\$1,450

BURGLARY BY MONTH & MEANS OF ENTRY

ENTRY TYPE	TOTAL	JAN	FEB	MAR	APR	MAY	JUN	JUL	AUG	SEP	OCT	NOV	DEC
Forcible Entry	32,371	2,857	2,723	2,713	2,458	2,559	2,374	2,708	2,695	2,601	2,956	2,620	3,107
Unlawful Entry- No Force	19,148	1,516	1,508	1,596	1,683	1,540	1,520	1,613	1,730	1,632	1,637	1,474	1,699
Attempted Forcible Entry	3,728	312	286	328	312	291	310	323	318	283	325	320	320
TOTAL	55,247	4,685	4,517	4,637	4,453	4,390	4,204	4,644	4,743	4,516	4,918	4,414	5,126

LARCENY-THEFT

DEFINITION

Larceny-Theft is defined as the unlawful taking, carrying, leading, or riding away of property or articles from the possession or constructive possession of another without the use of force, violence, or fraud. This crime category does not include embezzlement, fraud, counterfeiting, or worthless checks.

SUMMARY

- There were 185,905 larceny-thefts reported during 1996.
- Larceny-theft accounted for 59.8 percent of the total Index offenses and 65.7 percent of the property crimes.
- January recorded the highest number, with 16,575, while June was the lowest with 14,441.
- Larceny-theft in the under \$50 category reported the highest number of incidents, with 80,111, or 43.1 percent.
- Shoplifting accounted for 39,782 larceny-thefts or 21.4 percent.
- The total value of property stolen amounted to \$82,409,285.

ARRESTS/CLEARANCES

- A total of 40,785 persons were arrested in 1996.
- Adults accounted for 28,241 arrests and juveniles accounted for 12,544 arrests.
- Males accounted for 28,800 arrests, or 70.6 percent and females accounted for 11,985 arrests, or 29.4 percent.
- Of those persons arrested, 82.8 percent were white, 10.4 percent were black, and 6.8 percent were other races.
- Hispanics accounted for 28.9 percent of the arrests.
- There were 38,558 clearances for larceny-theft reported in 1996. Juveniles represented 24.9 percent of this total.

LARCENY-THEFT BY TYPE BY MONTH

CLASSIFICATION	TOTAL	DIST.	JAN	FEB	MAR	APR	MAY	JUN	JUL	AUG	SEP	OCT	NOV	DEC
Pocket Picking	409	0.2%	65	38	32	25	22	30	42	24	31	32	31	37
Purse Snatching	630	0.3%	66	43	49	47	44	63	49	57	43	56	54	59
Shoplifting	39,782	21.5%	3,633	3,389	3,555	3,162	3,074	3,100	3,246	3,418	2,946	3,393	3,322	3,544
From Motor Vehicles	37,969	20.4%	3,634	3,291	3,054	2,952	2,911	2,901	2,907	3,149	2,988	3,537	3,176	3,469
Motor Vehicle Parts and/or Accessories	30,911	16.6%	2,628	2,762	2,720	2,380	2,586	2,402	2,434	2,486	2,534	2,921	2,567	2,491
Bicycles	12,804	6.9%	1,016	1,095	1,073	1,086	1,096	1,062	1,109	1,106	1,201	1,178	863	919
From Buildings	14,880	8.0%	1,252	1,163	1,153	1,208	1,256	1,161	1,277	1,255	1,278	1,292	1,240	1,345
From Coin-Operated Machines	1,073	0.6%	131	131	79	89	57	77	110	80	67	102	79	71
All Other	47,447	25.5%	4,150	3,777	4,018	4,033	4,165	3,645	4,045	4,101	3,975	3,991	3,514	4,033
TOTAL	185,905	100.0%	16,575	15,689	15,733	14,982	15,211	14,441	15,219	15,676	15,063	16,502	14,846	15,968

LARCENY-THEFT BY VALUE BY MONTH

VALUE	TOTAL	DIST.	JAN	FEB	MAR	APR	MAY	JUN	JUL	AUG	SEP	OCT	NOV	DEC
Over \$200	68,913	37.1%	6,107	5,946	5,735	5,459	5,350	5,253	5,741	5,464	5,545	6,308	5,931	6,074
\$50 to \$200	36,881	19.8%	3,173	3,049	3,131	3,012	3,135	2,800	2,841	3,404	2,887	3,249	2,967	3,233
Under \$50	80,111	43.1%	7,295	6,694	6,867	6,511	6,726	6,388	6,637	6,808	6,631	6,945	5,948	6,661
TOTAL	185,905	100.0%	16,575	15,689	15,733	14,982	15,211	14,441	15,219	15,676	15,063	16,502	14,846	15,968

LARCENY-THEFT BY CLASSIFICATION & VALUE

CLASSIFICATION BY VALUE OF PROPERTY STOLEN	NUMBER OF OFFENSES	TOTAL VALUE STOLEN	AVERAGE VALUE	PERCENT DISTRIBUTION (VALUE)
\$200 and Over	68,913	\$76,544,456	1,111	92.9%
\$50 to \$200	36,881	4,290,280	116	5.2%
Under \$50	80,111	1,574,549	20	1.9%
TOTAL	185,905	\$82,409,285	\$443	100.0%

ADDITIONAL ANALYSIS OF LARCENY-THEFT

CLASSIFICATION	NUMBER OF OFFENSES	TOTAL VALUE STOLEN	AVERAGE VALUE	PERCENT DISTRIBUTION (VALUE)
Pocket Picking	409	\$115,972	\$284	0.1%
Purse Snatching	630	181,936	289	0.2%
Shoplifting	39,782	2,260,695	57	2.7%
From Motor Vehicles	37,969	18,815,144	496	22.8%
Motor Vehicle Parts and/or Accessories	30,911	12,510,920	405	15.2%
Bicycles	12,804	3,945,619	308	4.8%
From Buildings	14,880	10,101,100	679	12.3%
From Coin-Operated Machines	1,073	196,133	183	0.3%
All Other	47,447	34,281,766	723	41.6%
TOTAL	185,905	\$82,409,285	\$443	100.0%

MOTOR VEHICLE THEFT

DEFINITION

Motor Vehicle Theft is defined as the unlawful taking or stealing of a motor vehicle including attempts and joyriding. This definition excludes the taking for temporary use by those persons having lawful access to the vehicle. For UCR purposes, a motor vehicle is defined as a self-propelled vehicle that runs on land and not on rails. Farm equipment, bulldozers, airplanes, construction equipment, and motorboats are excluded.

SUMMARY

- There were 40,606 motor vehicle thefts reported during 1996.
- Motor vehicle theft accounted for 13.1 percent of the total Index offenses and 14.3 percent of the property crimes.
- January recorded the highest number, with 3,861, while May recorded the lowest with 2,944.
- Autos represented the highest single category of motor vehicle theft, with 26,809, or 66.0 percent.
- The total dollar loss amounted to \$196,219,736. Of that amount, \$132,808,792 was recovered. The recovered amount reflects the value of the vehicle when recovered and may be lower than the value when stolen because of missing parts or damage.

ARRESTS/CLEARANCES

- A total of 3,197 persons were arrested in 1996.
- Adults accounted for 1,598 arrests and juveniles accounted for 1,599 arrests.
- Males accounted for 2,744 arrests, or 85.8 percent, and females accounted for 453 arrests, or 14.2 percent.
- Of those persons arrested, 83.1 percent were white, 12.1 percent were black, and 4.8 percent were other races.
- Hispanics accounted for 41.4 percent of the arrests.
- There were 4,644 clearances for motor vehicle theft reported in 1996. Juveniles represented 27.4 percent of this total.

RECOVERED MOTOR VEHICLES

- Recovered motor vehicles that were locally stolen amounted to 26,630, or a 65.6 percent recovery rate. Of those, 19,008 were recovered locally, 6,899 were recovered by another jurisdiction in-state, and 723 were recovered out of state.
- Motor vehicles that were stolen out of state and recovered by Arizona agencies amounted to 743.

MOTOR VEHICLE THEFT BY MONTH

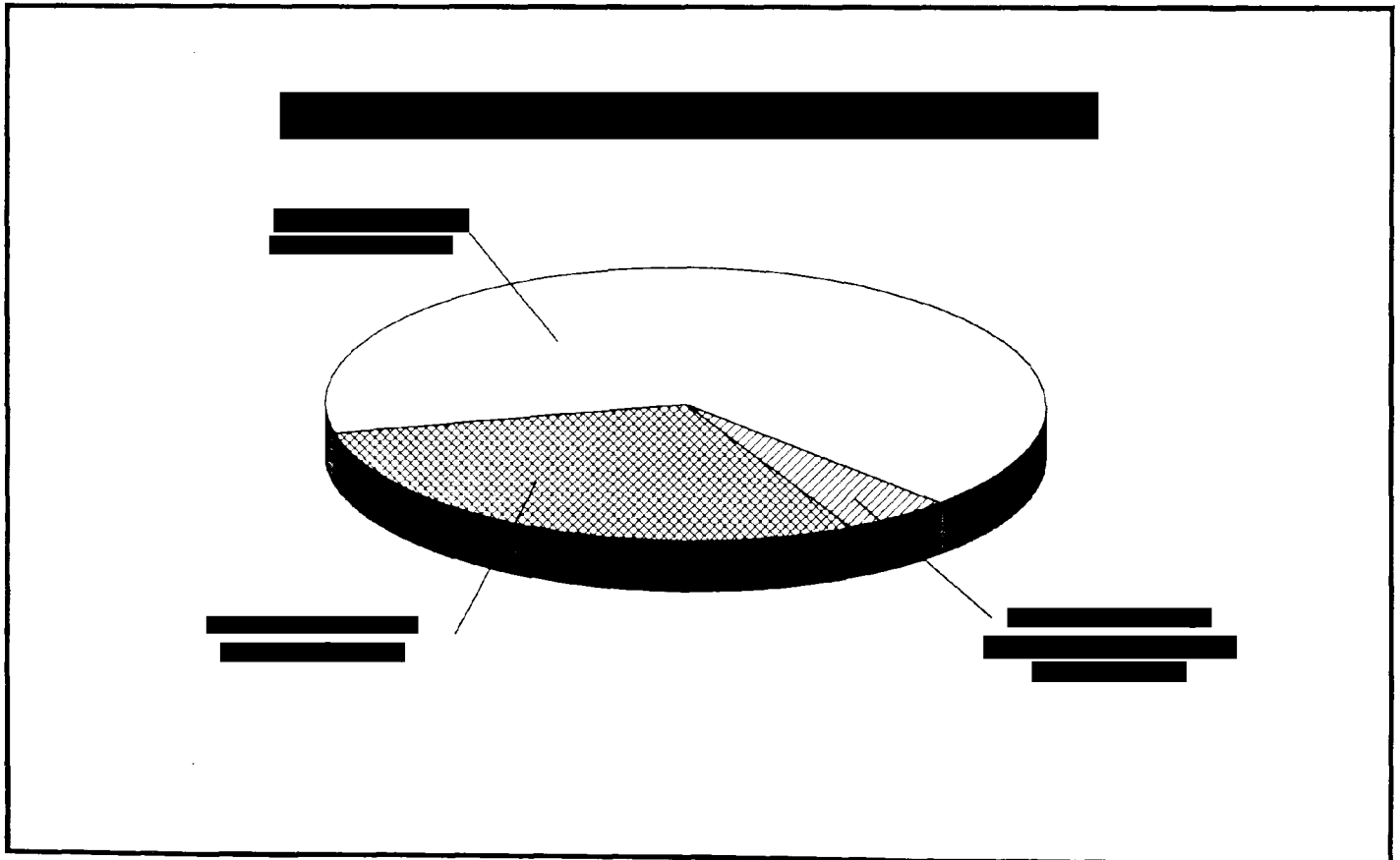
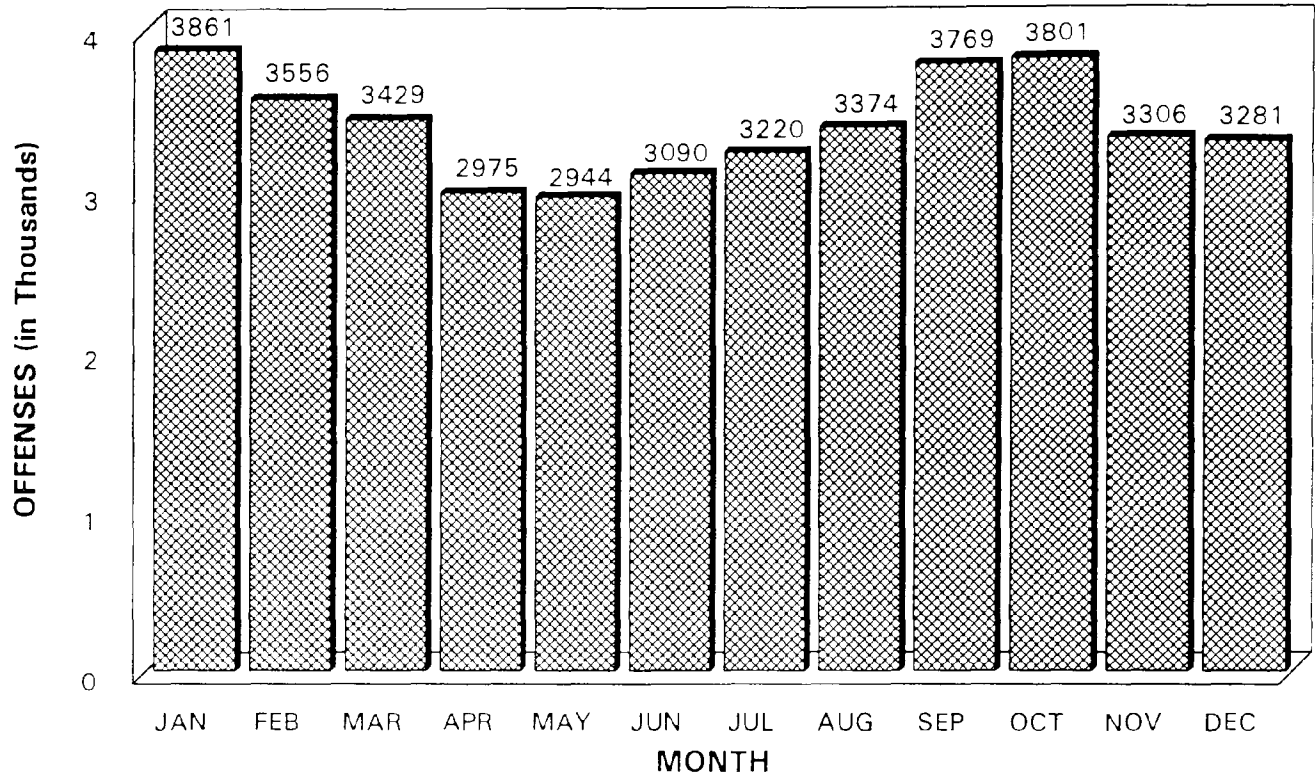

ARSON

DEFINITION

Arson is defined by the national Uniform Crime Reporting Program to include any willful or malicious burning or attempts to burn, with or without intent to defraud, a dwelling house, public building, motor vehicle or aircraft, personal property of another, etc. Fires of suspicious or unknown origins are excluded.

SUMMARY

- There were 1,373 arsons reported during 1996.
- Arson accounted for 0.4 percent of the total Index offenses and 0.5 percent of the property crimes.
- April recorded the highest number, with 155, while October recorded the lowest with 74.
- Structural arson accounted for 635 offenses or 46.2 percent.
- Motor vehicle arson accounted for the highest single known category, with 289, while industrial/manufacturing arson was the lowest with 7.
- The total estimated value of property damage amounted to \$3,921,319.
- Single residence arson had the highest dollar loss with \$1,917,830.

ARRESTS/CLEARANCES

- A total of 417 persons were arrested in 1996.
- Adults accounted for 137 arrests and juveniles accounted for 280 arrests.
- Males accounted for 376 arrests, or 90.2 percent, and females accounted for 41 arrests, or 9.8 percent.
- Of those persons arrested, 90.2 percent were white, 5.7 percent were black, and 4.1 percent were other races.
- Hispanics accounted for 16.8 percent of the arrests.
- There were 279 clearances for arson reported in 1996. Juveniles represented 54.1 percent of this total.

ARSON BY PROPERTY CLASSIFICATION

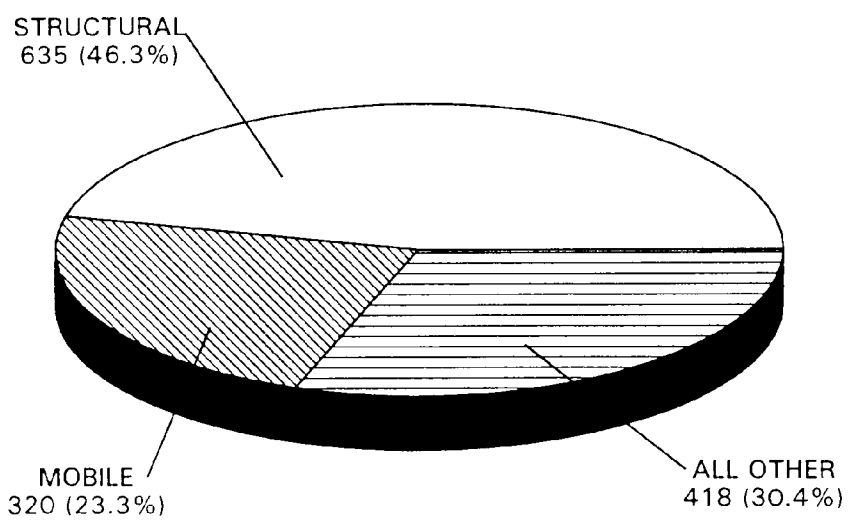

VALUE OF PROPERTY DAMAGED

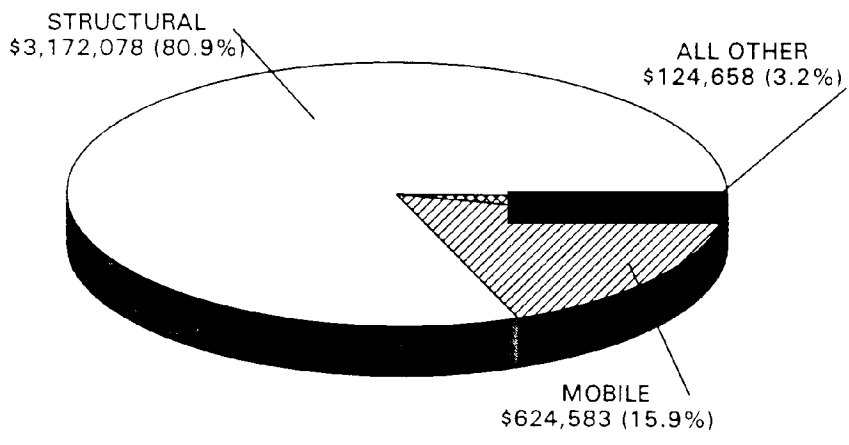

ARSON OFFENSES BY PROPERTY TYPE

PROPERTY CLASSIFICATION	TOTAL	JAN	FEB	MAR	APR	MAY	JUN	JUL	AUG	SEP	OCT	NOV	DEC	VALUE OF PROPERTY DAMAGE
STRUCTURE														
Single Occupancy Residential: Houses, Townhouses, Duplexes, Etc.	253	28	16	22	39	18	24	20	22	21	10	16	17	\$1,917,830
Other Residential: Apartments, Hotels, Motels, Dormitories, Etc.	77	10	5	3	7	8	12	5	5	8	1	7	6	244,180
Storage: Barns, Garages, Warehouses, Etc.	41	2	4	4	6	3	5	3	6	1	3	3	1	98,013
Industrial/Manufacturing	7	1	--	1	--	1	--	2	--	1	--	--	1	60,050
Other Commercial: Stores, Restaurants, Offices, Etc.	103	10	11	7	9	10	12	13	9	6	3	6	7	622,919
Community/Public: Churches, Jails, Schools, Etc.	76	11	11	7	10	11	2	7	5	6	2	1	3	30,510
All Other: Monuments, Buildings under Construction, Etc.	78	7	9	6	4	8	10	10	6	2	8	6	2	198,576
SUBTOTAL	635	69	56	50	75	59	65	60	53	45	27	39	37	\$3,172,078
MOBILE														
Motor Vehicles: Autos, Trucks, Buses, Motorcycles, Etc.	289	22	28	15	25	26	21	29	39	24	23	16	21	597,490
All Other: Trailers, Recreational Vehicles, Airplanes, Boats, Etc.	31	4	4	1	3	2	1	6	4	1	3	2	--	27,093
SUBTOTAL	320	26	32	16	28	28	22	35	43	25	26	18	21	\$624,583
ALL OTHER														
Crops, Timber, Fences, Signs, Etc.	418	34	50	39	52	65	20	29	27	18	21	28	35	124,658
TOTAL	1,373	129	138	105	155	152	107	124	123	88	74	85	93	\$3,921,319

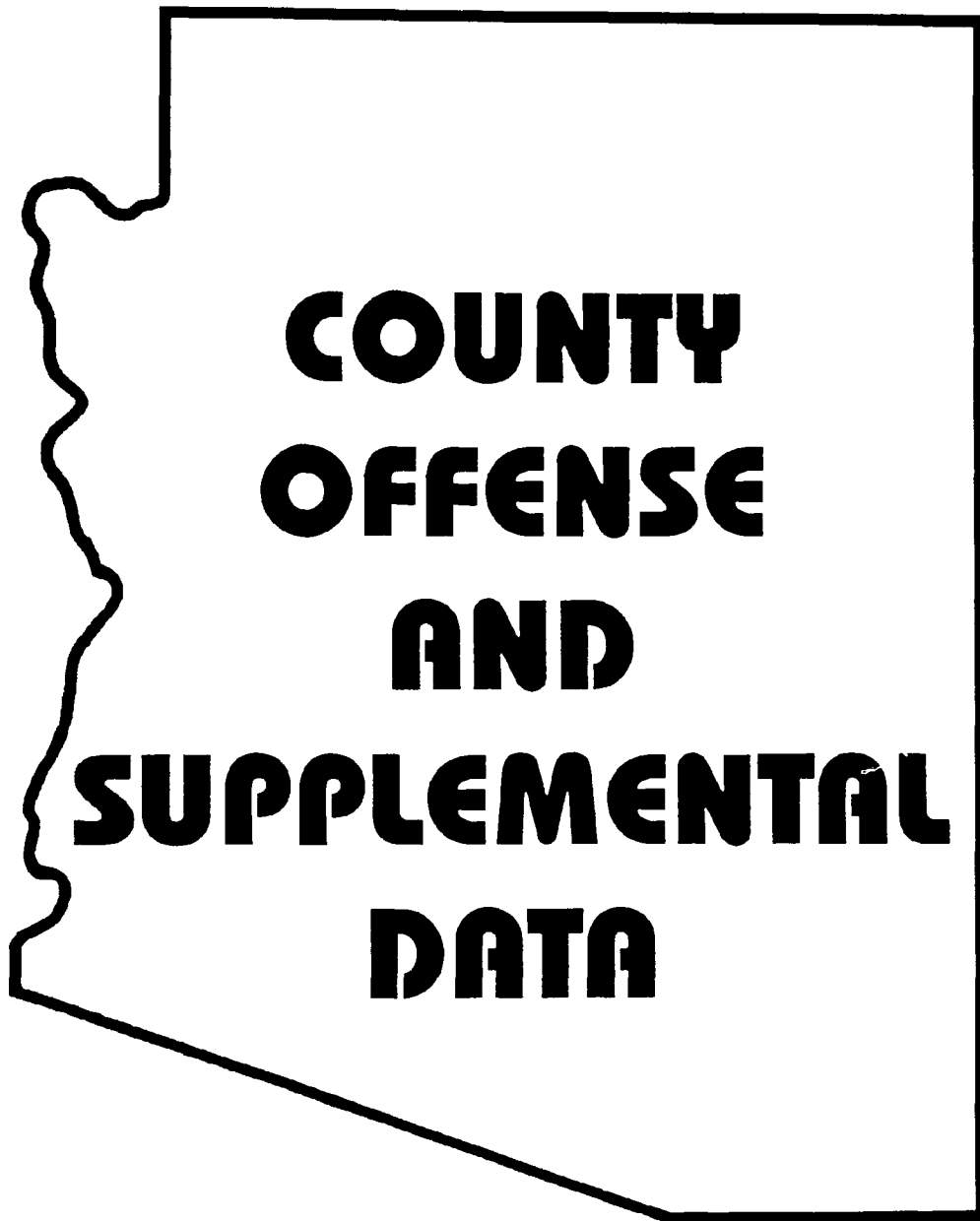

**COUNTY
OFFENSE
AND
SUPPLEMENTAL
DATA**

INDEX CRIMES BY COUNTY

INDEX CRIMES	APACHE	COCHISE	COCONINO	GILA	GRAHAM	GREENLEE
MURDER	3	2	4	--	--	--
FORCIBLE RAPE	6	7	37	10	1	--
Rape by Force	3	6	30	8	--	--
Attempts to Commit	3	1	7	2	1	--
ROBBERY	1	32	68	9	1	--
Firearm	1	13	19	--	--	--
Knife/Cutting Instrument	--	5	5	--	1	--
Other Dangerous Weapons	--	6	15	--	--	--
Strong Arm	--	8	29	9	--	--
AGGRAVATED ASSAULT	57	207	339	190	54	5
Firearm	9	26	47	20	3	--
Knife/Cutting Instrument	10	12	50	18	1	--
Other Dangerous Weapons	20	30	83	93	6	--
Physical Force	18	139	159	59	44	5
BURGLARY	151	816	1,028	386	88	--
Forcible Entry	90	484	457	179	35	--
Unlawful Entry-No Force	41	278	459	143	47	--
Attempted Forcible Entry	20	54	112	64	6	--
LARCENY-THEFT	394	2,471	5,649	1,428	618	61
MOTOR VEHICLE THEFT	32	339	221	93	22	--
Autos	19	196	140	52	8	--
Trucks and Buses	7	105	33	24	5	--
Other Vehicles	6	38	48	17	9	--
ARSON	--	12	40	10	5	--
TOTAL	644	3,886	7,386	2,126	789	66

INDEX CRIMES BY COUNTY (CONT.)

LA PAZ	MARICOPA	MOHAVE	NAVAJO	PIMA	PINAL	SANTA CRUZ	YAVAPAI	YUMA
--	259	10	2	75	9	1	5	4
--	778	17	17	377	64	3	41	25
--	661	16	16	283	53	3	36	21
--	117	1	1	94	11	--	5	4
6	5,373	73	28	1,557	89	37	28	58
4	2,323	25	7	448	14	10	10	11
--	501	9	2	166	4	8	3	8
--	386	10	1	295	11	3	6	9
2	2,163	29	18	648	60	16	9	30
40	10,760	436	268	4,396	688	182	512	375
1	4,413	60	22	1,198	179	10	53	43
--	1,692	52	26	705	86	11	39	40
6	3,041	114	48	912	241	5	365	99
33	1,614	210	172	1,581	182	156	55	193
118	36,080	2,080	595	9,277	1,895	423	1,317	993
85	20,847	679	353	6,375	1,195	372	384	636
3	13,006	1,119	206	2,045	591	25	878	279
2	2,227	82	36	857	109	26	55	78
198	116,140	4,872	2,100	38,601	5,346	618	4,387	3,022
31	29,809	523	133	7,853	629	250	286	385
16	19,335	365	82	5,502	456	144	223	271
7	9,178	85	29	2,034	82	71	34	70
8	1,296	73	22	317	91	35	29	44
1	730	71	26	376	32	8	41	21
394	199,929	8,082	3,169	62,512	8,752	1,522	6,617	4,883

ANALYSIS OF ROBBERY, BURGLARY AND LARCENY-THEFT BY COUNTY

OFFENSES	APACHE	COCHISE	COCONINO	GILA	GRAHAM	GREENLEE
ROBBERY	1	32	68	9	1	--
Highway	--	6	41	--	--	--
Commercial House	--	2	3	--	--	--
Gas or Service Station	1	--	3	--	--	--
Convenience Store	--	4	8	1	--	--
Residence	--	6	--	--	--	--
Bank	--	2	6	--	--	--
Miscellaneous	--	12	7	8	1	--
BURGLARY	151	816	1,028	386	88	--
Residence	111	574	561	239	50	--
Night (6PM-6AM)	26	120	140	77	24	--
Day (6AM-6PM)	23	268	199	124	11	--
Unknown	62	186	222	38	15	--
Non-Residence	40	242	467	147	38	--
Night (6PM-6AM)	12	110	221	31	20	--
Day (6AM-6PM)	11	49	93	86	5	--
Unknown	17	83	153	30	13	--
LARCENY-THEFT	394	2,471	5,649	1,428	618	61
\$200 and Over	120	605	1,994	442	201	39
\$50 to \$200	61	572	1,089	275	164	13
Under \$50	213	1,294	2,566	711	253	9
Pocket Picking	1	2	6	4	--	--
Purse Snatching	9	19	20	9	12	--
Shoplifting	62	556	1,097	267	188	3
From Motor Vehicle	69	214	1,141	204	81	--
Motor Vehicle Parts/Accessories	13	139	136	54	33	1
Bicycles	17	154	472	50	62	3
From Buildings	69	137	511	271	100	--
From Coin-Operated Machines	2	6	37	8	3	--
All Other	152	1,244	2,229	561	139	54
TOTAL	546	3,319	6,745	1,823	707	61

ANALYSIS OF ROBBERY, BURGLARY AND LARCENY-THEFT BY COUNTY (CONT.)

LA PAZ	MARICOPA	MOHAVE	NAVAJO	PIMA	PINAL	SANTA CRUZ	YAVAPAI	YUMA
6	5,373	73	28	1,557	89	37	28	58
2	3,035	11	11	762	31	6	7	4
--	816	3	4	170	4	--	2	--
--	72	1	3	61	1	--	--	5
1	513	6	5	250	10	4	2	13
--	483	9	1	155	9	--	2	3
--	192	5	1	56	2	--	--	1
3	262	38	3	103	32	27	15	32
118	36,080	2,080	595	9,277	1,895	423	1,317	993
55	26,454	1,373	323	6,356	1,217	292	896	669
14	4,903	231	94	1,569	443	94	172	158
19	9,825	268	59	1,315	608	147	425	206
22	11,726	874	170	3,472	166	51	299	305
63	9,626	707	272	2,921	678	131	421	324
31	3,381	259	152	816	278	40	125	92
16	1,039	93	32	417	253	59	137	43
16	5,206	355	88	1,688	147	32	159	189
198	116,140	4,872	2,100	38,601	5,346	618	4,387	3,022
85	49,793	1,714	541	9,488	1,634	255	970	1,032
37	24,222	964	438	6,257	1,175	162	612	840
76	42,125	2,194	1,121	22,856	2,537	201	2,805	1,150
--	275	4	14	84	6	5	2	6
1	363	19	14	128	15	3	5	13
31	20,248	981	554	13,083	1,104	169	747	692
32	25,127	773	210	8,077	804	138	610	489
17	25,513	172	68	3,838	376	41	230	280
18	8,841	251	129	1,925	416	16	119	331
32	7,499	336	311	4,530	455	103	414	112
--	704	38	10	201	13	1	24	26
67	27,570	2,298	790	6,735	2,157	142	2,236	1,073
322	157,593	7,025	2,723	49,435	7,330	1,078	5,732	4,073

VALUE OF PROPERTY STOLEN BY OFFENSE

OFFENSES	APACHE	COCHISE	COCONINO	GILA	GRAHAM	GREENLEE
MURDER	--	--	--	--	--	--
FORCIBLE RAPE	--	--	--	--	--	--
ROBBERY	620	48,145	37,443	7,350	25	--
Highway	--	864	4,274	--	--	--
Commercial House	--	2,201	1,897	--	--	--
Gas or Service Station	620	--	910	--	--	--
Convenience Store	--	424	5,346	155	--	--
Residence	--	4,351	--	--	--	--
Bank	--	2,590	19,566	--	--	--
Miscellaneous	--	37,715	5,450	7,195	25	--
BURGLARY	101,958	890,125	1,025,280	454,741	75,886	--
Residence	84,638	655,375	496,379	319,972	36,498	--
Night (6PM-6AM)	19,216	165,192	114,877	87,042	25,433	--
Day (6AM-6PM)	7,021	274,596	243,221	210,682	3,170	--
Unknown	58,401	215,587	138,281	22,248	7,895	--
Non-Residence	17,320	234,750	528,901	134,769	39,388	--
Night (6PM-6AM)	11,930	117,640	191,165	18,293	28,688	--
Day (6AM-6PM)	1,975	68,788	101,081	87,088	5,110	--
Unknown	3,415	48,322	236,655	29,388	5,590	--
LARCENY-THEFT	102,213	771,462	3,207,666	529,979	212,946	71,176
\$200 and Over	91,856	694,366	3,011,933	489,727	191,315	69,667
\$50-\$200	7,166	57,411	124,011	29,100	17,560	1,364
Under \$50	3,191	19,685	71,722	11,152	4,071	145
Pocket Picking	6	103	3,620	607	--	--
Purse Snatching	2,226	1,634	20,171	430	2,895	--
Shoplifting	2,301	20,310	87,460	5,981	4,124	35
From Motor Vehicle	35,000	70,587	520,274	91,340	40,790	--
Motor Vehicle Parts/Accessories	2,161	21,641	20,424	109,697	7,977	450
Bicycles	3,038	26,161	188,048	13,486	10,487	4,810
From Buildings	21,852	91,669	269,681	122,247	56,752	--
From Coin-Operated Machines	39	1,235	3,940	391	215	--
All Other	35,590	538,122	2,094,048	185,800	89,706	65,881
MOTOR VEHICLE THEFT	159,127	1,863,817	1,601,957	428,981	86,378	--
TOTAL	363,918	3,573,549	5,872,346	1,421,051	375,235	71,176

VALUE OF PROPERTY STOLEN BY OFFENSE (CONT.)

LA PAZ	MARICOPA	MOHAVE	NAVAJO	PIMA	PINAL	SANTA CRUZ	YAVAPAI	YUMA
--	46,313	--	567	--	--	--	--	--
--	83,090	--	--	1,220	--	--	1,000	310
4,460	6,127,485	69,161	4,473	699,544	155,398	5,545	5,578	27,260
600	3,272,768	860	1,399	381,209	21,756	170	3,552	211
--	874,952	22	183	125,497	887	--	118	--
--	56,546	--	2,001	4,281	60,000	--	--	3,237
2,630	122,361	90	542	24,161	365	120	216	2,393
--	633,686	31,405	3	64,198	2,638	--	637	994
--	1,031,938	7,402	160	28,832	4,289	--	--	--
1,230	135,234	29,382	185	71,366	65,463	5,255	1,055	20,425
82,883	58,264,412	2,524,973	605,364	11,168,441	2,479,417	351,944	1,080,338	994,839
47,581	41,849,600	1,852,125	368,123	8,229,261	1,705,111	255,995	697,924	641,500
10,637	5,850,953	189,854	139,639	1,463,069	477,247	78,683	76,899	154,617
20,871	16,432,927	315,184	44,052	1,377,982	1,095,537	145,276	296,830	145,918
16,073	19,565,720	1,347,087	184,432	5,388,210	132,327	32,036	324,195	340,965
35,302	16,414,812	672,848	237,241	2,939,180	774,306	95,949	382,414	353,339
17,659	4,227,135	202,416	139,164	680,428	179,950	36,036	158,001	74,886
13,980	909,221	68,659	5,138	278,996	416,607	43,285	93,808	45,460
3,663	11,278,456	401,773	92,939	1,979,756	177,749	16,628	130,605	232,993
92,220	60,895,604	2,222,884	673,821	9,435,506	1,795,722	358,992	1,028,729	1,010,365
86,702	56,840,508	2,081,159	610,094	8,571,182	1,619,166	337,616	942,113	907,052
4,684	2,809,206	102,856	48,696	786,595	132,649	16,806	64,021	88,155
834	1,245,890	38,869	15,031	77,729	43,907	4,570	22,595	15,158
--	77,949	1,288	3,507	26,496	664	350	267	1,115
500	99,837	3,675	2,937	19,265	4,371	355	21,703	1,937
2,249	1,604,158	37,747	11,789	385,103	32,265	11,340	20,184	35,649
16,779	13,738,136	355,798	93,812	3,027,206	303,423	65,438	290,089	166,472
4,479	11,075,754	56,646	21,431	821,079	144,657	59,493	89,412	75,619
5,262	2,769,915	65,758	24,601	647,610	81,119	3,449	32,645	69,230
33,281	6,324,008	217,299	203,661	2,207,111	218,072	45,636	240,898	48,933
--	147,235	1,385	351	31,778	5,247	400	2,213	1,704
29,670	25,058,612	1,483,288	311,732	2,269,858	1,005,904	172,531	331,318	609,706
123,750	156,761,640	2,203,107	867,382	23,518,091	3,040,218	1,574,680	947,371	2,483,719
303,313	282,178,544	7,020,125	2,151,607	44,822,802	7,470,755	2,291,161	3,063,016	4,516,493

TYPE AND VALUE, IN DOLLARS, OF PROPERTY STOLEN AND RECOVERED

STOLEN	APACHE	COCHISE	COCONINO	GILA	GRAHAM	GREENLEE
Currency/Notes/Etc.	21,390	246,701	1,502,337	111,538	15,460	6,554
Jewelry/Precious Metals	14,031	235,084	282,254	132,131	20,638	5,836
Clothing and Furs	6,386	35,509	138,786	9,475	1,131	--
Locally Stolen Vehicles	150,820	1,919,526	1,603,219	428,126	88,353	--
Office Equipment	4,674	70,227	141,913	29,614	1,300	11,700
Stereos/TV's/Cameras	38,766	241,172	533,555	109,158	48,094	7,206
Firearms	8,974	70,536	64,253	47,273	12,675	500
Household Goods	20,390	53,343	108,087	47,083	10,537	--
Consumable Goods	4,146	24,352	40,074	8,339	4,797	9
Livestock	150	2,208	450	--	2,650	--
Miscellaneous	94,191	674,891	1,457,418	498,314	169,600	39,371
TOTAL STOLEN	363,918	3,573,549	5,872,346	1,421,051	375,235	71,176
RECOVERED						
Currency/Notes/Etc.	9,663	9,147	1,111,229	5,687	2,199	340
Jewelry/Precious Metals	1,350	19,333	27,367	20,081	6,653	--
Clothing and Furs	819	4,935	24,649	2,038	412	--
Locally Stolen Vehicles	125,920	995,158	1,130,743	359,448	59,970	--
Office Equipment	40	9,052	124,343	1,038	25	--
Stereos/TV's/Cameras	5,806	21,968	113,857	9,884	6,714	3,556
Firearms	2,980	11,960	20,558	8,505	1,775	--
Household Goods	3,946	2,902	30,699	2,151	4,489	--
Consumable Goods	750	3,125	5,286	1,945	1,970	4
Livestock	--	8	--	--	500	--
Miscellaneous	10,791	47,643	125,831	123,173	105,380	10,701
TOTAL RECOVERED	162,065	1,125,231	2,714,562	533,950	190,087	14,601

TYPE AND VALUE, IN DOLLARS, OF PROPERTY STOLEN AND RECOVERED (CONT.)

LA PAZ	MARICOPA	MOHAVE	NAVAJO	PIMA	PINAL	SANTA CRUZ	YAVAPAI	YUMA
42,244	8,252,053	462,607	174,955	1,280,186	456,826	30,392	332,570	264,970
18,616	19,166,309	703,079	135,001	4,498,956	379,639	98,330	272,236	275,607
2,501	3,174,082	79,618	21,408	834,002	98,885	21,454	44,161	68,004
120,982	157,931,404	2,311,875	874,867	23,470,441	2,613,888	1,570,598	977,023	2,158,614
4,000	13,093,215	87,405	23,333	1,976,683	87,970	46,099	37,881	43,360
37,041	23,074,068	599,163	145,262	4,716,460	1,076,518	117,839	373,312	314,603
4,807	2,579,576	142,160	71,930	562,159	168,957	11,072	88,150	49,583
17,462	4,939,906	247,399	74,408	973,052	145,737	17,749	79,101	137,388
1,474	927,534	53,515	27,063	83,406	68,326	7,706	22,508	21,661
285	16,444	2,730	--	51,686	8,240	11,500	40	1,050
53,901	49,023,953	2,330,574	603,380	6,375,771	2,365,769	358,422	836,034	1,181,653
303,313	282,178,544	7,020,125	2,151,607	44,822,802	7,470,755	2,291,161	3,063,016	4,516,493
709	358,570	74,979	21,222	22,206	9,689	2,555	30,346	2,626
600	693,014	50,111	14,172	44,785	27,033	990	27,383	21,090
40	441,853	9,506	1,638	98,874	5,515	3,925	8,784	18,109
64,980	113,320,316	1,682,048	590,410	10,756,972	1,878,927	320,822	671,783	851,295
1,100	539,773	6,519	1,030	44,675	19,794	--	2,571	3,359
1,882	749,980	48,877	9,540	96,426	38,300	1,533	42,278	19,759
787	260,892	23,018	9,626	54,549	9,734	850	9,765	2,199
516	158,472	10,119	993	15,041	2,781	124	767	2,277
33	219,367	8,205	3,134	12,968	7,711	1,249	11,722	5,864
--	2,440	150	190	3,380	720	--	--	750
1,340	4,398,935	398,907	52,280	353,767	417,861	6,283	85,957	226,982
71,987	121,143,612	2,312,439	704,235	11,503,643	2,418,065	338,331	891,356	1,154,310



ARREST SUMMARY

- There were 315,134 arrests reported in 1996.
- Arrests for Part I offenses amounted to 60,336, or 19.1 percent.
- Arrests for Part II offenses amounted to 254,798, or 80.9 percent.
- Adult arrests were 242,088, or 76.8 percent, and juvenile arrests were 73,046, or 23.2 percent.
- Males accounted for 247,833 arrests, or 78.6 percent, and females accounted for 67,301, or 21.4 percent.
- Arrests for adults between the ages of 25-29 recorded the highest number with 41,632, or 17.2 percent of the total adult arrests.
- Arrests for juveniles age 12 and under were 7,019, or 9.6 percent of the total juvenile arrests.
- Of those persons arrested, 83.9 percent were white, 8.7 percent were black, and 7.4 percent were other races.
- Hispanics accounted for 28.8 percent of the arrests.
- Larceny-theft recorded the highest number of arrests of a specific offense with 40,785, or 12.9 of the total.

ARREST BY AGE GROUP

OFFENSE	ADULT ARRESTS		JUVENILE ARRESTS	
	MALE	FEMALE	MALE	FEMALE
Homicide	187	27	41	5
Forcible Rape	226	2	37	1
Robbery	1,077	96	441	45
Aggravated Assault	4,875	863	1,395	274
Burglary	3,052	331	2,719	243
Larceny-Theft	20,327	7,914	8,473	4,071
Motor Vehicle Theft	1,398	200	1,346	253
Arson	122	15	254	26
TOTAL	31,264	9,448	14,706	4,918

TOTAL ARRESTS BY OFFENSE, RACE & ETHNIC ORIGIN

OFFENSE CLASSIFICATION	NUMBER of ARRESTS	DIST.	WHITE	BLACK	INDIAN	ASIAN	HISPANIC	NON HISPANIC
PART I								
Murder/Nonneg. Manslaughter	260	0.08%	210	35	13	2	93	167
Forcible Rape	266	0.08%	199	57	9	1	93	173
Robbery	1,659	0.54%	1,150	444	58	7	591	1,068
Aggravated Assault	7,407	2.35%	6,088	842	431	46	2,323	5,084
Burglary	6,345	2.01%	5,463	626	216	40	2,086	4,259
Larceny-Theft	40,785	12.94%	33,780	4,249	2,467	289	11,778	29,007
Motor Vehicle Theft	3,197	1.02%	2,656	388	141	12	1,322	1,875
Arson	417	0.13%	376	24	12	5	70	347
PART I SUBTOTAL	60,336	19.15%	49,922	6,665	3,347	402	18,356	41,980
PART II								
Manslaughter by Negligence	37	0.01%	31	3	3	--	8	29
Other Assaults - Simple	30,255	9.60%	24,831	3,209	2,046	169	9,076	21,179
Forgery and Counterfeiting	1,618	0.51%	1,386	187	31	14	436	1,182
Fraud	1,879	0.60%	1,571	255	42	11	265	1,614
Embezzlement	211	0.07%	181	26	4	--	42	169
Stolen Property	3,033	0.96%	2,531	410	64	28	1,102	1,931
Vandalism	10,318	3.27%	8,827	851	577	63	3,016	7,302
Weapons: Carrying, Possessing, Etc.	4,112	1.31%	3,421	604	72	15	1,777	2,335
Prostitution and Comm. Vice	2,466	0.78%	1,885	481	74	26	455	2,011
Sex Offenses	2,334	0.74%	1,913	221	184	16	532	1,802
DRUGS, SALE OR MFG.								
Opium, Cocaine, Derivatives	1,606	0.51%	1,312	274	17	3	836	770
Marijuana	1,343	0.43%	1,204	82	53	4	485	858
Synthetic Narcotics	596	0.19%	512	75	8	1	137	459
Other Dangerous Nonnarcotics	1,320	0.42%	1,257	46	16	1	211	1,109
DRUGS, POSSESSION								
Opium, Cocaine, Derivatives	2,752	0.87%	2,199	486	61	6	1,119	1,633
Marijuana	12,939	4.11%	11,372	1,013	505	49	3,816	9,123
Synthetic Narcotics	1,803	0.57%	1,635	138	25	5	473	1,330
Other Dangerous Nonnarcotics	2,965	0.94%	2,567	314	75	9	761	2,204
All Gambling	39	0.01%	31	7	--	1	7	32
Offenses Against Family/Children	2,406	0.76%	2,048	141	201	16	492	1,914
Driving Under the Influence	33,633	10.67%	29,814	903	2,791	125	10,106	23,527
Liquor Law Violations	26,714	8.48%	22,834	1,286	2,480	114	7,331	19,383
Disorderly Conduct	23,517	7.46%	19,378	1,947	2,077	115	6,099	17,418
Vagrancy	829	0.26%	581	72	174	2	184	645
All Other, Except Traffic	68,477	21.73%	55,166	6,599	6,493	219	17,276	51,201
Curfew/Loitering (Juveniles)	9,357	2.97%	8,450	629	217	61	4,199	5,158
Runaways (Juveniles)	8,239	2.62%	7,455	545	173	66	2,114	6,125
PART II SUBTOTAL	254,798	80.85%	214,392	20,804	18,463	1,139	72,355	182,443
TOTAL	315,134	100.00%	264,314	27,469	21,810	1,541	90,711	224,423

JUVENILE ARRESTS BY OFFENSE, RACE & ETHNIC ORIGIN

OFFENSE CLASSIFICATION	NUMBER of ARRESTS	DIST.	WHITE	BLACK	INDIAN	ASIAN	HISPANIC	NON HISPANIC
PART I								
Murder/Nonneg. Manslaughter	46	0.06%	35	8	3	--	16	30
Forcible Rape	38	0.05%	30	7	1	--	14	24
Robbery	486	0.67%	343	128	11	4	196	290
Aggravated Assault	1,669	2.29%	1,399	196	64	10	596	1,073
Burglary	2,962	4.05%	2,653	198	96	15	1,042	1,920
Larceny-Theft	12,544	17.17%	10,658	1,096	693	97	3,624	8,920
Motor Vehicle Theft	1,599	2.19%	1,350	160	82	7	714	885
Arson	280	0.38%	254	18	5	3	50	230
PART I SUBTOTAL	19,624	26.86%	16,722	1,811	955	136	6,252	13,372
PART II								
Manslaughter by Negligence	2	0.01%	2	--	--	--	1	1
Other Assaults - Simple	5,346	7.32%	4,591	552	182	21	1,729	3,617
Forgery and Counterfeiting	138	0.19%	112	18	5	3	32	106
Fraud	117	0.16%	95	22	--	--	23	94
Embezzlement	27	0.04%	24	3	--	--	9	18
Stolen Property	812	1.11%	684	100	23	5	368	444
Vandalism	3,836	5.25%	3,422	234	157	23	1,307	2,529
Weapons: Carrying, Possessing, Etc.	904	1.24%	769	109	23	3	444	460
Prostitution and Comm. Vice	42	0.06%	30	9	2	1	8	34
Sex Offenses	355	0.49%	306	37	10	2	102	253
DRUGS, SALE OR MFG.								
Opium, Cocaine, Derivatives	176	0.24%	157	14	4	1	61	115
Marijuana	314	0.43%	270	18	25	1	109	205
Synthetic Narcotics	68	0.09%	59	9	--	--	16	52
Other Dangerous Nonnarcotics	52	0.07%	46	4	2	--	14	38
DRUGS, POSSESSION								
Opium, Cocaine, Derivatives	188	0.26%	152	28	7	1	75	113
Marijuana	3,715	5.09%	3,325	212	151	27	1,286	2,429
Synthetic Narcotics	166	0.23%	153	5	8	--	58	108
Other Dangerous Nonnarcotics	756	1.03%	719	24	13	--	299	457
All Gambling	7	0.01%	7	--	--	--	1	6
Offenses Against Family/Children	201	0.27%	175	19	4	3	42	159
Driving Under the Influence	462	0.63%	408	12	40	2	153	309
Liquor Law Violations	6,598	9.03%	5,919	185	469	25	1,901	4,697
Disorderly Conduct	4,384	6.00%	3,848	362	161	13	1,589	2,795
Vagrancy	66	0.09%	57	5	4	--	20	46
All Other, Except Traffic	7,094	9.71%	6,430	431	217	16	1,960	5,134
Curfew/Loitering (Juveniles)	9,357	12.81%	8,450	629	217	61	4,199	5,158
Runaways (Juveniles)	8,239	11.28%	7,455	545	173	66	2,114	6,125
PART II SUBTOTAL	53,422	73.14%	47,665	3,586	1,897	274	17,920	35,502
TOTAL	73,046	100.00%	64,387	5,397	2,852	410	24,172	48,874

ADULT ARRESTS BY OFFENSE, RACE & ETHNIC ORIGIN

OFFENSE CLASSIFICATION	NUMBER of ARRESTS	DIST.	WHITE	BLACK	INDIAN	ASIAN	HISPANIC	NON HISPANIC
PART I								
Murder/Nonneg. Manslaughter	214	0.09%	175	27	10	2	77	137
Forcible Rape	228	0.09%	169	50	8	1	79	149
Robbery	1,173	0.48%	807	316	47	3	395	778
Aggravated Assault	5,738	2.37%	4,689	646	367	36	1,727	4,011
Burglary	3,383	1.40%	2,810	428	120	25	1,044	2,339
Larceny-Theft	28,241	11.67%	23,122	3,153	1,774	192	8,154	20,087
Motor Vehicle Theft	1,598	0.66%	1,306	228	59	5	608	990
Arson	137	0.06%	122	6	7	2	20	117
PART I SUBTOTAL	40,712	16.82%	33,200	4,854	2,392	266	12,104	28,608
PART II								
Manslaughter by Negligence	35	0.01%	29	3	3	--	7	28
Other Assaults - Simple	24,909	10.29%	20,240	2,657	1,864	148	7,347	17,562
Forgery and Counterfeiting	1,480	0.61%	1,274	169	26	11	404	1,076
Fraud	1,762	0.73%	1,476	233	42	11	242	1,520
Embezzlement	184	0.08%	157	23	4	--	33	151
Stolen Property	2,221	0.92%	1,847	310	41	23	734	1,487
Vandalism	6,482	2.68%	5,405	617	420	40	1,709	4,773
Weapons: Carrying, Possessing, Etc.	3,208	1.33%	2,652	495	49	12	1,333	1,875
Prostitution and Comm. Vice	2,424	1.00%	1,855	472	72	25	417	1,977
Sex Offenses	1,979	0.82%	1,607	184	174	14	430	1,549
DRUGS, SALE OR MFG.								
Opium, Cocaine, Derivatives	1,430	0.59%	1,155	260	13	2	775	655
Marijuana	1,029	0.42%	934	64	28	3	376	653
Synthetic Narcotics	528	0.22%	453	66	8	1	121	407
Other Dangerous Nonnarcotics	1,268	0.52%	1,211	42	14	1	197	1,071
DRUGS, POSSESSION								
Opium, Cocaine, Derivatives	2,564	1.06%	2,047	458	54	5	1,044	1,520
Marijuana	9,224	3.81%	8,047	801	354	22	2,530	6,694
Synthetic Narcotics	1,637	0.68%	1,482	133	17	5	415	1,222
Other Dangerous Nonnarcotics	2,209	0.91%	1,848	290	62	9	462	1,747
All Gambling	32	0.01%	24	7	--	1	6	26
Offenses Against Family/Children	2,205	0.91%	1,873	122	197	13	450	1,755
Driving Under the Influence	33,171	13.70%	29,406	891	2,751	123	9,953	23,218
Liquor Law Violations	20,116	8.31%	16,915	1,101	2,011	89	5,430	14,686
Disorderly Conduct	19,133	7.90%	15,530	1,585	1,916	102	4,510	14,623
Vagrancy	763	0.31%	524	67	170	2	164	599
All Other, Except Traffic	61,383	25.36%	48,736	6,168	6,276	203	15,316	46,067
Curfew/Loitering (Juveniles)	--	--	--	--	--	--	--	--
Runaways (Juveniles)	--	--	--	--	--	--	--	--
PART II SUBTOTAL	201,376	83.18%	166,727	17,218	16,566	865	54,435	146,941
TOTAL	242,088	100.00%	199,927	22,072	18,958	1,131	66,539	175,549

TOTAL ARRESTS BY AGE

OFFENSE CLASSIFICATION	UNDER 10	10-12	13-14	15	16	17	TOTAL UNDER 18	18	19	20	21
PART I											
Murder/Nonneg. Manslaughter	--	1	7	7	13	18	46	10	20	10	14
Forcible Rape	--	2	10	6	10	10	38	14	12	2	10
Robbery	2	23	97	79	133	152	486	151	93	90	89
Aggravated Assault	41	172	426	280	373	377	1,669	314	303	238	252
Burglary	85	391	824	622	556	484	2,962	422	287	220	171
Larceny-Theft	218	1,600	3,768	2,407	2,341	2,210	12,544	2,014	1,615	1,295	1,157
Motor Vehicle Theft	7	72	416	384	412	308	1,599	215	143	103	86
Arson	39	88	92	30	16	15	280	11	11	2	10
PART I SUBTOTAL	392	2,349	5,640	3,815	3,854	3,574	19,624	3,151	2,484	1,960	1,789
PART II											
Manslaughter by Negligence	--	--	--	--	2	--	2	--	8	1	1
Other Assaults - Simple	104	686	1,624	1,029	1,056	847	5,346	760	819	763	910
Forgery and Counterfeiting	--	5	10	26	42	55	138	80	73	81	65
Fraud	--	9	10	20	37	41	117	80	73	72	61
Embezzlement	--	1	--	3	11	12	27	11	8	6	18
Stolen Property	4	22	150	202	213	221	812	210	148	119	96
Vandalism	162	543	1,134	696	720	581	3,836	473	305	296	296
Weapons: Carrying, Possessing, Etc.	7	44	170	156	237	290	904	315	272	233	245
Prostitution and Comm. Vice	--	--	3	9	11	19	42	71	96	91	96
Sex Offenses	14	48	133	56	60	44	355	39	64	49	70
DRUGS, SALE OR MFG.											
Opium, Cocaine, Derivatives	--	5	32	31	52	56	176	69	90	91	83
Marijuana	2	20	79	55	70	88	314	83	72	61	55
Synthetic Narcotics	--	3	22	13	12	18	68	22	16	28	15
Other Dangerous Nonnarcotics	--	4	8	9	15	16	52	32	28	33	25
DRUGS, POSSESSION											
Opium, Cocaine, Derivatives	1	2	38	32	56	59	188	104	108	94	100
Marijuana	9	163	810	819	938	976	3,715	1,056	942	726	575
Synthetic Narcotics	1	4	40	34	46	41	166	73	57	52	42
Other Dangerous Nonnarcotics	2	43	193	168	192	158	756	159	118	111	87
All Gambling	--	1	--	--	4	2	7	1	--	1	1
Offenses Against Family/Children	2	7	54	37	54	47	201	88	79	85	74
Driving Under the Influence	11	2	11	25	132	281	462	590	813	911	1,283
Liquor Law Violations	13	66	732	1,062	2,027	2,698	6,598	3,858	3,497	2,718	649
Disorderly Conduct	95	424	1,211	885	922	847	4,384	883	763	762	890
Vagrancy	--	2	20	17	12	15	66	58	43	38	29
All Other, Except Traffic	107	497	1,746	1,500	1,702	1,542	7,094	2,470	2,738	2,673	2,711
Curfew/Loitering (Juvenile)	61	454	2,460	2,279	2,231	1,872	9,357	--	--	--	--
Runaways (Juvenile)	55	573	2,660	2,061	1,923	967	8,239	--	--	--	--
PART II SUBTOTAL	650	3,628	13,350	11,224	12,777	11,793	53,422	11,585	11,230	10,095	8,477
TOTAL	1,042	5,977	18,990	15,039	16,631	15,367	73,046	14,736	13,714	12,055	10,266

TOTAL ARRESTS BY AGE (CONT.)

22	23	24	25-29	30-34	35-39	40-44	45-49	50-54	55-59	60-64	65 AND OVER	TOTAL OVER 18	TOTAL ALL AGES
16	8	15	40	24	19	16	5	6	3	2	6	214	260
10	12	7	47	36	38	16	12	6	1	4	1	228	266
45	65	37	205	175	113	61	35	7	6	1	--	1,173	1,659
241	219	226	985	932	824	563	323	154	64	46	54	5,738	7,407
135	125	110	597	476	433	250	93	34	16	7	7	3,383	6,345
925	922	914	4,336	4,577	4,174	2,898	1,552	750	370	251	491	28,241	40,785
70	64	55	291	241	187	90	34	11	3	1	4	1,598	3,197
5	5	4	17	21	15	15	7	7	4	2	1	137	417
1,447	1,420	1,368	6,518	6,482	5,803	3,909	2,061	975	467	314	564	40,712	60,336
3	3	1	4	7	1	3	2	--	--	--	1	35	37
1,022	990	933	5,022	4,897	4,001	2,422	1,263	527	248	144	188	24,909	30,255
65	75	68	284	296	196	127	50	9	8	2	1	1,480	1,618
71	44	62	280	348	286	173	112	53	19	15	13	1,762	1,879
12	7	6	44	26	23	9	8	4	1	1	--	184	211
97	103	96	458	389	252	149	45	35	13	5	6	2,221	3,033
266	251	249	1,196	1,193	863	529	293	130	69	30	43	6,482	10,318
197	175	144	541	409	299	192	86	49	29	6	16	3,208	4,112
99	80	105	506	475	411	213	72	38	24	17	30	2,424	2,466
59	50	53	299	355	313	213	163	107	49	44	52	1,979	2,334
82	75	53	286	240	164	118	49	17	8	3	2	1,430	1,606
46	35	49	199	146	116	96	39	20	7	3	2	1,029	1,343
21	14	22	112	91	90	55	25	13	4	--	--	528	596
34	42	46	295	297	236	129	48	15	3	1	4	1,268	1,320
88	87	98	466	510	437	267	139	42	22	2	--	2,564	2,752
465	414	389	1,560	1,152	957	564	258	101	40	13	12	9,224	12,939
52	49	52	355	332	317	166	70	11	4	5	--	1,637	1,803
79	58	58	380	459	343	235	87	22	3	3	7	2,209	2,965
3	--	--	3	3	3	8	2	3	2	1	1	32	39
74	60	87	391	475	374	213	107	55	24	10	9	2,205	2,406
1,300	1,444	1,325	6,175	5,676	4,917	3,539	2,325	1,327	757	402	387	33,171	33,633
433	403	324	1,485	1,491	1,596	1,448	930	508	368	191	217	20,116	26,714
827	733	697	3,233	3,115	2,992	1,908	1,143	543	283	166	195	19,133	23,517
31	19	15	90	103	123	100	56	21	14	14	9	763	829
2,454	2,518	2,341	11,450	10,902	9,150	5,765	3,212	1,379	718	422	480	61,383	68,477
--	--	--	--	--	--	--	--	--	--	--	--	--	9,357
--	--	--	--	--	--	--	--	--	--	--	--	--	8,239
7,880	7,729	7,273	35,114	33,387	28,460	18,641	10,584	5,029	2,717	1,500	1,675	201,376	254,798
9,327	9,149	8,641	41,632	39,869	34,263	22,550	12,645	6,004	3,184	1,814	2,239	242,088	315,134

JUVENILE MALE ARRESTS

OFFENSE CLASSIFICATION	AGE						TOTAL ARRESTS
	UNDER 10	10-12	13-14	15	16	17	
PART I							
Murder/Nonneg. Manslaughter	--	1	6	5	12	17	41
Forcible Rape	--	2	10	6	10	9	37
Robbery	2	21	83	73	121	141	441
Aggravated Assault	35	152	324	232	318	334	1,395
Burglary	74	336	758	577	515	459	2,719
Larceny-Theft	169	1,062	2,454	1,592	1,640	1,556	8,473
Motor Vehicle Theft	5	54	341	311	359	276	1,346
Arson	39	80	80	26	14	15	254
PART I SUBTOTAL	324	1,708	4,056	2,822	2,989	2,807	14,706
PART II							
Manslaughter by Negligence	--	--	--	--	2	--	2
Other Assaults - Simple	89	527	1,047	687	746	593	3,689
Forgery and Counterfeiting	--	2	6	19	30	32	89
Fraud	--	7	7	12	23	22	71
Embezzlement	--	1	--	3	7	10	21
Stolen Property	4	21	121	177	195	200	718
Vandalism	154	482	952	590	624	517	3,319
Weapons: Carrying, Possessing, Etc.	5	40	150	146	230	279	850
Prostitution and Comm. Vice	--	--	1	--	2	4	7
Sex Offenses	13	47	130	55	56	42	343
DRUGS, SALE OR MFG.							
Opium, Cocaine, Derivatives	--	4	27	25	38	47	141
Marijuana	2	18	62	45	62	76	265
Synthetic Narcotics	--	2	19	12	11	16	60
Other Dangerous Nonnarcotics	--	3	6	6	10	13	38
DRUGS, POSSESSION							
Opium, Cocaine, Derivatives	1	--	23	24	49	52	149
Marijuana	7	122	600	667	786	835	3,017
Synthetic Narcotics	--	3	25	30	38	34	130
Other Dangerous Nonnarcotics	2	31	125	124	153	131	566
All Gambling	--	1	--	--	2	2	5
Offenses Against Family/Children	1	5	32	25	36	36	135
Driving Under the Influence	9	1	9	17	107	245	388
Liquor Law Violations	8	41	445	735	1,470	2,082	4,781
Disorderly Conduct	83	305	808	625	681	661	3,163
Vagrancy	--	--	14	15	8	13	50
All Other, Except Traffic	88	392	1,272	1,101	1,298	1,244	5,395
Curfew/Loitering	48	305	1,488	1,432	1,524	1,396	6,193
Runaways	44	331	1,030	806	956	502	3,669
PART II SUBTOTAL	558	2,691	8,399	7,378	9,144	9,084	37,254
TOTAL	882	4,399	12,455	10,200	12,133	11,891	51,960

JUVENILE FEMALE ARRESTS

OFFENSE CLASSIFICATION	AGE						TOTAL ARRESTS
	UNDER 10	10-12	13-14	15	16	17	
PART I							
Murder/Nonneg. Manslaughter	--	--	1	2	1	1	5
Forcible Rape	--	--	--	--	--	1	1
Robbery	--	2	14	6	12	11	45
Aggravated Assault	6	20	102	48	55	43	274
Burglary	11	55	66	45	41	25	243
Larceny-Theft	49	538	1,314	815	701	654	4,071
Motor Vehicle Theft	2	18	75	73	53	32	253
Arson	--	8	12	4	2	--	26
PART I SUBTOTAL	68	641	1,584	993	865	767	4,918
PART II							
Manslaughter by Negligence	--	--	--	--	--	--	--
Other Assaults - Simple	15	159	577	342	310	254	1,657
Forgery and Counterfeiting	--	3	4	7	12	23	49
Fraud	--	2	3	8	14	19	46
Embezzlement	--	--	--	--	4	2	6
Stolen Property	--	1	29	25	18	21	94
Vandalism	8	61	182	106	96	64	517
Weapons: Carrying, Possessing, Etc.	2	4	20	10	7	11	54
Prostitution and Comm. Vice	--	--	2	9	9	15	35
Sex Offenses	1	1	3	1	4	2	12
DRUGS, SALE OR MFG.							
Opium, Cocaine, Derivatives	--	1	5	6	14	9	35
Marijuana	--	2	17	10	8	12	49
Synthetic Narcotics	--	1	3	1	1	2	8
Other Dangerous Nonnarcotics	--	1	2	3	5	3	14
DRUGS, POSSESSION							
Opium, Cocaine, Derivatives	--	2	15	8	7	7	39
Marijuana	2	41	210	152	152	141	698
Synthetic Narcotics	1	1	15	4	8	7	36
Other Dangerous Nonnarcotics	--	12	68	44	39	27	190
All Gambling	--	--	--	--	2	--	2
Offenses Against Family/Children	1	2	22	12	18	11	66
Driving Under the Influence	2	1	2	8	25	36	74
Liquor Law Violations	5	25	287	327	557	616	1,817
Disorderly Conduct	12	119	403	260	241	186	1,221
Vagrancy	--	2	6	2	4	2	16
All Other, Except Traffic	19	105	474	399	404	298	1,699
Curfew/Loitering	13	149	972	847	707	476	3,164
Runaways	11	242	1,630	1,255	967	465	4,570
PART II SUBTOTAL	92	937	4,951	3,846	3,633	2,709	16,168
TOTAL	160	1,578	6,535	4,839	4,498	3,476	21,086

ADULT MALE ARRESTS

OFFENSE CLASSIFICATION	AGE						
	18	19	20	21	22	23	24
PART I							
Murder/Nonneg. Manslaughter	8	20	10	13	14	8	11
Forcible Rape	14	12	2	10	10	12	7
Robbery	142	86	86	80	41	60	35
Aggravated Assault	286	281	207	216	208	194	198
Burglary	395	275	204	157	118	108	100
Larceny-Theft	1,502	1,199	945	838	647	654	636
Motor Vehicle Theft	199	133	95	74	59	60	46
Arson	11	10	1	10	5	5	3
PART I SUBTOTAL	2,557	2,016	1,550	1,398	1,102	1,101	1,036
PART II							
Manslaughter by Negligence	--	5	--	--	3	3	1
Other Assaults - Simple	586	629	635	742	853	792	743
Forgery and Counterfeiting	66	56	56	54	50	52	52
Fraud	60	47	51	45	45	25	46
Embezzlement	9	5	5	15	9	4	5
Stolen Property	195	135	105	88	89	98	85
Vandalism	427	280	258	257	231	207	209
Weapons: Carrying, Possessing, Etc.	306	266	226	229	190	169	135
Prostitution and Comm. Vice	9	11	13	16	15	17	16
Sex Offenses	31	49	42	67	51	39	45
DRUGS, SALE OR MFG.							
Opium, Cocaine, Derivatives	61	78	81	75	74	67	43
Marijuana	74	69	50	47	35	30	41
Synthetic Narcotics	21	14	23	13	16	8	20
Other Dangerous Nonnarcotics	29	25	25	19	24	33	33
DRUGS, POSSESSION							
Opium, Cocaine, Derivatives	89	86	83	91	77	67	75
Marijuana	921	847	656	505	419	357	344
Synthetic Narcotics	58	48	44	29	46	42	39
Other Dangerous Nonnarcotics	140	98	87	74	70	46	43
All Gambling	1	--	1	1	3	--	--
Offenses Against Family/Children	58	59	57	54	51	36	50
Driving Under the Influence	523	709	794	1,096	1,139	1,278	1,170
Liquor Law Violations	3,139	2,874	2,315	551	369	356	284
Disorderly Conduct	715	605	604	730	677	603	561
Vagrancy	42	39	26	20	21	14	11
All Other, Except Traffic	2,046	2,320	2,212	2,312	2,067	2,128	1,948
PART II SUBTOTAL	9,606	9,354	8,449	7,130	6,624	6,471	5,999
TOTAL	12,163	11,370	9,999	8,528	7,726	7,572	7,035

ADULT MALE ARRESTS (CONT.)

AGE									TOTAL ARRESTS
25-29	30-34	35-39	40-44	45-49	50-54	55-59	60-64	65-Over	
35	21	16	10	4	6	3	2	6	187
46	36	38	16	12	6	1	3	1	226
189	150	108	55	33	7	4	1	--	1,077
815	766	672	471	263	145	61	43	49	4,875
522	426	390	217	84	31	12	6	7	3,052
3,053	3,200	3,045	2,146	1,165	534	273	175	315	20,327
256	201	151	76	31	11	2	1	3	1,398
13	20	11	14	7	6	3	2	1	122
4,929	4,820	4,431	3,005	1,599	746	359	233	382	31,264
3	6	1	2	2	--	--	--	1	27
4,089	3,977	3,240	1,957	1,042	438	209	120	160	20,212
195	201	138	86	38	7	5	1	1	1,058
184	207	188	116	83	37	15	5	10	1,164
35	18	16	7	5	3	1	1	--	138
406	327	206	137	37	32	11	4	6	1,961
995	976	695	432	244	108	53	24	36	5,432
493	361	268	180	76	46	28	6	15	2,994
100	89	92	60	40	32	24	16	30	580
251	317	285	197	156	105	49	44	52	1,780
238	200	132	100	36	14	8	3	2	1,212
165	114	94	73	29	18	7	1	2	849
86	64	63	39	19	11	2	--	--	399
208	210	166	98	35	9	2	--	4	920
379	385	335	223	121	38	22	2	--	2,073
1,346	958	794	472	212	85	37	11	6	7,970
265	221	239	128	57	9	4	5	--	1,234
268	336	259	178	70	18	3	3	7	1,700
3	2	3	7	2	3	2	1	--	29
240	295	258	140	81	35	18	7	9	1,448
5,414	4,798	4,123	2,939	1,992	1,144	656	349	350	28,474
1,269	1,288	1,370	1,253	828	467	341	178	198	17,080
2,529	2,352	2,322	1,464	935	431	225	131	164	15,048
62	79	100	83	50	20	11	13	7	598
9,169	8,664	7,329	4,743	2,721	1,189	624	356	401	50,229
28,392	26,445	22,716	15,114	8,911	4,299	2,357	1,281	1,461	164,609
33,321	31,265	27,147	18,119	10,510	5,045	2,716	1,514	1,843	195,873

ADULT FEMALE ARRESTS

OFFENSE CLASSIFICATION	AGE						
	18	19	20	21	22	23	24
PART I							
Murder/Nonneg. Manslaughter	2	--	--	1	2	--	4
Forcible Rape	--	--	--	--	--	--	--
Robbery	9	7	4	9	4	5	2
Aggravated Assault	28	22	31	36	33	25	28
Burglary	27	12	16	14	17	17	10
Larceny-Theft	512	416	350	319	278	268	278
Motor Vehicle Theft	16	10	8	12	11	4	9
Arson	--	1	1	--	--	--	1
PART I SUBTOTAL	594	468	410	391	345	319	332
PART II							
Manslaughter by Negligence	--	3	1	1	--	--	--
Other Assaults - Simple	174	190	128	168	169	198	190
Forgery and Counterfeiting	14	17	25	11	15	23	16
Fraud	20	26	21	16	26	19	16
Embezzlement	2	3	1	3	3	3	1
Stolen Property	15	13	14	8	8	5	11
Vandalism	46	25	38	39	35	44	40
Weapons: Carrying, Possessing, Etc.	9	6	7	16	7	6	9
Prostitution and Comm. Vice	62	85	78	80	84	63	89
Sex Offenses	8	15	7	3	8	11	8
DRUGS, SALE OR MFG.							
Opium, Cocaine, Derivatives	8	12	10	8	8	8	10
Marijuana	9	3	11	8	11	5	8
Synthetic Narcotics	1	2	5	2	5	6	2
Other Dangerous Nonnarcotics	3	3	8	6	10	9	13
DRUGS, POSSESSION							
Opium, Cocaine, Derivatives	15	22	11	9	11	20	23
Marijuana	135	95	70	70	46	57	45
Synthetic Narcotics	15	9	8	13	6	7	13
Other Dangerous Nonnarcotics	19	20	24	13	9	12	15
All Gambling	--	--	--	--	--	--	--
Offenses Against Family/Children	30	20	28	20	23	24	37
Driving Under the Influence	67	104	117	187	161	166	155
Liquor Law Violations	719	623	403	98	64	47	40
Disorderly Conduct	168	158	158	160	150	130	136
Vagrancy	16	4	12	9	10	5	4
All Other, Except Traffic	424	418	461	399	387	390	393
PART II SUBTOTAL	1,979	1,876	1,646	1,347	1,256	1,258	1,274
TOTAL	2,573	2,344	2,056	1,738	1,601	1,577	1,606

ADULT FEMALE ARRESTS (CONT.)

AGE									TOTAL ARRESTS
25-29	30-34	35-39	40-44	45-49	50-54	55-59	60-64	65-Over	
5	3	3	6	1	--	--	--	--	27
1	--	--	--	--	--	--	1	--	2
16	25	5	6	2	--	2	--	--	96
170	166	152	92	60	9	3	3	5	863
75	50	43	33	9	3	4	1	--	331
1,283	1,377	1,129	752	387	216	97	76	176	7,914
35	40	36	14	3	--	1	--	1	200
4	1	4	1	--	1	1	--	--	15
1,589	1,662	1,372	904	462	229	108	81	182	9,448
1	1	--	1	--	--	--	--	--	8
933	920	761	465	221	89	39	24	28	4,697
89	95	58	41	12	2	3	1	--	422
96	141	98	57	29	16	4	10	3	598
9	8	7	2	3	1	--	--	--	46
52	62	46	12	8	3	2	1	--	260
201	217	168	97	49	22	16	6	7	1,050
19	48	31	12	10	3	1	--	1	214
406	386	319	153	32	6	--	1	--	1,844
43	38	28	16	7	2	--	--	--	199
48	40	32	18	13	3	--	--	--	218
34	32	22	23	10	2	--	2	--	180
26	27	27	16	6	2	2	--	--	129
87	87	70	31	13	6	1	1	--	348
87	125	102	44	18	4	--	--	--	491
214	194	163	92	46	16	3	2	6	1,254
90	111	78	38	13	2	--	--	--	403
112	123	84	57	17	4	--	--	--	509
--	1	--	1	--	--	--	--	1	3
151	180	116	73	26	20	6	3	--	757
761	878	794	600	333	183	101	53	37	4,697
216	203	226	195	102	41	27	13	19	3,036
704	763	670	444	208	112	58	35	31	4,085
28	24	23	17	6	1	3	1	2	165
2,281	2,238	1,821	1,022	491	190	94	66	79	11,154
6,722	6,942	5,744	3,527	1,673	730	360	219	214	36,767
8,311	8,604	7,116	4,431	2,135	959	468	300	396	46,215

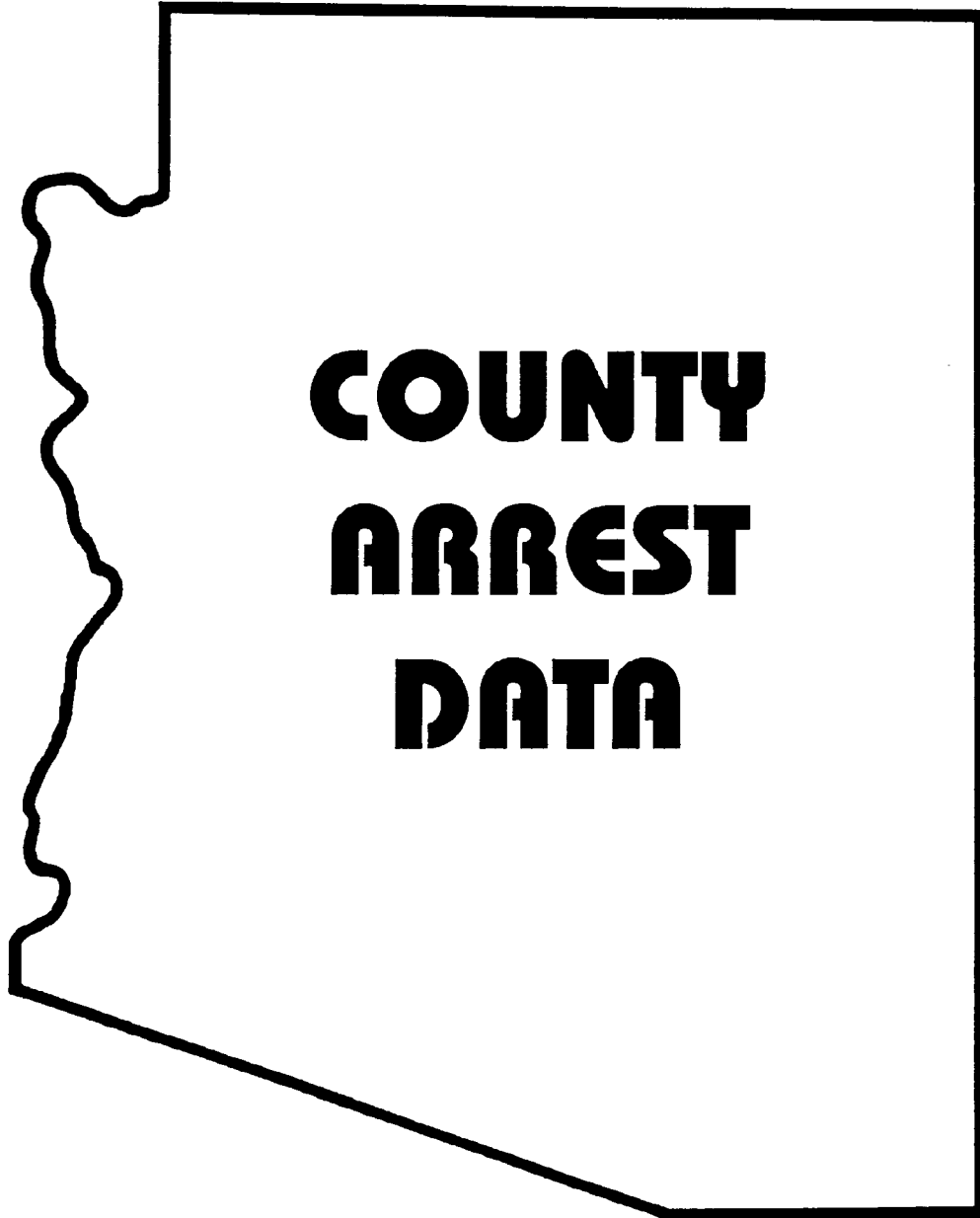

**COUNTY
ARREST
DATA**

APACHE COUNTY - TOTAL ARRESTS BY AGE

OFFENSE CLASSIFICATION	UNDER 10	10-12	13-14	15	16	17	TOTAL UNDER 18	18	19	20	21
PART I											
Murder/Nonneg. Manslaughter	--	--	--	--	--	--	--	--	--	--	--
Forcible Rape	--	--	--	--	1	--	1	--	--	--	--
Robbery	--	--	--	--	--	--	--	1	--	--	--
Aggravated Assault	--	1	3	2	4	3	13	2	1	--	3
Burglary	1	4	13	5	2	17	42	4	5	1	--
Larceny-Theft	2	7	20	13	8	10	60	1	2	1	--
Motor Vehicle Theft	--	1	5	8	--	3	17	--	--	1	1
Arson	--	--	--	--	--	--	--	--	--	--	--
PART I SUBTOTAL	3	13	41	28	15	33	133	8	8	3	4
PART II											
Manslaughter by Negligence	--	--	--	--	--	--	--	--	--	--	--
Other Assaults - Simple	1	7	11	6	10	2	37	6	2	4	3
Forgery and Counterfeiting	--	--	--	--	1	--	1	--	--	--	--
Fraud	--	1	--	--	--	--	1	--	--	--	--
Embezzlement	--	--	--	--	--	--	--	--	--	--	--
Stolen Property	--	--	--	1	1	--	2	6	3	1	--
Vandalism	--	5	--	4	2	--	11	1	1	--	--
Weapons: Carrying, Possessing, Etc.	1	--	--	--	--	--	1	--	--	--	--
Prostitution and Comm. Vice	--	--	--	--	--	--	--	--	--	--	--
Sex Offenses	--	--	1	--	1	--	2	--	--	--	--
DRUGS, SALE OR MFG.											
Opium, Cocaine, Derivatives	--	--	--	1	--	1	2	--	--	--	--
Marijuana	--	2	4	--	--	--	6	2	1	--	--
Synthetic Narcotics	--	--	1	--	--	--	1	--	--	--	--
Other Dangerous Nonnarcotics	--	--	--	--	--	--	--	--	--	--	--
DRUGS, POSSESSION											
Opium, Cocaine, Derivatives	--	--	--	--	--	--	--	--	--	--	--
Marijuana	--	4	8	6	9	9	36	12	10	8	--
Synthetic Narcotics	--	1	1	--	--	--	2	--	1	--	--
Other Dangerous Nonnarcotics	--	--	--	--	--	--	--	--	--	--	--
All Gambling											
Offenses Against Family/Children	--	--	--	--	--	--	--	5	3	--	--
Driving Under the Influence	--	--	--	--	2	2	4	4	3	1	3
Liquor Law Violations	--	4	15	12	20	31	82	16	21	7	2
Disorderly Conduct	--	3	10	12	15	10	50	9	9	3	3
Vagrancy	--	--	--	--	--	--	--	--	--	--	--
All Other, Except Traffic	5	14	23	14	8	5	69	12	10	5	4
Curfew/Loitering (Juvenile)	1	4	5	3	1	1	15	--	--	--	--
Runaways (Juvenile)	--	4	23	7	5	3	42	--	--	--	--
PART II SUBTOTAL	8	49	102	66	75	64	364	73	64	29	15
TOTAL	11	62	143	94	90	97	497	81	72	32	19

APACHE COUNTY - TOTAL ARRESTS BY AGE (CONT.)

22	23	24	25-29	30-34	35-39	40-44	45-49	50-54	55-59	60-64	65 AND OVER	TOTAL OVER 18	TOTAL ALL AGES
--	--	--	--	--	--	--	--	--	--	1	--	1	1
--	--	--	--	1	--	--	--	--	--	--	--	1	2
1	--	--	--	--	--	--	--	--	--	--	--	2	2
--	4	--	7	6	5	8	2	3	2	--	2	45	58
1	--	--	2	1	2	1	--	1	--	--	--	18	60
3	3	3	3	7	7	2	4	--	2	4	--	42	102
--	--	--	2	1	--	--	--	--	--	--	--	5	22
--	--	--	--	1	--	--	--	--	--	--	--	1	1
5	7	3	14	17	14	11	6	4	4	5	2	115	248
--	--	--	--	--	--	--	--	--	--	--	--	--	--
6	3	3	11	10	11	4	3	--	--	--	1	67	104
--	--	--	--	--	--	1	--	--	--	--	--	1	2
--	--	--	--	--	--	--	--	--	--	--	--	--	1
--	--	--	--	--	--	--	--	--	--	--	--	--	--
--	--	--	2	--	--	--	--	--	--	--	--	12	14
1	1	1	--	--	--	--	--	--	--	--	--	5	16
--	--	--	--	--	1	--	--	--	--	--	--	1	2
--	--	--	--	--	--	--	--	--	--	--	--	--	--
1	--	--	1	1	2	--	--	--	--	1	1	7	9
--	--	--	--	--	--	--	--	--	--	--	--	--	2
--	1	1	3	2	2	--	--	--	--	--	1	13	19
--	--	--	--	1	2	--	--	--	--	--	--	3	4
--	--	--	--	1	--	--	--	--	--	--	--	1	1
--	--	--	--	--	1	--	1	--	--	--	--	2	2
2	1	3	4	9	6	3	3	--	--	--	--	61	97
1	--	--	2	1	5	--	--	--	--	--	--	10	12
--	1	--	--	3	2	--	--	--	--	--	--	6	6
--	--	--	--	--	--	--	--	--	--	--	--	--	--
--	--	--	1	1	1	--	1	--	--	--	--	12	12
--	1	2	8	8	14	9	7	2	3	--	1	66	70
3	1	--	11	3	7	1	3	--	1	--	1	77	159
5	8	10	17	15	25	14	5	3	1	--	--	127	177
--	--	--	--	--	--	--	--	--	--	--	--	--	--
8	4	6	14	23	18	13	8	4	2	3	--	134	203
--	--	--	--	--	--	--	--	--	--	--	--	--	15
--	--	--	--	--	--	--	--	--	--	--	--	--	42
27	21	26	74	78	97	45	31	9	7	4	5	605	969
32	28	29	88	95	111	56	37	13	11	9	7	720	1,217

COCHISE COUNTY - TOTAL ARRESTS BY AGE

OFFENSE CLASSIFICATION	UNDER 10	10-12	13-14	15	16	17	TOTAL UNDER 18	18	19	20	21
PART I											
Murder/Nonneg. Manslaughter	--	--	--	--	--	1	1	--	1	--	--
Forcible Rape	--	--	--	--	--	--	--	--	--	--	--
Robbery	--	--	--	--	1	1	2	--	1	2	2
Aggravated Assault	2	2	3	3	5	7	22	5	3	9	3
Burglary	--	2	8	30	16	8	64	10	10	5	6
Larceny-Theft	8	32	88	61	53	38	280	36	17	17	13
Motor Vehicle Theft	--	1	6	5	7	3	22	--	3	--	2
Arson	--	1	2	--	--	1	4	--	--	--	--
PART I SUBTOTAL	10	38	107	99	82	59	395	51	35	33	26
PART II											
Manslaughter by Negligence	--	--	--	--	--	--	--	--	--	--	--
Other Assaults - Simple	6	24	58	31	28	17	164	12	5	11	10
Forgery and Counterfeiting	--	--	1	2	2	1	6	1	2	--	--
Fraud	--	--	--	--	--	--	--	2	7	3	5
Embezzlement	--	--	--	--	--	--	--	--	1	--	--
Stolen Property	--	--	--	1	--	1	2	2	--	--	1
Vandalism	--	17	28	12	17	8	82	5	4	4	3
Weapons: Carrying, Possessing, Etc.	--	3	3	2	1	2	14	2	1	--	--
Prostitution and Comm. Vice	--	--	--	--	--	--	--	--	--	--	--
Sex Offenses	--	--	1	--	2	--	3	1	2	--	1
DRUGS, SALE OR MFG.											
Opium, Cocaine, Derivatives	--	--	--	--	--	--	--	--	--	--	--
Marijuana	--	2	3	2	3	4	14	1	6	4	3
Synthetic Narcotics	--	--	--	--	--	1	1	--	--	--	--
Other Dangerous Nonnarcotics	--	--	--	--	--	1	1	1	--	--	1
DRUGS, POSSESSION											
Opium, Cocaine, Derivatives	--	--	2	--	--	1	3	--	--	--	--
Marijuana	--	2	14	28	24	23	91	17	11	7	7
Synthetic Narcotics	--	--	--	--	--	1	1	--	--	--	--
Other Dangerous Nonnarcotics	--	--	1	1	--	2	4	--	2	3	1
All Gambling											
All Gambling	--	--	--	--	--	--	--	--	--	--	--
Offenses Against Family/Children											
Offenses Against Family/Children	--	2	12	10	16	7	47	11	11	12	7
Driving Under the Influence											
Driving Under the Influence	1	--	--	1	2	--	4	11	14	5	12
Liquor Law Violations											
Liquor Law Violations	1	3	8	19	19	18	68	34	19	24	1
Disorderly Conduct											
Disorderly Conduct	5	11	50	29	34	20	149	20	16	13	23
Vagrancy											
Vagrancy	--	--	--	--	--	--	--	--	--	--	--
All Other, Except Traffic											
All Other, Except Traffic	8	21	52	44	57	49	231	22	37	41	41
Curfew/Loitering (Juvenile)											
Curfew/Loitering (Juvenile)	--	5	28	25	18	23	99	--	--	--	--
Runaways (Juvenile)											
Runaways (Juvenile)	2	20	87	112	87	68	376	--	--	--	--
PART II SUBTOTAL	23	110	348	319	313	247	1,360	142	138	127	116
TOTAL	33	148	455	418	395	306	1,755	193	173	160	142

COCHISE COUNTY - TOTAL ARRESTS BY AGE (CONT.)

22	23	24	25-29	30-34	35-39	40-44	45-49	50-54	55-59	60-64	65 AND OVER	TOTAL OVER 18	TOTAL ALL AGES
--	--	--	--	1	--	--	--	--	--	--	--	2	3
--	--	--	2	1	1	--	--	--	--	--	--	4	4
3	--	--	1	--	2	1	--	--	--	--	--	12	14
3	1	2	8	7	11	8	13	4	4	--	--	81	103
4	--	1	7	2	4	2	1	--	--	--	--	52	116
23	6	5	32	49	33	28	10	9	8	1	7	294	574
--	--	--	2	1	2	3	--	--	--	--	--	13	35
--	--	--	--	--	--	1	--	--	--	--	--	1	5
33	7	8	52	61	53	43	24	13	12	1	7	459	854
--	--	--	--	--	--	--	--	--	--	--	--	--	--
6	8	13	33	47	40	25	13	5	3	1	5	237	401
--	--	--	2	2	1	--	2	1	--	--	--	11	17
6	4	4	11	19	8	6	5	4	1	--	1	86	86
--	--	--	3	1	2	--	--	--	--	--	--	7	7
2	1	--	1	--	--	--	--	--	--	1	--	8	10
3	3	4	7	10	5	9	3	--	--	--	--	60	142
2	--	--	2	1	1	--	--	1	--	--	--	10	24
--	--	--	--	--	--	--	--	--	--	--	--	--	--
1	--	1	1	3	--	--	--	1	--	--	1	12	15
--	--	--	1	--	1	--	--	--	--	--	--	2	2
1	1	2	8	4	2	2	--	--	--	1	1	36	50
--	--	--	1	1	2	--	--	--	--	--	--	4	5
--	--	--	--	1	--	--	1	--	--	--	--	4	5
--	--	--	--	2	1	1	--	--	1	--	--	5	8
4	7	2	24	19	24	10	8	2	--	2	1	145	236
--	--	--	--	--	--	--	--	--	--	--	--	--	1
--	1	--	8	5	4	4	2	--	1	--	--	31	35
--	--	--	--	--	--	--	--	--	--	--	--	--	--
13	14	14	48	89	67	37	20	11	4	2	--	360	407
10	20	9	53	76	61	67	25	17	5	9	5	399	403
3	2	2	4	6	8	5	4	1	2	1	--	116	184
9	9	11	48	55	61	31	14	11	10	4	2	337	486
--	--	--	--	--	--	--	--	--	--	--	--	--	--
30	24	30	141	151	137	76	47	19	17	10	5	828	1,059
--	--	--	--	--	--	--	--	--	--	--	--	--	99
--	--	--	--	--	--	--	--	--	--	--	--	--	376
90	94	92	396	492	425	273	144	73	44	31	21	2,698	4,058
123	101	100	448	553	478	316	168	86	56	32	28	3,157	4,912

COCONINO COUNTY - TOTAL ARRESTS BY AGE

OFFENSE CLASSIFICATION	UNDER 10	10-12	13-14	15	16	17	TOTAL UNDER 18	18	19	20	21
PART I											
Murder/Nonneg. Manslaughter	--	--	--	--	1	--	1	--	1	--	--
Forcible Rape	--	--	--	1	2	1	4	--	3	1	1
Robbery	--	1	2	--	1	1	5	4	--	4	--
Aggravated Assault	2	8	22	9	16	22	79	17	20	10	21
Burglary	6	16	42	14	35	14	127	22	12	5	2
Larceny-Theft	9	38	105	71	83	90	396	131	104	82	65
Motor Vehicle Theft	--	--	8	5	4	7	24	4	2	3	1
Arson	--	3	2	--	--	--	5	2	1	--	3
PART I SUBTOTAL	17	66	181	100	142	135	641	180	143	105	93
PART II											
Manslaughter by Negligence	--	--	--	--	--	--	--	--	--	--	--
Other Assaults - Simple	2	13	27	35	23	20	120	23	26	31	49
Forgery and Counterfeiting	--	--	1	3	1	1	6	3	2	5	4
Fraud	--	1	--	--	1	3	5	17	7	1	--
Embezzlement	--	--	--	--	--	--	--	--	--	--	--
Stolen Property	--	--	1	--	--	--	1	1	1	1	--
Vandalism	9	10	24	16	30	21	110	17	16	25	25
Weapons: Carrying, Possesing, Etc.	--	--	6	--	4	2	12	3	4	2	3
Prostitution and Comm. Vice	--	--	--	--	--	--	--	--	--	--	1
Sex Offenses	2	2	7	1	3	1	16	--	4	1	5
DRUGS, SALE OR MFG.											
Opium, Cocaine, Derivatives	--	--	--	--	--	--	--	--	--	1	--
Marijuana	1	2	3	1	2	6	15	12	5	5	1
Synthetic Narcotics	--	--	2	--	--	--	2	--	--	--	--
Other Dangerous Nonnarcotics	--	--	--	1	--	--	1	--	--	--	--
DRUGS, POSSESSION											
Opium, Cocaine, Derivatives	--	--	--	--	5	3	8	6	6	5	4
Marijuana	--	1	24	24	26	27	102	59	63	67	45
Synthetic Narcotics	--	1	6	--	2	2	11	--	2	--	--
Other Dangerous Nonnarcotics	--	--	--	--	--	2	2	4	6	3	2
All Gambling											
Offenses Against Family/Children	--	--	3	--	1	10	14	15	14	16	15
Driving Under the Influence	2	--	2	4	6	20	34	30	77	74	120
Liquor Law Violations	3	2	50	65	133	143	396	119	135	108	31
Disorderly Conduct	3	12	41	37	46	30	169	68	111	131	152
Vagrancy	--	--	--	--	--	--	--	2	2	--	--
All Other, Except Traffic	10	23	119	130	140	96	518	184	231	314	295
Curfew/Loitering (Juvenile)	--	1	2	3	6	5	17	--	--	--	--
Runaways (Juvenile)	1	6	52	50	38	18	165	--	--	--	--
PART II SUBTOTAL	33	74	370	370	467	410	1,724	563	712	790	752
TOTAL	50	140	551	470	609	545	2,365	743	855	895	845

COCONINO COUNTY - TOTAL ARRESTS BY AGE (CONT.)

22	23	24	25-29	30-34	35-39	40-44	45-49	50-54	55-59	60-64	65 AND OVER	TOTAL OVER 18	TOTAL ALL AGES
--	--	--	--	2	--	--	--	--	1	--	--	4	5
--	3	--	--	1	1	1	1	2	--	--	--	14	18
--	2	1	3	2	1	1	--	--	--	--	--	18	23
20	6	15	40	45	30	35	16	14	2	1	1	293	372
3	6	4	23	14	14	7	4	--	--	--	1	117	244
48	50	25	168	143	124	91	64	25	11	5	9	1,145	1,541
2	--	--	7	3	1	--	1	1	1	--	--	26	50
3	1	--	2	8	2	2	3	2	1	--	--	30	35
76	68	45	243	218	173	137	89	44	16	6	11	1,647	2,288
--	--	--	--	--	--	--	--	--	--	--	--	--	--
40	39	46	242	185	134	87	54	14	2	9	2	983	1,103
5	1	4	8	20	3	11	1	--	1	--	--	68	74
2	1	1	3	15	9	6	3	1	--	--	--	66	71
--	--	--	--	--	--	--	--	--	--	--	--	--	--
--	1	--	4	--	2	--	--	--	--	--	--	10	11
25	14	15	91	65	50	25	22	7	2	--	2	401	511
3	2	2	8	7	7	5	4	--	2	--	1	59	71
--	--	--	--	1	--	--	--	--	--	--	--	2	2
9	7	7	25	33	17	20	26	9	1	2	3	169	185
--	1	--	1	2	--	4	--	--	--	--	--	9	9
1	1	1	2	3	2	--	--	--	--	--	--	33	48
--	--	--	--	--	--	--	--	--	--	--	--	--	2
--	--	--	--	3	1	2	1	--	--	--	--	7	8
1	3	1	12	3	5	4	3	--	--	--	--	53	61
33	20	25	69	46	40	20	4	5	2	1	1	500	602
--	--	--	4	2	3	6	--	--	--	--	--	17	28
7	--	2	13	14	5	9	2	--	--	--	--	67	69
--	--	--	--	--	--	--	--	--	--	--	--	--	--
9	10	11	62	67	54	33	13	6	3	--	1	329	343
158	164	104	519	363	299	186	125	50	26	12	6	2,313	2,347
30	18	17	98	89	61	67	46	20	15	16	13	883	1,279
147	100	112	420	391	327	233	140	48	24	15	13	2,432	2,601
--	1	--	5	12	8	19	7	1	--	3	--	60	60
274	305	232	1,259	1,023	787	536	371	126	63	51	43	6,094	6,612
--	--	--	--	--	--	--	--	--	--	--	--	--	17
--	--	--	--	--	--	--	--	--	--	--	--	--	165
750	688	580	2,845	2,344	1,814	1,273	822	287	141	109	85	14,555	16,279
826	756	625	3,088	2,562	1,987	1,410	911	331	157	115	96	16,202	18,567

GILA COUNTY - TOTAL ARRESTS BY AGE

OFFENSE CLASSIFICATION	UNDER	10-12	13-14	15	16	17	TOTAL	18	19	20	21
	10						UNDER 18				
PART I											
Murder/Nonneg. Manslaughter	--	--	--	--	--	--	--	--	--	--	--
Forcible Rape	--	--	--	--	--	--	--	--	--	--	--
Robbery	--	--	--	--	--	--	--	1	--	1	--
Aggravated Assault	2	1	7	3	7	1	21	3	2	7	1
Burglary	2	10	22	10	7	5	56	6	--	4	1
Larceny-Theft	6	45	65	36	34	19	205	14	7	8	11
Motor Vehicle Theft	--	--	4	7	5	1	17	3	1	1	--
Arson	--	--	1	1	--	--	2	--	--	--	--
PART I SUBTOTAL	10	56	99	57	53	26	301	27	10	21	13
PART II											
Manslaughter by Negligence	--	--	--	--	--	--	--	--	--	--	--
Other Assaults - Simple	1	12	30	17	23	9	92	9	2	5	4
Forgery and Counterfeiting	--	--	--	--	1	--	1	--	1	1	--
Fraud	--	--	--	--	--	2	2	--	--	--	--
Embezzlement	--	--	--	--	--	--	--	--	--	--	1
Stolen Property	1	--	--	--	--	1	2	--	--	1	1
Vandalism	3	10	29	9	15	14	80	10	5	2	8
Weapons: Carrying, Possessing, Etc.	1	3	3	--	2	1	10	1	2	--	--
Prostitution and Comm. Vice	--	--	--	--	--	--	--	--	--	--	--
Sex Offenses	1	--	--	--	1	--	2	--	1	1	--
DRUGS, SALE OR MFG.											
Opium, Cocaine, Derivatives	--	--	--	--	--	--	--	--	--	--	--
Marijuana	--	--	1	--	--	--	1	1	--	--	--
Synthetic Narcotics	--	--	--	--	--	--	--	--	--	--	--
Other Dangerous Nonnarcotics	--	--	--	--	--	--	--	--	--	--	--
DRUGS, POSSESSION											
Opium, Cocaine, Derivatives	--	1	1	--	1	--	3	--	--	--	--
Marijuana	--	1	8	15	10	9	43	13	12	9	5
Synthetic Narcotics	--	--	--	--	1	--	1	--	--	--	1
Other Dangerous Nonnarcotics	--	1	1	--	1	--	3	--	--	--	1
All Gambling											
Offenses Against Family/Children	--	--	5	3	1	2	11	9	4	11	9
Driving Under the Influence	3	--	--	--	2	4	9	5	11	6	15
Liquor Law Violations	1	6	20	20	45	51	143	67	47	38	9
Disorderly Conduct	2	6	30	28	16	29	111	20	16	18	25
Vagrancy	--	--	--	2	2	1	5	--	--	--	--
All Other, Except Traffic	6	18	41	36	31	39	171	36	41	36	41
Curfew/Loitering (Juvenile)	--	2	2	1	2	1	8	--	--	--	--
Runaways (Juvenile)	--	2	37	18	18	8	83	--	--	--	--
PART II SUBTOTAL	19	62	208	149	172	171	781	171	142	128	120
TOTAL	29	118	307	206	225	197	1,082	198	152	149	133

GILA COUNTY - TOTAL ARRESTS BY AGE (CONT.)

22	23	24	25-29	30-34	35-39	40-44	45-49	50-54	55-59	60-64	65 AND OVER	TOTAL OVER 18	TOTAL ALL AGES
--	--	--	--	--	--	--	--	1	--	--	--	1	1
--	--	--	--	--	--	--	--	--	--	--	--	--	--
--	--	--	1	--	1	2	--	--	--	--	--	6	6
3	7	7	15	11	13	10	4	1	--	1	--	85	106
2	2	--	4	4	3	3	2	--	1	--	1	33	89
7	12	4	29	35	19	23	18	9	4	4	9	213	418
1	--	--	2	3	2	--	--	--	--	--	--	13	30
--	--	--	--	--	--	--	--	--	--	--	--	--	2
13	21	11	51	53	38	38	24	11	5	5	10	351	652
--	--	--	--	--	--	--	--	--	--	--	--	--	--
2	7	4	41	35	44	16	17	8	2	2	3	201	293
--	--	--	3	2	1	1	--	--	--	--	--	9	10
--	--	1	1	2	--	2	2	--	--	--	1	9	11
1	--	--	1	--	--	2	--	--	--	--	--	5	5
--	--	--	--	--	3	--	--	--	--	--	--	5	7
2	1	--	1	11	4	3	1	--	1	2	1	52	132
--	1	--	2	7	1	1	2	--	1	--	--	18	28
--	--	--	--	--	--	--	--	--	--	--	--	--	--
--	--	--	1	4	2	1	--	--	1	--	--	11	13
1	--	--	1	--	--	--	--	--	--	--	--	2	2
--	--	--	2	3	--	--	--	--	--	--	--	6	7
--	--	--	--	--	1	--	--	--	--	--	--	1	1
--	--	--	--	2	--	--	--	--	--	--	--	2	2
--	--	--	1	1	--	--	--	--	--	--	--	2	5
3	1	2	12	9	8	3	2	--	--	--	--	79	122
--	--	1	--	9	1	3	--	--	--	--	--	15	16
--	--	--	2	2	1	--	--	1	--	--	--	7	10
--	--	--	--	--	--	--	--	--	--	--	--	--	--
8	4	13	18	41	28	25	7	4	1	4	--	186	197
9	20	16	90	91	84	59	38	21	17	10	5	497	506
6	2	3	2	6	4	5	7	1	2	--	1	200	343
20	23	23	94	103	89	64	38	14	11	3	2	563	674
--	--	--	1	--	--	1	1	--	--	--	--	3	8
21	40	39	173	196	166	111	70	39	11	7	5	1,032	1,203
--	--	--	--	--	--	--	--	--	--	--	--	--	8
--	--	--	--	--	--	--	--	--	--	--	--	--	83
73	99	102	446	524	437	297	185	88	47	28	18	2,905	3,686
86	120	113	497	577	475	335	209	99	52	33	28	3,256	4,338

GRAHAM COUNTY - TOTAL ARRESTS BY AGE

OFFENSE CLASSIFICATION	UNDER	10-12	13-14	15	16	17	TOTAL	18	19	20	21
	10						UNDER 18				
PART I											
Murder/Nonneg. Manslaughter	--	--	--	--	--	--	--	--	--	--	--
Forcible Rape	--	--	--	--	--	--	--	--	--	--	--
Robbery	--	--	1	--	--	--	1	--	--	--	--
Aggravated Assault	--	3	10	1	4	3	21	3	--	1	1
Burglary	1	4	7	1	3	--	16	1	1	--	1
Larceny-Theft	--	15	46	19	17	23	120	19	11	15	9
Motor Vehicle Theft	--	--	--	1	--	--	1	2	--	--	--
Arson	--	4	1	--	1	--	6	--	--	--	1
PART I SUBTOTAL	1	26	65	22	25	26	165	25	12	16	12
PART II											
Manslaughter by Negligence	--	--	--	--	--	--	--	--	--	--	--
Other Assaults - Simple	--	--	3	4	3	6	16	3	3	2	1
Forgery and Counterfeiting	--	--	1	--	--	1	2	--	--	2	1
Fraud	--	1	1	--	--	--	2	--	--	--	--
Embezzlement	--	--	--	--	--	--	--	--	--	--	--
Stolen Property	--	--	--	1	--	--	1	--	--	--	--
Vandalism	--	9	11	9	5	4	38	5	1	3	2
Weapons: Carrying, Possessing, Etc.	--	2	--	--	--	--	2	--	--	--	--
Prostitution and Comm. Vice	--	--	--	--	--	--	--	--	--	--	--
Sex Offenses	--	--	2	--	--	--	2	--	--	--	--
DRUGS, SALE OR MFG.											
Opium, Cocaine, Derivatives	--	--	--	--	--	--	--	--	--	--	--
Marijuana	--	--	--	--	--	--	--	1	--	--	--
Synthetic Narcotics	--	--	--	--	--	1	1	--	--	--	--
Other Dangerous Nonnarcotics	--	--	--	--	--	--	--	--	--	--	--
DRUGS, POSSESSION											
Opium, Cocaine, Derivatives	--	--	--	--	--	--	--	--	--	--	--
Marijuana	--	1	3	4	5	8	21	5	6	3	3
Synthetic Narcotics	--	--	--	--	3	--	3	--	--	--	--
Other Dangerous Nonnarcotics	--	--	4	1	7	2	14	--	2	4	--
All Gambling											
Offenses Against Family/Children	--	--	--	--	2	2	4	--	--	--	--
Driving Under the Influence	--	--	--	--	1	--	1	3	4	3	8
Liquor Law Violations	--	--	3	11	22	36	72	37	31	18	4
Disorderly Conduct	--	2	17	11	16	9	55	5	6	4	8
Vagrancy	--	--	--	--	--	1	1	--	--	--	--
All Other, Except Traffic	1	14	49	28	30	11	133	6	15	5	4
Curfew/Loitering (Juvenile)	--	5	8	7	5	1	26	--	--	--	--
Runaways (Juvenile)	1	1	12	1	2	2	19	--	--	--	--
PART II SUBTOTAL	2	35	114	77	101	84	413	65	68	44	31
TOTAL	3	61	179	99	126	110	578	90	80	60	43

GRAHAM COUNTY - TOTAL ARRESTS BY AGE (CONT.)

22	23	24	25-29	30-34	35-39	40-44	45-49	50-54	55-59	60-64	65 AND OVER	TOTAL OVER 18	TOTAL ALL AGES
--	--	--	--	--	--	--	--	--	--	--	--	--	--
--	--	--	--	--	--	--	--	--	--	--	--	--	--
--	--	--	--	--	--	--	--	--	--	--	--	--	1
3	--	3	7	15	9	3	1	1	--	--	2	49	70
1	1	--	--	1	--	--	--	--	--	--	--	6	22
7	14	5	17	24	15	16	6	5	3	--	6	172	292
2	1	--	--	--	--	--	--	--	--	--	--	5	6
--	--	--	--	--	--	--	--	--	--	--	--	1	7
13	16	8	24	40	24	19	7	6	3	--	8	233	398
--	--	--	--	--	--	--	--	--	--	--	--	--	--
5	2	2	11	10	4	6	--	--	--	--	--	49	65
1	--	--	3	1	1	1	--	--	--	--	--	10	12
2	--	--	1	1	1	--	--	--	--	--	--	5	7
--	--	--	1	--	--	--	--	--	--	--	--	1	1
--	--	--	--	--	--	3	--	--	--	--	--	3	4
--	1	1	3	2	1	1	--	--	1	--	--	21	59
--	--	--	--	2	--	--	--	--	--	--	--	2	4
--	--	--	--	--	--	--	--	--	--	--	--	--	--
--	1	--	--	--	1	--	--	--	--	--	--	2	4
--	--	--	--	--	--	--	--	--	--	--	--	--	--
1	--	--	--	--	--	--	--	--	--	--	--	--	--
1	--	--	--	--	--	--	--	1	--	--	--	3	3
--	--	--	--	--	--	--	--	--	--	--	--	--	1
--	--	--	--	1	--	--	--	1	--	--	--	2	2
1	--	--	1	3	--	--	--	--	--	--	--	5	5
--	--	1	6	2	3	1	1	--	--	--	--	31	52
--	1	--	2	--	1	--	1	--	--	--	--	5	8
1	--	--	3	7	3	--	2	--	--	--	--	22	36
--	--	--	--	--	--	--	--	--	--	--	--	--	--
--	--	1	13	14	6	5	1	1	--	--	--	41	45
5	1	6	21	20	8	8	8	7	2	2	3	109	110
5	--	--	5	3	5	4	--	1	1	1	1	116	188
5	7	10	26	32	22	19	6	4	7	4	1	166	221
--	--	--	--	--	--	--	--	--	--	--	--	--	1
6	7	6	21	17	22	10	11	6	1	2	3	142	275
--	--	--	--	--	--	--	--	--	--	--	--	--	26
--	--	--	--	--	--	--	--	--	--	--	--	--	19
32	20	27	117	115	78	58	30	21	12	9	8	735	1,148
45	36	35	141	155	102	77	37	27	15	9	16	968	1,546

GREENLEE COUNTY - TOTAL ARRESTS BY AGE

OFFENSE CLASSIFICATION	UNDER 10	10-12	13-14	15	16	17	TOTAL UNDER 18	18	19	20	21
PART I											
Murder, Nonneg. Manslaughter	--	--	--	--	--	--	--	--	--	--	--
Forcible Rape	--	--	--	--	--	--	--	--	--	--	--
Robbery	--	--	--	--	--	--	--	--	--	--	--
Aggravated Assault	--	--	--	1	1	1	3	--	--	--	--
Burglary	--	--	2	--	4	--	6	--	--	--	--
Larceny-Theft	1	3	--	4	4	3	15	3	--	--	--
Motor Vehicle Theft	--	--	--	--	--	--	--	--	--	--	--
Arson	--	--	--	--	--	--	--	--	--	--	--
PART I SUBTOTAL	1	3	2	5	9	4	24	3	--	--	--
PART II											
Manslaughter by Negligence	--	--	--	--	--	--	--	--	--	--	--
Other Assaults - Simple	--	--	6	2	3	--	11	1	1	1	--
Forgery and Counterfeiting	--	--	1	--	--	--	1	--	--	--	--
Fraud	--	--	--	--	--	--	--	--	--	--	--
Embezzlement	--	--	--	--	--	--	--	--	--	--	--
Stolen Property	--	--	--	--	--	--	--	--	--	--	--
Vandalism	--	2	3	1	3	--	9	1	--	--	--
Weapons: Carrying, Possessing, Etc.	--	--	--	--	--	--	--	--	--	--	--
Prostitution and Comm. Vice	--	--	--	--	--	--	--	--	--	--	--
Sex Offenses	--	1	--	--	--	--	1	--	--	--	--
DRUGS, SALE OR MFG.											
Opium, Cocaine, Derivatives	--	--	--	--	--	--	--	--	--	--	--
Marijuana	--	--	--	--	--	--	--	--	--	--	--
Synthetic Narcotics	--	--	--	--	--	--	--	--	--	--	--
Other Dangerous Nonnarcotics	--	--	--	--	--	--	--	--	--	--	--
DRUGS, POSSESSION											
Opium, Cocaine, Derivatives	--	--	--	--	--	--	--	--	--	--	--
Marijuana	--	--	--	--	2	4	6	1	3	2	3
Synthetic Narcotics	--	--	--	--	--	--	--	--	--	--	--
Other Dangerous Nonnarcotics	--	--	--	--	--	--	--	--	--	--	--
All Gambling											
All Gambling	--	--	--	--	--	--	--	--	--	--	--
Offenses Against Family/Children											
Offenses Against Family/Children	--	--	--	--	--	--	--	--	--	--	--
Driving Under the Influence											
Driving Under the Influence	--	--	--	1	1	1	3	--	1	--	--
Liquor Law Violations											
Liquor Law Violations	--	--	2	2	7	9	20	3	6	2	2
Disorderly Conduct											
Disorderly Conduct	1	--	5	1	7	3	17	4	--	2	3
Vagrancy											
Vagrancy	--	--	1	--	--	--	1	--	--	--	--
All Other, Except Traffic											
All Other, Except Traffic	--	1	3	1	3	1	9	3	1	7	6
Curfew/Loitering (Juvenile)											
Curfew/Loitering (Juvenile)	--	1	2	4	5	1	13	--	--	--	--
Runaways (Juvenile)											
Runaways (Juvenile)	--	2	--	1	6	1	10	--	--	--	--
PART II SUBTOTAL	1	7	23	13	37	20	101	13	12	14	14
TOTAL	2	10	25	18	46	24	125	16	12	14	14

GREENLEE COUNTY - TOTAL ARRESTS BY AGE (CONT.)

22	23	24	25-29	30-34	35-39	40-44	45-49	50-54	55-59	60-64	65 AND OVER	TOTAL OVER 18	TOTAL ALL AGES
--	--	--	--	--	--	--	--	--	--	--	--	--	--
--	--	--	--	--	--	--	--	--	--	--	--	--	--
--	--	--	--	--	--	--	--	--	--	--	--	--	--
1	--	--	4	1	--	--	--	--	--	--	--	6	9
--	--	--	--	--	--	--	--	--	--	--	--	--	6
1	--	1	--	1	--	--	1	--	--	--	--	7	22
--	--	--	--	--	--	--	--	--	--	--	--	--	--
--	--	--	--	--	--	--	--	--	--	--	--	--	--
2	--	1	4	2	--	--	1	--	--	--	--	13	37
--	--	--	--	--	--	--	--	--	--	--	--	--	--
--	1	1	4	6	5	6	--	--	--	--	--	26	37
--	--	--	--	--	--	1	--	--	--	--	--	1	2
--	--	--	--	--	--	--	--	--	--	--	--	--	--
--	--	--	--	--	--	--	--	--	--	--	--	--	--
--	--	--	1	--	--	--	--	--	--	--	--	2	11
--	--	--	--	--	--	--	--	--	--	--	--	--	--
--	--	--	--	1	1	--	--	--	--	--	--	2	3
--	--	--	--	--	--	--	--	--	--	--	--	--	--
--	--	--	--	--	--	--	--	--	--	--	--	--	--
--	--	--	--	--	--	--	--	--	--	--	--	--	--
--	--	--	--	--	--	--	--	--	--	--	--	--	--
3	2	--	2	4	2	1	1	--	--	--	--	24	30
--	--	--	1	1	--	1	--	--	--	--	--	3	3
--	--	--	--	--	--	--	--	--	--	--	--	--	--
--	--	--	--	--	--	--	--	--	--	--	--	--	--
1	1	--	2	2	6	4	1	1	1	--	--	20	23
1	--	--	2	--	1	--	--	--	--	--	--	17	37
1	6	2	14	17	7	11	4	3	1	--	--	75	92
--	--	--	--	--	--	--	--	--	--	--	--	--	1
1	7	4	20	15	11	11	2	2	1	1	1	93	102
--	--	--	--	--	--	--	--	--	--	--	--	--	13
--	--	--	--	--	--	--	--	--	--	--	--	--	10
7	17	7	46	46	33	35	8	6	3	1	1	263	364
9	17	8	50	48	33	35	9	6	3	1	1	276	401

LA PAZ COUNTY - TOTAL ARRESTS BY AGE*

*La Paz County Sheriff's Office provided data for only two (2) months. Parker Police Department was not able to provide arrest data for 1996.

OFFENSE CLASSIFICATION	UNDER 10	10-12	13-14	15	16	17	TOTAL UNDER 18	18	19	20	21
PART I											
Murder/Nonneg. Manslaughter	--	--	--	--	--	--	--	--	--	--	--
Forcible Rape	--	--	--	--	--	--	--	--	--	--	--
Robbery	--	--	--	--	--	--	--	--	--	--	--
Aggravated Assault	--	--	--	--	--	--	--	--	--	--	--
Burglary	--	--	--	--	--	1	1	--	1	--	--
Larceny-Theft	--	--	1	--	--	--	1	1	--	--	1
Motor Vehicle Theft	--	--	--	1	2	--	3	1	--	--	--
Arson	--	--	--	--	--	--	--	--	--	--	--
PART I SUBTOTAL	--	--	1	1	2	1	5	2	1	--	1
PART II											
Manslaughter by Negligence	--	--	--	--	--	--	--	--	--	--	--
Other Assaults - Simple	--	--	--	--	1	--	1	--	--	--	--
Forgery and Counterfeiting	--	--	--	--	--	--	--	--	--	--	--
Fraud	--	--	--	--	--	--	--	--	--	--	--
Embezzlement	--	--	--	--	--	--	--	--	--	--	--
Stolen Property	--	--	--	--	--	1	1	1	--	--	1
Vandalism	--	--	--	--	--	--	--	--	--	--	--
Weapons: Carrying, Possessing, Etc.	--	--	1	--	--	--	1	--	--	--	--
Prostitution and Comm. Vice	--	--	--	--	--	--	--	--	--	--	--
Sex Offenses	--	--	--	--	--	--	--	--	--	--	--
DRUGS, SALE OR MFG.											
Opium, Cocaine, Derivatives	--	--	--	--	--	--	--	--	--	--	--
Marijuana	--	--	--	--	--	--	--	--	--	--	--
Synthetic Narcotics	--	--	--	--	--	--	--	--	--	--	--
Other Dangerous Nonnarcotics	--	--	--	--	--	--	--	--	--	--	--
DRUGS, POSSESSION											
Opium, Cocaine, Derivatives	--	--	--	--	--	--	--	--	--	--	--
Marijuana	--	1	1	1	--	--	3	--	--	--	--
Synthetic Narcotics	--	--	--	--	--	--	--	--	--	--	--
Other Dangerous Nonnarcotics	--	--	--	--	--	--	--	--	--	--	--
All Gambling											
Offenses Against Family/Children	--	--	--	1	--	--	1	--	--	--	--
Driving Under the Influence	--	--	--	--	--	--	--	1	--	--	2
Liquor Law Violations	--	--	--	--	1	1	2	7	5	7	1
Disorderly Conduct	--	--	1	--	--	2	3	1	--	--	--
Vagrancy	--	--	--	--	--	--	--	--	--	--	--
All Other, Except Traffic	--	--	--	--	--	--	--	1	2	3	3
Curfew/Loitering (Juvenile)	--	--	--	--	--	--	--	--	--	--	--
Runaways (Juvenile)	--	--	--	1	1	1	3	--	--	--	--
PART II SUBTOTAL	--	1	3	3	3	5	15	11	7	10	7
TOTAL	--	1	4	4	5	6	20	13	8	10	8

LA PAZ COUNTY - TOTAL ARRESTS BY AGE (CONT.)

22	23	24	25-29	30-34	35-39	40-44	45-49	50-54	55-59	60-64	65 AND OVER	TOTAL OVER 18	TOTAL ALL AGES
--	--	--	--	--	--	--	--	--	--	--	--	--	--
--	--	--	--	--	--	--	--	--	--	--	--	--	--
--	--	--	--	--	--	--	1	--	--	--	--	1	1
--	--	--	1	1	1	1	--	--	--	--	1	5	5
--	--	--	--	--	2	--	--	--	--	--	--	3	4
--	--	1	4	4	--	--	1	--	--	2	1	15	16
--	--	--	--	--	--	--	1	--	--	--	--	2	5
--	--	--	--	--	--	--	--	--	--	--	--	--	--
--	--	1	5	5	3	1	3	--	--	2	2	26	31
--	--	--	--	--	--	--	--	--	--	--	--	--	--
3	--	--	--	3	5	4	2	2	2	1	--	22	23
--	--	--	--	--	--	--	--	--	--	--	--	--	--
--	--	--	--	--	--	--	--	--	--	--	--	--	--
--	--	--	5	3	2	2	--	1	--	--	--	15	16
--	--	--	1	--	--	--	--	--	--	--	--	1	1
--	--	--	--	--	1	1	1	--	--	--	--	3	4
--	--	--	--	--	--	--	--	--	--	--	--	--	--
--	--	--	--	1	--	--	--	--	--	--	--	1	1
--	--	--	--	--	--	--	--	--	--	--	--	--	--
--	--	--	--	--	--	--	--	--	--	--	--	--	--
--	--	--	--	--	--	--	--	--	--	--	--	--	--
--	--	--	--	--	--	--	--	--	--	--	--	--	--
--	--	--	--	--	--	--	--	--	--	--	--	--	--
--	--	--	--	--	--	--	--	--	--	--	--	--	--
--	--	1	--	--	--	--	--	--	1	--	--	2	5
--	--	--	--	--	--	--	--	--	--	--	--	--	--
--	--	--	--	--	--	--	--	--	--	--	--	--	--
--	--	--	--	--	5	1	1	--	--	--	--	7	8
--	--	--	3	2	1	5	3	2	1	--	1	21	21
--	2	--	1	1	2	2	1	1	1	--	--	31	33
--	2	--	3	3	5	2	3	2	--	--	1	22	25
--	--	--	--	--	--	1	--	--	--	--	--	1	1
4	4	1	9	10	18	5	7	3	4	--	4	78	78
--	--	--	--	--	--	--	--	--	--	--	--	--	--
--	--	--	--	--	--	--	--	--	--	--	--	--	3
7	8	2	22	23	39	23	18	11	9	1	6	204	219
7	8	3	27	28	42	24	21	11	9	3	8	230	250

MARICOPA COUNTY - TOTAL ARRESTS BY AGE

OFFENSE CLASSIFICATION	UNDER 10	10-12	13-14	15	16	17	TOTAL UNDER 18	18	19	20	21
PART I											
Murder/Nonneg. Manslaughter	--	1	4	3	6	10	24	8	4	4	9
Forcible Rape	--	1	6	3	4	5	19	8	7	1	3
Robbery	2	14	79	60	92	119	366	80	60	48	63
Aggravated Assault	17	90	229	166	198	191	891	156	164	140	132
Burglary	27	185	385	309	267	241	1,414	193	135	123	87
Larceny-Theft	72	837	2,146	1,407	1,373	1,306	7,141	1,129	920	795	700
Motor Vehicle Theft	2	37	222	202	234	180	877	124	84	61	52
Arson	5	20	35	14	7	2	83	2	3	2	1
PART I SUBTOTAL	125	1,185	3,106	2,164	2,181	2,054	10,815	1,700	1,377	1,174	1,047
PART II											
Manslaughter by Negligence	--	--	--	--	2	--	2	--	7	1	--
Other Assaults - Simple	32	226	699	472	491	436	2,356	386	454	438	509
Forgery and Counterfeiting	--	5	5	16	31	35	92	56	54	57	45
Fraud	--	6	6	18	23	24	77	40	43	57	42
Embezzlement	--	1	--	3	11	12	27	11	7	4	16
Stolen Property	--	19	134	170	190	194	707	174	122	108	86
Vandalism	60	246	560	341	367	293	1,867	227	137	163	149
Weapons: Carrying, Possessing, Etc.	1	15	88	89	148	199	540	191	186	169	162
Prostitution and Comm. Vice	--	--	2	8	11	15	36	65	87	81	82
Sex Offenses	7	25	59	30	30	28	179	27	39	36	49
DRUGS, SALE OR MFG.											
Opium, Cocaine, Derivatives	--	5	23	14	22	28	92	37	50	66	62
Marijuana	--	4	27	21	40	49	141	32	31	20	21
Synthetic Narcotics	--	--	5	3	5	8	21	5	4	11	4
Other Dangerous Nonnarcotics	--	3	7	6	12	9	37	15	19	24	17
DRUGS, POSSESSION											
Opium, Cocaine, Derivatives	--	--	19	22	33	33	107	63	71	62	75
Marijuana	5	60	397	436	499	497	1,894	518	470	399	323
Synthetic Narcotics	--	1	16	16	16	21	70	32	30	28	28
Other Dangerous Nonnarcotics	--	3	21	25	35	25	109	27	25	25	25
Other Offenses											
All Gambling	--	--	--	--	--	--	--	--	--	--	1
Offenses Against Family/Children	1	1	10	11	16	15	54	22	26	19	13
Driving Under the Influence	4	1	3	12	77	177	274	361	501	610	809
Liquor Law Violations	4	16	302	470	924	1,338	3,054	2,029	1,819	1,469	395
Disorderly Conduct	16	82	337	250	309	309	1,303	355	296	300	369
Vagrancy	--	--	1	1	4	4	10	16	17	13	10
All Other, Except Traffic	27	157	685	655	738	686	2,948	1,328	1,379	1,319	1,334
Curfew/Loitering (Juvenile)	49	305	1,729	1,653	1,644	1,417	6,797	--	--	--	--
Runaways (Juvenile)	8	136	732	625	688	346	2,535	--	--	--	--
PART II SUBTOTAL	214	1,317	5,867	5,367	6,366	6,198	25,329	6,017	5,874	5,479	4,626
TOTAL	339	2,502	8,973	7,531	8,547	8,252	36,144	7,717	7,251	6,653	5,673

MARICOPA COUNTY - TOTAL ARRESTS BY AGE (CONT.)

22	23	24	25-29	30-34	35-39	40-44	45-49	50-54	55-59	60-64	65 AND OVER	TOTAL OVER 18	TOTAL ALL AGES
7	3	7	16	9	5	7	1	3	--	1	2	86	110
2	6	2	29	16	19	8	5	3	--	2	--	111	130
25	38	26	141	120	77	39	15	5	4	1	--	742	1,108
130	114	124	564	528	462	297	164	73	30	27	26	3,131	4,022
76	78	71	359	326	292	165	57	23	8	2	2	1,997	3,411
588	598	611	2,850	2,967	2,653	1,769	880	415	177	120	212	17,384	24,525
45	42	29	157	150	103	45	12	2	--	--	1	907	1,784
1	3	3	5	4	6	3	2	3	2	1	1	42	125
874	882	873	4,121	4,120	3,617	2,333	1,136	527	221	154	244	24,400	35,215
1	1	1	2	5	1	1	--	--	--	--	1	21	23
607	560	524	2,946	2,869	2,291	1,270	615	273	112	52	83	13,989	16,345
48	64	48	205	226	136	82	32	5	5	--	1	1,064	1,156
35	29	42	184	201	171	86	76	31	9	13	5	1,064	1,141
10	6	5	38	25	21	6	8	3	1	--	--	161	188
88	92	85	409	342	219	117	38	30	10	4	1	1,925	2,632
148	131	116	657	642	467	271	124	51	33	9	11	3,336	5,203
143	131	109	394	303	203	132	52	34	19	3	7	2,238	2,778
94	66	99	424	380	324	173	36	17	6	9	10	1,953	1,989
33	33	33	197	228	194	117	86	58	30	27	27	1,214	1,393
58	47	40	194	174	117	70	37	11	6	2	2	973	1,065
19	15	22	88	60	33	34	17	10	3	1	--	406	547
5	8	9	53	39	37	20	8	9	1	--	--	213	234
27	31	37	242	254	178	103	32	12	3	--	3	997	1,034
71	64	76	379	424	365	224	113	37	17	2	--	2,043	2,150
269	242	222	953	671	532	325	138	51	21	5	6	5,145	7,039
28	31	34	203	186	169	69	40	3	1	1	--	883	953
17	22	19	106	132	86	62	18	3	--	--	1	568	677
2	--	--	3	2	2	6	2	3	2	1	--	24	24
16	11	8	58	63	49	23	14	2	4	--	--	328	382
816	885	842	3,943	3,582	2,969	2,045	1,330	756	409	212	230	20,300	20,574
239	251	212	876	849	816	689	405	209	146	61	77	10,542	13,596
349	310	269	1,310	1,201	1,076	645	349	153	67	31	57	7,137	8,440
7	4	6	32	37	56	33	15	7	2	2	4	261	271
1,231	1,210	1,178	5,678	5,644	4,724	2,896	1,523	613	351	166	191	30,765	33,713
--	--	--	--	--	--	--	--	--	--	--	--	--	6,797
--	--	--	--	--	--	--	--	--	--	--	--	--	2,535
4,361	4,244	4,036	19,574	18,539	15,236	9,499	5,108	2,381	1,258	601	717	107,550	132,879
5,235	5,126	4,909	23,695	22,659	18,853	11,832	6,244	2,908	1,479	755	961	131,950	168,094

MOHAVE COUNTY - TOTAL ARRESTS BY AGE

OFFENSE CLASSIFICATION	UNDER 10	10-12	13-14	15	16	17	TOTAL UNDER 18	18	19	20	21
PART I											
Murder/Nonneg. Manslaughter	--	--	1	2	3	--	6	--	--	1	--
Forcible Rape	--	--	--	--	--	--	--	--	--	--	--
Robbery	--	--	--	--	--	--	--	2	1	1	1
Aggravated Assault	3	4	8	11	12	8	46	8	6	6	8
Burglary	13	21	39	44	27	29	173	29	18	9	10
Larceny-Theft	7	77	139	80	91	82	476	67	54	47	36
Motor Vehicle Theft	2	2	9	10	7	5	35	3	--	3	--
Arson	5	11	12	3	1	1	33	--	1	--	--
PART I SUBTOTAL	30	115	208	150	141	125	769	109	80	67	55
PART II											
Manslaughter by Negligence	--	--	--	--	--	--	--	--	--	--	--
Other Assaults - Simple	7	34	69	38	49	27	224	26	20	19	27
Forgery and Counterfeiting	--	--	--	--	2	1	3	3	1	1	1
Fraud	--	--	--	--	1	--	1	6	2	2	1
Embezzlement	--	--	--	--	--	--	--	--	--	--	1
Stolen Property	--	1	5	5	1	6	18	3	2	1	1
Vandalism	9	24	56	29	32	33	183	32	12	9	10
Weapons: Carrying, Possessing, Etc.	--	--	1	3	2	5	11	5	4	2	5
Prostitution and Comm. Vice	--	--	--	--	--	--	--	--	--	--	--
Sex Offenses	--	3	10	2	6	2	23	--	1	3	1
DRUGS, SALE OR MFG.											
Opium, Cocaine, Derivatives	--	--	4	3	9	10	26	19	22	10	7
Marijuana	--	--	--	1	1	5	7	1	1	1	1
Synthetic Narcotics	--	1	4	3	1	1	10	1	1	1	--
Other Dangerous Nonnarcotics	--	--	--	--	2	3	5	1	4	1	4
DRUGS, POSSESSION											
Opium, Cocaine, Derivatives	--	--	--	--	--	--	--	--	--	--	--
Marijuana	--	--	19	11	19	27	76	25	9	15	6
Synthetic Narcotics	1	--	6	4	3	3	17	6	3	4	--
Other Dangerous Nonnarcotics	--	1	3	--	--	1	5	2	3	--	10
All Gambling											
All Gambling	--	--	--	--	--	--	--	--	--	--	--
Offenses Against Family/Children											
Offenses Against Family/Children	1	2	7	4	10	6	30	10	8	10	9
Driving Under the Influence											
Driving Under the Influence	--	--	--	--	5	9	14	11	7	11	13
Liquor Law Violations											
Liquor Law Violations	1	9	49	57	111	184	411	262	263	177	15
Disorderly Conduct											
Disorderly Conduct	6	30	61	30	37	34	198	34	23	31	40
Vagrancy											
Vagrancy	--	1	9	3	--	3	16	--	--	--	--
All Other, Except Traffic											
All Other, Except Traffic	5	39	140	94	94	75	447	94	77	83	89
Curfew/Loitering (Juvenile)											
Curfew/Loitering (Juvenile)	--	6	50	37	31	25	149	--	--	--	--
Runaways (Juvenile)											
Runaways (Juvenile)	2	9	71	65	50	24	221	--	--	--	--
PART II SUBTOTAL	32	160	564	389	466	484	2,095	541	463	381	241
TOTAL	62	275	772	539	607	609	2,864	650	543	448	296

MOHAVE COUNTY - TOTAL ARRESTS BY AGE (CONT.)

22	23	24	25-29	30-34	35-39	40-44	45-49	50-54	55-59	60-64	65 AND OVER	TOTAL OVER 18	TOTAL ALL AGES
1	1	1	4	1	4	2	1	--	--	--	1	17	23
--	--	--	--	2	2	--	--	--	--	--	--	4	4
1	--	--	4	5	5	1	--	--	--	--	--	21	21
6	8	2	40	47	48	28	14	9	8	3	9	250	296
4	7	8	29	20	21	16	4	2	--	1	1	179	352
23	25	29	147	188	161	102	63	28	40	15	29	1,054	1,530
--	2	1	1	6	3	--	1	1	--	--	--	21	56
1	--	--	1	--	--	--	1	--	1	--	--	5	38
36	43	41	226	269	244	149	84	40	49	19	40	1,551	2,320
1	--	--	--	--	--	--	--	--	--	--	--	1	1
25	22	23	119	141	133	96	32	16	17	6	14	736	960
1	1	3	7	7	4	4	1	--	--	--	--	34	37
3	--	2	8	8	14	4	3	--	1	--	2	56	57
--	--	--	--	--	--	--	--	--	--	--	--	1	1
1	1	1	9	6	3	6	2	--	--	--	3	39	57
8	9	12	47	53	30	26	16	4	6	4	3	281	464
6	2	2	12	14	18	3	3	2	1	1	2	82	93
--	--	--	1	1	4	1	--	1	--	--	--	8	8
1	1	1	5	11	9	9	6	7	4	1	1	61	84
7	7	5	12	9	5	6	1	1	--	--	--	111	137
1	1	2	10	5	6	5	1	1	1	--	--	37	44
3	--	4	5	5	5	7	2	1	1	--	--	36	46
2	2	1	13	11	17	4	5	1	--	1	--	67	72
--	--	--	1	--	--	--	2	--	--	--	--	3	3
3	9	5	22	21	33	18	6	1	3	2	--	178	254
1	1	--	9	7	15	6	5	--	--	--	--	57	74
1	--	2	17	10	14	8	6	--	--	--	--	73	78
--	--	--	--	--	--	--	--	--	--	--	--	--	--
8	7	13	94	82	74	36	25	19	8	1	5	409	439
12	14	16	86	94	95	93	60	44	34	17	16	623	637
18	6	12	37	46	57	49	23	19	17	4	8	1,013	1,424
36	29	41	174	173	193	110	73	42	26	13	20	1,058	1,256
1	--	2	2	2	4	1	1	--	1	--	--	14	30
88	74	99	468	440	418	250	127	41	38	21	21	2,428	2,875
--	--	--	--	--	--	--	--	--	--	--	--	--	149
--	--	--	--	--	--	--	--	--	--	--	--	--	221
227	186	246	1,158	1,146	1,151	742	400	200	158	71	95	7,406	9,501
263	229	287	1,384	1,415	1,395	891	484	240	207	90	135	8,957	11,821

NAVAJO COUNTY - TOTAL ARRESTS BY AGE

OFFENSE CLASSIFICATION	UNDER 10	10-12	13-14	15	16	17	TOTAL UNDER 18	18	19	20	21
PART I											
Murder/Nonneg. Manslaughter	--	--	--	--	--	--	--	--	1	--	--
Forcible Rape	--	--	--	--	--	--	--	--	--	--	1
Robbery	--	--	--	--	2	2	4	1	1	--	1
Aggravated Assault	--	4	10	10	8	12	44	9	11	8	7
Burglary	2	7	12	13	7	5	46	4	1	5	2
Larceny-Theft	10	31	69	54	49	33	246	41	30	24	19
Motor Vehicle Theft	--	2	2	6	1	6	17	3	3	2	1
Arson	--	2	2	1	--	--	5	--	--	--	--
PART I SUBTOTAL	12	46	95	84	67	58	362	58	47	39	31
PART II											
Manslaughter by Negligence	--	--	--	--	--	--	--	--	--	--	--
Other Assaults - Simple	--	14	22	14	24	25	99	14	16	31	18
Forgery and Counterfeiting	--	--	--	--	--	1	1	--	1	2	--
Fraud	--	--	--	--	--	--	--	1	--	--	1
Embezzlement	--	--	--	--	--	--	--	--	--	--	--
Stolen Property	--	--	--	--	--	--	--	1	2	--	--
Vandalism	2	1	5	11	8	7	34	9	2	3	6
Weapons: Carrying, Possessing, Etc.	2	1	3	1	2	1	10	--	1	2	--
Prostitution and Comm. Vice	--	--	--	--	--	--	--	--	--	--	--
Sex Offenses	--	--	--	--	--	1	1	1	--	--	--
DRUGS, SALE OR MFG.											
Opium, Cocaine, Derivatives	--	--	--	--	--	--	--	1	1	--	--
Marijuana	1	1	3	1	--	2	8	4	3	1	--
Synthetic Narcotics	--	--	--	--	--	--	--	--	1	--	--
Other Dangerous Nonnarcotics	--	--	--	1	--	--	1	1	--	--	--
DRUGS, POSSESSION											
Opium, Cocaine, Derivatives	--	--	--	--	1	--	1	--	1	1	--
Marijuana	1	1	17	20	16	15	70	40	17	13	8
Synthetic Narcotics	--	--	2	--	--	--	2	--	--	--	--
Other Dangerous Nonnarcotics	--	--	2	--	--	2	4	2	--	--	--
All Gambling	--	--	--	--	--	1	1	--	--	--	--
Offenses Against Family/Children	--	--	--	--	--	--	--	--	--	--	1
Driving Under the Influence	--	--	--	--	3	4	7	11	9	11	15
Liquor Law Violations	1	1	30	41	51	54	178	72	65	32	8
Disorderly Conduct	1	6	42	32	34	31	146	24	22	24	20
Vagrancy	--	--	--	1	1	1	3	1	2	5	6
All Other, Except Traffic	6	16	41	22	53	36	174	56	65	64	43
Curfew/Loitering (Juvenile)	--	1	10	4	3	3	21	--	--	--	--
Runaways (Juvenile)	2	8	41	17	17	17	102	--	--	--	--
PART II SUBTOTAL	16	50	218	165	213	201	863	238	208	189	126
TOTAL	28	96	313	249	280	259	1,225	296	255	228	157

NAVAJO COUNTY - TOTAL ARRESTS BY AGE (CONT.)

22	23	24	25-29	30-34	35-39	40-44	45-49	50-54	55-59	60-64	65 AND OVER	TOTAL OVER 18	TOTAL ALL AGES
--	--	1	--	--	--	--	--	--	--	--	--	2	2
1	--	--	2	1	--	--	--	--	--	--	--	5	5
--	--	--	1	--	1	3	3	1	--	--	--	12	16
3	4	8	25	25	35	16	10	4	2	--	2	169	213
2	1	1	11	6	2	1	--	1	--	--	--	37	83
12	18	12	60	59	59	54	23	21	10	6	6	454	700
--	3	1	5	1	1	--	--	1	--	--	--	21	38
--	--	--	--	--	--	--	--	--	--	--	--	--	5
18	26	23	104	92	98	74	36	28	12	6	8	700	1,062
--	--	--	--	--	--	--	--	--	--	--	--	--	--
17	19	15	82	75	63	69	30	15	4	5	2	475	574
--	--	1	3	--	4	--	--	2	--	--	--	13	14
--	--	--	--	2	1	1	--	1	--	--	--	7	7
--	--	--	--	--	--	--	--	--	--	--	--	--	--
1	1	1	1	5	2	2	--	--	--	--	--	16	16
3	3	2	9	13	13	4	4	1	3	--	--	75	109
2	1	--	3	--	3	1	1	--	--	--	--	14	24
--	--	--	--	--	--	--	--	--	--	--	--	--	--
--	1	--	2	1	1	2	1	1	1	--	1	12	13
1	--	1	2	--	2	--	2	--	--	--	--	10	10
2	--	5	6	8	6	5	1	1	--	--	--	42	50
--	--	2	2	2	1	2	1	--	--	--	--	11	11
--	1	--	1	1	1	--	--	--	--	--	--	5	6
--	1	--	3	3	5	2	3	--	--	--	--	19	20
9	16	12	34	28	18	4	7	6	--	--	--	212	282
1	--	--	1	2	2	1	--	--	--	--	--	7	9
--	1	1	2	5	2	--	--	--	--	--	--	13	17
--	--	--	--	--	--	--	--	--	--	--	--	--	1
--	3	1	5	8	5	7	1	--	2	2	--	35	35
13	22	19	86	83	78	70	32	32	15	5	5	506	513
4	5	--	17	18	10	13	5	6	5	2	1	263	441
17	23	14	91	100	61	49	28	9	10	9	8	509	655
1	6	--	8	14	21	15	8	7	5	5	--	104	107
52	56	55	222	247	228	148	87	49	23	18	9	1,422	1,596
--	--	--	--	--	--	--	--	--	--	--	--	--	21
--	--	--	--	--	--	--	--	--	--	--	--	--	102
123	159	129	580	615	527	395	211	130	68	46	26	3,770	4,633
141	185	152	684	707	625	469	247	158	80	52	34	4,470	5,695

PIMA COUNTY - TOTAL ARRESTS BY AGE

OFFENSE CLASSIFICATION	UNDER	10-12	13-14	15	16	17	TOTAL	18	19	20	21
	10						UNDER 18				
PART I											
Murder/Nonneg. Manslaughter	--	--	2	2	3	7	14	2	12	4	4
Forcible Rape	--	--	4	2	2	4	12	4	1	--	4
Robbery	--	6	12	19	26	21	84	46	27	31	18
Aggravated Assault	11	44	81	41	71	86	334	72	63	35	43
Burglary	15	72	151	96	101	77	512	86	51	39	36
Larceny-Theft	60	359	681	439	414	396	2,349	378	314	213	220
Motor Vehicle Theft	--	19	111	98	132	81	441	66	39	24	25
Arson	18	33	26	9	6	7	99	5	3	--	2
PART I SUBTOTAL	104	533	1,068	706	755	679	3,845	659	510	346	352
PART II											
Manslaughter by Negligence	--	--	--	--	--	--	--	--	1	--	1
Other Assaults - Simple	50	294	498	257	253	198	1,550	180	190	146	213
Forgery and Counterfeiting	--	--	1	5	1	7	14	9	5	6	5
Fraud	--	--	2	2	7	8	19	11	10	7	5
Embezzlement	--	--	--	--	--	--	--	--	--	1	--
Stolen Property	--	--	1	9	5	3	18	15	12	4	5
Vandalism	49	160	262	157	164	139	931	113	76	61	68
Weapons: Carrying, Possessing, Etc.	2	16	47	42	57	60	224	96	60	50	52
Prostitution and Comm. Vice	--	--	--	1	--	4	5	6	9	10	13
Sex Offenses	4	14	44	17	13	9	101	4	11	3	11
DRUGS, SALE OR MFG.											
Opium, Cocaine, Derivatives	--	--	3	5	9	6	23	8	15	10	11
Marijuana	--	5	17	13	11	11	57	7	15	9	9
Synthetic Narcotics	--	--	2	5	5	4	16	10	9	9	5
Other Dangerous Nonnarcotics	--	1	1	1	1	3	7	6	2	--	--
DRUGS, POSSESSION											
Opium, Cocaine, Derivatives	--	--	3	4	5	8	20	18	16	12	14
Marijuana	2	72	244	211	242	264	1,035	302	279	137	126
Synthetic Narcotics	--	--	2	8	11	9	30	27	19	20	12
Other Dangerous Nonnarcotics	1	38	149	134	139	121	582	121	79	74	45
All Gambling	--	1	--	--	4	1	6	1	--	1	--
Offenses Against Family/Children	--	1	8	4	5	2	20	4	3	11	11
Driving Under the Influence	--	--	3	5	24	48	80	112	145	148	211
Liquor Law Violations	2	11	162	245	471	618	1,509	956	866	659	148
Disorderly Conduct	49	213	483	352	314	253	1,664	258	201	172	173
Vagrancy	--	--	2	4	--	--	6	39	20	18	13
All Other, Except Traffic	19	133	333	266	326	319	1,396	447	514	459	506
Curfew/Loitering (Juvenile)	8	104	528	432	447	343	1,862	--	--	--	--
Runaways (Juvenile)	37	320	1,327	929	854	404	3,871	--	--	--	--
PART II SUBTOTAL	223	1,383	4,122	3,108	3,368	2,842	15,046	2,750	2,557	2,027	1,657
TOTAL	327	1,916	5,190	3,814	4,123	3,521	18,891	3,409	3,067	2,373	2,009

PIMA COUNTY - TOTAL ARRESTS BY AGE (CONT.)

22	23	24	25-29	30-34	35-39	40-44	45-49	50-54	55-59	60-64	65 AND OVER	TOTAL OVER 18	TOTAL ALL AGES
5	3	6	18	6	6	6	3	2	1	--	1	79	93
3	2	5	12	12	11	7	6	1	1	--	--	69	81
13	22	9	45	44	18	12	12	1	--	--	--	298	382
36	47	29	161	137	121	93	57	22	5	6	9	936	1,270
30	21	11	99	64	70	34	15	2	3	1	2	564	1,076
154	129	152	686	763	784	620	329	160	81	60	150	5,193	7,542
15	14	22	90	57	58	37	11	4	1	1	1	465	906
--	--	--	7	5	2	6	--	--	--	1	--	31	130
256	238	234	1,118	1,088	1,070	815	433	192	92	69	163	7,635	11,480
--	2	--	1	1	--	2	2	--	--	--	--	10	10
223	231	210	1,106	1,095	931	577	341	141	64	41	53	5,742	7,292
6	5	6	23	15	22	15	8	--	1	1	--	127	141
16	6	9	40	55	43	39	15	8	7	1	2	274	293
1	--	--	1	--	--	--	--	1	--	--	--	4	4
3	4	7	19	22	16	17	3	3	2	--	1	133	151
57	64	67	280	315	226	142	94	38	18	7	16	1,642	2,573
27	26	23	88	50	37	27	13	8	4	2	4	567	791
5	14	6	80	92	80	39	36	19	18	7	20	454	459
9	4	7	42	51	69	48	27	25	11	8	9	339	440
11	18	6	68	39	29	29	7	3	2	--	--	256	279
7	9	11	39	19	25	17	7	4	2	1	--	181	238
6	5	3	28	23	22	14	8	2	1	--	--	145	161
1	2	6	10	5	14	6	3	--	--	--	--	55	62
4	9	12	39	47	38	17	7	3	2	--	--	238	258
102	75	81	293	257	217	118	71	27	10	2	3	2,100	3,135
20	16	16	126	115	108	76	22	5	3	4	--	589	619
48	29	32	214	255	209	146	54	18	2	3	6	1,335	1,917
1	--	--	--	1	1	2	--	--	--	--	--	7	13
7	4	14	44	49	34	15	10	6	1	1	1	215	235
208	247	235	1,021	978	890	639	433	250	165	78	65	5,825	5,905
104	98	62	308	319	498	459	331	198	140	67	75	5,288	6,797
157	142	149	697	682	837	539	339	191	90	65	62	4,754	6,418
19	6	7	35	20	23	21	9	2	3	1	4	240	246
444	487	421	2,081	1,833	1,539	1,015	520	243	122	80	113	10,824	12,220
--	--	--	--	--	--	--	--	--	--	--	--	--	1,862
--	--	--	--	--	--	--	--	--	--	--	--	--	3,871
1,486	1,503	1,390	6,683	6,338	5,908	4,019	2,360	1,195	668	369	434	41,344	56,390
1,742	1,741	1,624	7,801	7,426	6,978	4,834	2,793	1,387	760	438	597	48,979	67,870

PINAL COUNTY - TOTAL ARRESTS BY AGE

OFFENSE CLASSIFICATION	UNDER 10	10-12	13-14	15	16	17	TOTAL UNDER 18	18	19	20	21
PART I											
Murder/Nonneg. Manslaughter	--	--	--	--	--	--	--	--	--	--	1
Forcible Rape	--	--	--	--	--	--	--	--	--	--	1
Robbery	--	2	1	--	5	5	13	7	1	2	1
Aggravated Assault	1	7	20	17	22	17	84	16	8	8	9
Burglary	12	17	83	57	36	35	240	18	14	7	2
Larceny-Theft	20	75	156	101	67	79	498	70	58	28	27
Motor Vehicle Theft	1	1	18	17	6	10	53	2	4	2	1
Arson	4	1	2	1	1	2	11	1	1	--	1
PART I SUBTOTAL	38	103	280	193	137	148	899	114	86	47	43
PART II											
Manslaughter by Negligence	--	--	--	--	--	--	--	--	--	--	--
Other Assaults - Simple	3	32	102	84	72	53	346	45	51	30	32
Forgery and Counterfeiting	--	--	--	--	--	2	2	--	1	--	--
Fraud	--	--	--	--	--	--	--	--	1	--	2
Embezzlement	--	--	--	--	--	--	--	--	--	--	--
Stolen Property	1	--	4	11	8	1	25	2	3	3	1
Vandalism	6	25	77	35	28	22	193	21	20	11	7
Weapons: Carrying, Possessing, Etc.	--	2	10	7	11	12	42	7	4	2	7
Prostitution and Comm. Vice	--	--	1	--	--	--	1	--	--	--	--
Sex Offenses	--	--	2	2	3	2	9	2	3	--	1
DRUGS, SALE OR MFG.											
Opium, Cocaine, Derivatives	--	--	--	--	--	--	--	2	1	1	1
Marijuana	--	--	1	4	5	3	13	3	--	6	3
Synthetic Narcotics	--	--	1	1	--	3	5	2	--	1	2
Other Dangerous Nonnarcotics	--	--	--	--	--	--	--	--	--	--	--
DRUGS, POSSESSION											
Opium, Cocaine, Derivatives	1	1	12	5	10	13	42	15	12	10	6
Manjuana	--	3	22	17	24	21	87	12	18	8	16
Synthetic Narcotics	--	--	2	1	1	3	7	--	1	--	--
Other Dangerous Nonnarcotics	1	--	6	4	5	1	17	--	--	1	2
All Gambling	--	--	--	--	--	--	--	--	--	--	--
Offenses Against Family/Children	--	--	--	--	--	2	2	--	1	--	4
Driving Under the Influence	--	--	--	1	4	1	6	21	7	11	22
Liquor Law Violations	--	6	48	53	78	70	255	85	59	56	15
Disorderly Conduct	6	20	65	45	46	59	241	37	35	37	40
Vagrancy	--	1	4	6	5	5	21	--	--	--	--
All Other, Except Traffic	9	23	91	85	82	66	356	122	135	132	125
Curfew/Loitering (Juvenile)	3	11	60	51	38	25	188	--	--	--	--
Runaways (Juvenile)	1	20	66	54	47	19	207	--	--	--	--
PART II SUBTOTAL	31	144	574	466	467	383	2,065	376	352	309	286
TOTAL	69	247	854	659	604	531	2,964	490	438	356	329

PINAL COUNTY - TOTAL ARRESTS BY AGE (CONT.)

22	23	24	25-29	30-34	35-39	40-44	45-49	50-54	55-59	60-64	65 AND OVER	TOTAL OVER 18	TOTAL ALL AGES
1	1	--	1	1	2	1	--	--	--	--	1	9	9
2	1	--	1	2	1	--	--	--	--	--	--	8	8
1	2	--	6	2	1	1	--	--	2	--	--	26	39
10	6	10	31	39	29	21	6	6	5	1	--	205	289
2	6	2	20	16	7	2	1	1	--	1	--	99	339
19	30	14	104	114	91	62	36	21	17	9	21	721	1,219
1	--	--	11	4	6	2	3	2	1	--	--	39	92
--	--	1	1	1	3	--	--	1	--	--	--	10	21
36	46	27	175	179	140	89	46	31	25	11	22	1,117	2,016
1	--	--	--	--	--	--	--	--	--	--	--	1	1
39	48	50	175	188	145	103	60	24	20	14	10	1,034	1,380
--	--	1	4	1	3	--	1	--	--	--	--	11	13
1	2	--	2	6	5	1	--	1	--	--	--	21	21
--	--	1	--	--	--	--	--	--	--	1	--	2	2
2	--	1	5	6	3	2	--	1	1	--	--	30	55
5	13	13	29	33	17	17	7	9	3	1	5	211	404
3	6	2	16	13	10	8	5	2	1	--	2	88	130
--	--	--	--	--	1	--	--	--	--	--	--	1	2
2	2	--	7	7	6	7	3	1	--	--	2	43	52
1	1	--	3	7	2	3	--	--	--	1	--	23	23
3	--	--	4	4	6	5	1	1	--	--	--	36	49
1	1	2	3	2	6	--	--	--	--	--	--	20	25
--	4	--	3	3	2	--	--	--	--	--	--	12	12
7	8	7	23	18	15	6	3	1	1	--	--	132	174
10	10	9	26	17	22	11	3	1	1	--	--	164	251
1	--	1	3	7	8	3	1	3	--	--	--	28	35
2	1	--	4	2	7	1	1	--	--	--	--	21	38
--	--	--	--	--	--	--	--	--	--	--	--	--	--
3	3	7	3	16	7	5	5	1	--	--	--	55	57
19	9	18	78	88	100	86	66	42	26	15	15	623	629
12	6	6	62	67	29	30	17	8	10	8	2	472	727
39	32	28	154	156	119	68	38	22	14	8	7	834	1,075
--	1	--	--	1	--	--	--	--	--	--	--	2	23
114	123	106	547	549	436	246	144	63	35	14	21	2,912	3,268
--	--	--	--	--	--	--	--	--	--	--	--	--	188
--	--	--	--	--	--	--	--	--	--	--	--	--	207
265	270	252	1,151	1,191	949	602	355	180	112	62	64	6,776	8,841
301	316	279	1,326	1,370	1,089	691	401	211	137	73	86	7,893	10,857

SANTA CRUZ COUNTY - TOTAL ARRESTS BY AGE

OFFENSE CLASSIFICATION	UNDER 10	10-12	13-14	15	16	17	TOTAL UNDER 18	18	19	20	21
PART I											
Murder/Nonneg. Manslaughter	--	--	--	--	--	--	--	--	--	--	--
Forcible Rape	--	--	--	--	--	--	--	--	--	--	--
Robbery	--	--	--	--	1	--	1	1	1	--	--
Aggravated Assault	--	--	5	1	3	7	16	7	11	4	6
Burglary	1	4	5	1	15	17	43	7	7	6	5
Larceny-Theft	--	5	14	6	13	13	51	7	11	4	6
Motor Vehicle Theft	--	--	--	--	--	--	--	1	1	1	--
Arson	--	--	--	--	--	--	--	--	--	--	--
PART I SUBTOTAL	1	9	24	8	32	37	111	23	31	15	17
PART II											
Manslaughter by Negligence	--	--	--	--	--	--	--	--	--	--	--
Other Assaults - Simple	--	1	12	5	4	5	27	4	6	7	2
Forgery and Counterfeiting	--	--	--	--	--	--	--	--	--	--	--
Fraud	--	--	--	--	--	--	--	--	--	--	--
Embezzlement	--	--	--	--	--	--	--	--	--	--	--
Stolen Property	--	--	--	1	2	7	10	2	--	--	--
Vandalism	--	--	2	--	--	--	2	1	2	--	--
Weapons: Carrying, Possessing, Etc.	--	--	1	3	--	1	5	1	1	2	2
Prostitution and Comm. Vice	--	--	--	--	--	--	--	--	--	--	--
Sex Offenses	--	--	1	1	--	--	2	--	--	--	--
DRUGS, SALE OR MFG.											
Opium, Cocaine, Derivatives	--	--	--	--	--	--	--	--	--	--	--
Marijuana	--	--	--	--	--	--	--	--	--	--	--
Synthetic Narcotics	--	--	--	--	--	--	--	--	--	--	--
Other Dangerous Nonnarcotics	--	--	--	--	--	--	--	--	--	--	--
DRUGS, POSSESSION											
Opium, Cocaine, Derivatives	--	--	1	--	1	--	2	--	1	1	--
Marijuana	--	3	5	8	12	16	44	8	8	8	8
Synthetic Narcotics	--	--	--	--	--	--	--	--	--	--	--
Other Dangerous Nonnarcotics	--	--	--	1	1	1	3	--	--	--	--
All Gambling	--	--	--	--	--	--	--	--	--	--	--
Offenses Against Family/Children	--	--	--	--	--	--	--	--	--	--	--
Driving Under the Influence	--	--	--	--	--	--	--	1	3	4	2
Liquor Law Violations	--	--	--	1	1	2	4	--	2	1	--
Disorderly Conduct	--	4	4	5	5	9	27	2	4	3	2
Vagrancy	--	--	--	--	--	--	--	--	--	--	--
All Other, Except Traffic	--	9	20	14	25	15	83	16	17	13	21
Curfew/Loitering (Juvenile)	--	--	--	--	--	--	--	--	--	--	--
Runaways (Juvenile)	--	--	1	3	--	1	5	--	--	--	--
PART II SUBTOTAL	--	17	47	42	51	57	214	35	44	39	37
TOTAL	1	26	71	50	83	94	325	58	75	54	54

SANTA CRUZ COUNTY - TOTAL ARRESTS BY AGE (CONT.)

22	23	24	25-29	30-34	35-39	40-44	45-49	50-54	55-59	60-64	65 AND OVER	TOTAL OVER 18	TOTAL ALL AGES
--	--	--	--	--	--	--	--	--	--	--	--	--	--
--	--	--	--	--	--	--	--	--	--	--	--	--	--
--	--	1	--	1	1	--	--	--	--	--	--	5	6
9	6	2	17	10	15	2	6	4	1	2	--	102	118
3	1	2	3	1	2	3	1	--	--	--	--	41	84
6	4	5	25	10	15	10	8	2	3	1	--	117	168
2	--	--	2	2	1	--	--	--	--	--	--	10	10
--	--	--	--	--	--	--	--	--	--	--	--	--	--
20	11	10	47	24	34	15	15	6	4	3	--	275	386
--	--	--	--	--	--	--	--	--	--	--	--	--	--
3	4	4	26	19	11	7	8	4	1	--	--	106	133
--	--	--	--	--	--	--	--	--	--	--	--	--	--
--	--	--	--	--	--	--	--	--	--	--	--	--	--
--	1	1	1	2	--	--	1	--	--	--	--	8	18
--	--	--	1	--	1	--	--	--	--	--	--	5	7
1	--	--	--	--	1	--	--	--	--	--	--	8	13
--	--	--	--	--	--	--	--	--	--	--	--	--	--
--	--	--	--	--	--	1	--	--	--	--	--	1	3
--	--	--	--	--	--	--	--	--	--	--	--	--	--
--	--	--	--	--	--	--	--	--	--	--	--	--	--
--	--	--	--	--	--	--	--	--	--	--	--	--	--
--	--	2	--	--	1	1	--	--	--	--	--	6	8
7	8	5	14	5	4	5	--	1	--	1	--	82	126
--	--	--	--	--	--	--	--	--	--	--	--	--	--
--	1	--	--	--	1	--	--	--	--	--	--	2	5
--	--	--	--	--	--	--	--	--	--	--	--	--	--
--	--	--	--	--	1	--	--	--	--	--	--	1	1
6	7	2	9	13	7	19	6	5	1	3	1	89	89
--	--	--	--	--	1	--	--	--	--	--	--	4	8
6	3	4	13	13	14	10	13	4	2	--	--	93	120
--	--	--	--	--	--	--	--	--	--	--	--	--	--
21	16	18	77	51	60	41	22	13	2	--	1	389	472
--	--	--	--	--	--	--	--	--	--	--	--	--	--
--	--	--	--	--	--	--	--	--	--	--	--	--	5
44	40	36	141	103	102	84	50	27	6	4	2	794	1,008
64	51	46	188	127	136	99	65	33	10	7	2	1,069	1,394

YAVAPAI COUNTY - TOTAL ARRESTS BY AGE

OFFENSE CLASSIFICATION	UNDER 10	10-12	13-14	15	16	17	TOTAL UNDER 18	18	19	20	21
PART I											
Murder/Nonneg. Manslaughter	--	--	--	--	--	--	--	--	1	1	--
Forcible Rape	--	1	--	--	1	--	2	1	1	--	--
Robbery	--	--	--	--	--	2	2	4	--	--	1
Aggravated Assault	2	4	11	9	12	7	45	11	6	6	12
Burglary	5	38	33	24	34	22	156	27	17	11	15
Larceny-Theft	14	44	145	68	93	78	442	83	50	38	26
Motor Vehicle Theft	2	7	26	19	12	7	73	5	5	3	2
Arson	5	9	8	1	--	2	25	--	1	--	2
PART I SUBTOTAL	28	103	223	121	152	118	745	131	81	59	58
PART II											
Manslaughter by Negligence	--	--	--	--	--	--	--	--	--	--	--
Other Assaults - Simple	1	21	32	35	28	18	135	31	15	17	20
Forgery and Counterfeiting	--	--	--	--	3	5	8	5	3	5	4
Fraud	--	--	1	--	2	4	7	2	3	2	5
Embezzlement	--	--	--	--	--	--	--	--	--	--	--
Stolen Property	2	2	5	3	6	7	25	3	3	--	--
Vandalism	18	23	35	20	30	18	144	13	15	7	7
Weapons: Carrying, Possessing, Etc.	--	2	3	6	5	4	20	4	3	3	9
Prostitution and Comm. Vice	--	--	--	--	--	--	--	--	--	--	--
Sex Offenses	--	1	3	2	--	--	6	3	1	3	1
DRUGS, SALE OR MFG.											
Opium, Cocaine, Derivatives	--	--	2	8	12	11	33	2	1	3	2
Marijuana	--	2	11	4	5	4	26	19	9	12	16
Synthetic Narcotics	--	2	7	1	1	--	11	4	1	6	4
Other Dangerous Nonnarcotics	--	--	--	--	--	--	--	8	2	8	3
DRUGS, POSSESSION											
Opium, Cocaine, Derivatives	--	--	--	1	--	1	2	1	1	3	1
Marijuana	--	6	24	14	21	24	89	21	18	30	18
Synthetic Narcotics	--	--	--	--	2	1	3	5	1	--	--
Other Dangerous Nonnarcotics	--	--	3	--	--	1	4	1	--	--	--
All Gambling											
Offenses Against Family/Children	--	1	9	3	3	1	17	5	3	2	1
Driving Under the Influence	--	1	3	--	2	8	14	9	19	16	32
Liquor Law Violations	--	5	35	33	98	86	257	120	100	77	9
Disorderly Conduct	3	20	32	25	22	20	122	18	11	9	17
Vagrancy	--	--	--	--	--	--	--	--	--	--	--
All Other, Except Traffic	11	21	109	75	71	100	387	104	141	129	140
Curfew/Loitering (Juvenile)	--	3	24	23	13	9	72	--	--	--	--
Runaways (Juvenile)	1	32	87	81	47	27	275	--	--	--	--
PART II SUBTOTAL	36	142	425	334	371	349	1,657	378	350	332	289
TOTAL	64	245	648	455	523	467	2,402	509	431	391	347

YAVAPAI COUNTY - TOTAL ARRESTS BY AGE (CONT.)

22	23	24	25-29	30-34	35-39	40-44	45-49	50-54	55-59	60-64	65 AND OVER	TOTAL OVER 18	TOTAL ALL AGES
2	--	--	--	4	1	--	--	--	1	--	1	11	11
2	--	--	--	--	1	--	--	--	--	2	1	8	10
--	1	--	--	1	2	1	4	--	--	--	--	14	16
9	9	17	36	39	35	33	22	11	3	5	1	255	300
2	--	7	20	8	9	12	6	3	3	2	--	142	298
18	14	22	90	94	120	66	58	32	9	10	27	757	1,199
--	1	--	6	3	4	--	4	--	--	--	1	34	107
--	1	--	--	2	2	2	--	1	--	--	--	11	36
33	26	46	152	151	174	114	94	47	16	19	31	1,232	1,977
--	--	--	1	1	--	--	--	--	--	--	--	2	2
25	22	26	124	117	118	99	65	8	10	9	10	716	851
--	1	3	10	9	7	2	3	--	--	--	--	52	60
6	2	3	28	35	32	27	8	7	1	1	2	164	171
--	--	--	--	--	--	--	--	--	--	--	--	--	--
--	2	--	2	3	2	--	--	--	--	--	1	16	41
7	7	8	44	35	38	17	14	15	2	2	3	234	378
2	5	5	11	6	9	10	3	1	1	--	--	72	92
--	--	--	--	--	1	--	--	1	--	--	--	2	2
3	--	2	12	8	8	3	8	4	1	--	6	63	69
3	1	1	2	4	6	4	1	1	--	--	--	31	64
10	6	5	34	35	34	26	12	2	1	--	--	221	247
6	--	2	19	18	14	12	6	1	1	--	--	94	105
4	2	2	24	15	22	14	6	1	--	--	1	112	112
4	1	--	3	2	2	10	1	1	--	--	--	30	32
13	12	12	62	42	33	32	12	6	--	--	--	311	400
--	--	--	4	1	5	1	--	--	--	--	--	17	20
2	1	--	2	4	3	4	1	--	--	--	--	18	22
--	--	--	--	--	--	--	--	--	--	--	1	1	1
4	1	2	29	26	36	20	8	5	1	--	2	145	162
29	35	36	181	207	231	188	146	71	34	25	27	1,286	1,300
6	6	6	19	23	30	42	19	11	3	2	2	475	732
20	26	14	88	106	101	71	48	23	7	3	11	573	695
3	--	--	--	2	--	--	3	1	--	--	--	9	9
116	125	106	555	492	420	263	197	100	27	18	28	2,961	3,348
--	--	--	--	--	--	--	--	--	--	--	--	--	72
--	--	--	--	--	--	--	--	--	--	--	--	--	275
263	255	233	1,254	1,191	1,152	845	561	259	89	60	94	7,605	9,262
296	281	279	1,406	1,342	1,326	959	655	306	105	79	125	8,837	11,239

YUMA COUNTY - TOTAL ARRESTS BY AGE

OFFENSE CLASSIFICATION	UNDER 10	10-12	13-14	15	16	17	TOTAL UNDER 18	18	19	20	21
PART I											
Murder/Nonneg. Manslaughter	--	--	--	--	--	--	--	--	--	--	--
Forcible Rape	--	--	--	--	--	--	--	1	--	--	--
Robbery	--	--	2	--	5	1	8	4	1	1	2
Aggravated Assault	1	4	17	6	10	12	50	5	8	4	6
Burglary	--	11	22	18	2	13	66	15	15	5	4
Larceny-Theft	9	32	93	48	42	40	264	34	37	23	24
Motor Vehicle Theft	--	2	5	5	2	5	19	1	1	2	1
Arson	2	4	1	--	--	--	7	1	1	--	--
PART I SUBTOTAL	12	53	140	77	61	71	414	61	63	35	37
PART II											
Manslaughter by Negligence	--	--	--	--	--	--	--	--	--	--	--
Other Assaults - Simple	1	8	55	29	44	31	168	20	28	21	22
Forgery and Counterfeiting	--	--	--	--	--	1	1	3	3	2	5
Fraud	--	--	--	--	3	--	3	1	--	--	--
Embezzlement	--	--	--	--	--	--	--	--	--	1	--
Stolen Property	--	--	--	--	--	--	--	--	--	--	--
Vandalism	6	11	42	52	19	22	152	18	14	8	11
Weapons: Carrying, Possessing, Etc.	--	--	4	3	2	3	12	5	6	1	5
Prostitution and Comm. Vice	--	--	--	--	--	--	--	--	--	--	--
Sex Offenses	--	2	3	1	1	1	8	1	2	2	1
DRUGS, SALE OR MFG.											
Opium, Cocaine, Derivatives	--	--	--	--	--	--	--	--	--	--	--
Marijuana	--	2	9	8	3	4	26	--	1	3	1
Synthetic Narcotics	--	--	--	--	--	--	--	--	--	--	--
Other Dangerous Nonnarcotics	--	--	--	--	--	--	--	--	1	--	--
DRUGS, POSSESSION											
Opium, Cocaine, Derivatives	--	--	--	--	--	--	--	1	--	--	--
Marijuana	1	8	24	24	29	32	118	23	18	20	7
Synthetic Narcotics	--	1	5	5	7	1	19	3	--	--	1
Other Dangerous Nonnarcotics	--	--	3	2	4	--	9	2	1	1	1
All Gambling	--	--	--	--	--	--	--	--	--	--	--
Offenses Against Family/Children	--	--	--	1	--	--	1	7	6	4	4
Driving Under the Influence	1	--	--	1	3	7	12	10	12	11	19
Liquor Law Violations	--	3	8	33	46	57	147	51	59	43	9
Disorderly Conduct	3	15	33	28	21	29	129	28	13	15	15
Vagrancy	--	--	3	--	--	--	3	--	2	2	--
All Other, Except Traffic	--	8	40	36	44	44	172	39	73	63	59
Curfew/Loitering (Juvenile)	--	6	12	36	18	18	90	--	--	--	--
Runaways (Juvenile)	--	13	124	97	63	28	325	--	--	--	--
PART II SUBTOTAL	12	77	365	356	307	278	1,395	212	239	197	160
TOTAL	24	130	505	433	368	349	1,809	273	302	232	197

YUMA COUNTY - TOTAL ARRESTS BY AGE (CONT.)

22	23	24	25-29	30-34	35-39	40-44	45-49	50-54	55-59	60-64	65 AND OVER	TOTAL OVER 18	TOTAL ALL AGES
--	--	--	1	--	1	--	--	--	--	--	--	2	2
--	--	--	1	--	2	--	--	--	--	--	--	4	4
1	--	--	3	--	4	--	--	--	--	--	--	16	24
8	7	7	29	21	10	8	8	2	2	--	1	126	176
5	2	3	20	13	5	4	2	1	1	--	--	95	161
16	19	25	121	119	93	55	51	23	5	14	14	673	937
2	1	2	6	10	6	3	1	--	--	--	1	37	56
--	--	--	1	--	--	1	1	--	--	--	--	5	12
32	29	37	182	163	121	71	63	26	8	14	16	958	1,372
--	--	--	--	--	--	--	--	--	--	--	--	--	--
21	24	12	102	97	66	53	23	17	11	4	5	526	694
4	3	2	16	13	14	9	2	1	1	1	--	79	80
--	--	--	2	4	2	1	--	--	--	--	--	10	13
--	1	--	--	--	--	1	--	--	--	--	--	3	3
--	--	--	--	--	--	--	1	--	--	--	--	1	1
7	4	10	25	14	11	14	8	5	--	5	2	156	308
2	1	1	5	6	7	4	2	1	--	--	--	46	58
--	--	--	1	1	1	--	--	--	--	1	--	4	4
--	1	2	6	6	3	5	6	1	--	5	1	42	50
--	--	--	2	5	2	2	1	1	--	--	--	13	13
1	1	--	3	3	--	2	--	--	--	--	--	15	41
--	--	--	1	--	--	--	--	--	--	--	--	1	1
--	--	--	2	--	1	--	--	--	--	--	--	4	4
--	1	--	4	7	4	2	6	--	1	--	--	26	26
7	11	9	39	22	15	13	2	1	2	--	1	190	308
--	--	--	--	1	--	--	1	--	--	--	--	6	25
1	1	2	9	20	6	1	1	--	--	--	--	46	55
--	--	--	--	--	--	--	--	--	--	--	--	--	--
6	3	3	16	19	7	6	1	--	--	--	--	82	83
14	18	20	75	69	74	61	45	27	18	14	7	494	506
2	6	4	43	61	67	82	69	33	25	29	36	619	766
16	13	10	84	68	55	42	45	14	13	11	11	453	582
--	1	--	7	15	11	9	12	3	3	3	1	69	72
44	36	40	185	211	166	144	76	58	21	31	35	1,281	1,453
--	--	--	--	--	--	--	--	--	--	--	--	--	90
--	--	--	--	--	--	--	--	--	--	--	--	--	325
125	125	115	627	642	512	451	301	162	95	104	99	4,166	5,561
157	154	152	809	805	633	522	364	188	103	118	115	5,124	6,933

POLICE DISPOSITION OF JUVENILES

COUNTY	TOTAL	Handled within Department and Released	Referred to Juvenile Court or Prob. Dept.	Referred to Welfare Agency	Referred to Other Police Agency	Referred to Criminal or Adult Court
Apache	499	34	464	--	1	--
Cochise	1,768	220	1,540	1	5	2
Coconino	2,365	25	2,334	4	1	1
Gila	1,107	175	928	--	4	--
Graham	621	50	571	--	--	--
Greenlee	125	--	125	--	--	--
La Paz	20	1	18	1	--	--
Maricopa	36,584	2,495	31,615	10	459	2,005
Mohave	2,864	--	2,864	--	--	--
Navajo	1,233	107	1,101	--	--	25
Pima	18,903	919	17,381	41	8	554
Pinal	2,964	141	2,791	--	6	26
Santa Cruz	325	8	317	--	--	--
Yavapai	2,516	212	2,297	--	1	6
Yuma	1,811	533	1,239	--	13	26
TOTAL	73,705	4,920	65,585	57	498	2,645

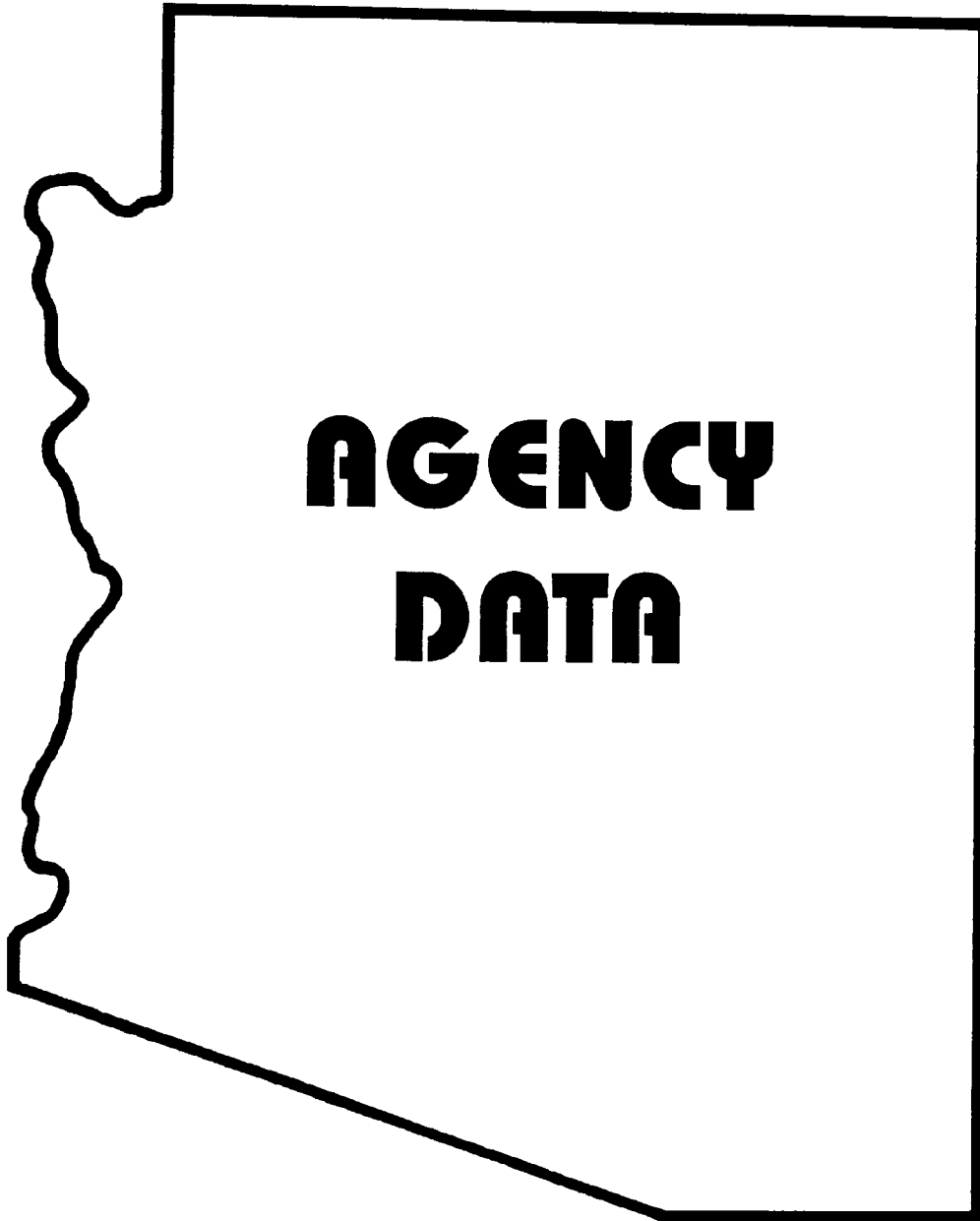

AGENCY DATA

AGENCY	Months on File	Crime Index Total	Violent Crime Total	Murder	Rape	Robbery	Aggravated Assault
Apache County SO	12	250	45	1	3	1	40
Apache Junction PD	12	1,335	116	--	3	14	99
AZ Dept. of Public Safety	12	32	15	--	--	--	15
AZ State Capitol PD	12	195	8	--	--	7	1
AZ State University PD	12	1,637	51	--	3	10	38
AZ State University West PD	12	44	--	--	--	--	--
AZ Western College PD	12	80	4	--	--	--	4
Avondale PD	8	1,240	100	1	5	19	75
Benson PD	12	277	6	1	1	1	3
Bishee PD	12	354	18	--	--	1	17
Buckeye PD	12	191	12	--	--	--	12
Bullhead City PD	12	2,509	203	3	2	34	164
Camp Verde MO	12	187	16	--	--	--	16
Casa Grande PD	12	2,964	258	2	17	32	207
Central AZ College PD	12	97	2	--	1	--	1
Chandler PD	12	8,627	428	2	29	143	254
Chino Valley PD	12	213	18	--	--	--	18
Clarkdale PD	12	72	5	1	--	--	4
Clifton PD	0	--	--	--	--	--	--
Cochise County SO	12	1,336	129	1	2	11	115
Coconino County SO	12	742	76	3	19	--	54
Colorado City MO	0	--	--	--	--	--	--

AGENCY DATA (CONT.)

Property Crime Total	Burglary	Larceny	Motor Vehicle Theft	Arson	Employee Data				Estimated Population
					Sworn Male	Sworn Female	Total Civilians	Total Employees	
205	76	120	9	--	28	1	29	58	54,590
1,219	269	837	104	9	42	4	22	68	21,260
17	--	17	--	--	899	65	692	1,656	--
187	17	146	21	3	27	1	32	60	--
1,586	632	907	45	2	30	5	22	57	--
44	13	30	1	--	8	--	9	17	--
76	8	65	3	--	7	--	1	8	--
1,140	274	763	100	3	38	3	12	53	24,370
271	36	224	9	2	11	--	7	18	4,195
336	46	268	22	--	15	1	6	22	6,510
179	38	121	18	2	12	3	7	22	4,905
2,306	587	1,499	198	22	65	3	36	104	27,370
171	48	113	8	2	14	2	9	25	7,760
2,706	386	2,084	222	14	46	4	24	74	21,300
95	13	81	1	--	6	--	--	6	--
8,199	1,796	5,210	1,116	77	185	8	68	261	141,735
195	58	128	8	1	12	1	8	21	6,660
67	40	23	3	1	8	--	--	8	2,690
--	--	--	--	--	7	--	5	12	3,000
1,207	477	587	137	6	60	3	105	168	43,995
666	197	446	19	4	55	7	67	129	45,385
--	--	--	--	--	4	--	1	5	3,525

AGENCY DATA

AGENCY	Months on File	Crime Index Total	Violent Crime Total	Murder	Rape	Robbery	Aggravated Assault
Coolidge PD	12	677	72	--	13	7	52
Cottonwood PD	12	762	29	--	1	2	26
Douglas PD	0	--	--	--	--	--	--
Eagar PD	12	175	14	1	3	--	10
El Mirage PD	12	349	28	2	2	--	24
Eloy PD	12	1,106	95	1	6	13	75
Flagstaff PD	12	5,257	318	1	10	65	242
Florence PD	12	276	37	--	--	1	36
Fountain Hills MO*	0	--	--	--	--	--	--
Fredonia MO	0	--	--	--	--	--	--
Gila County SO	12	747	62	--	5	1	56
Gilbert PD	12	3,022	222	1	11	43	167
Glendale PD	12	13,558	1,221	11	51	301	858
Globe PD	12	642	109	--	1	4	104
Goodyear PD	12	715	36	1	1	5	29
Graham County SO	12	168	15	--	1	--	14
Greenlee County SO	12	66	5	--	--	--	5
Hayden PD	12	38	5	--	--	--	5
Holbrook PD	12	504	29	--	7	3	19
Huachuca City PD	12	58	8	--	--	2	6
Jerome PD	12	21	3	--	--	--	3
Kearny PD	12	86	3	--	--	--	3

AGENCY DATA (CONT.)

Property Crime Total	Burglary	Larceny	Motor Vehicle Theft	Arson	Employee Data				Estimated Population
					Sworn Male	Sworn Female	Total Civilians	Total Employees	
605	173	381	50	1	16	3	6	25	7,140
733	107	599	19	8	20	--	13	33	6,675
--	--	--	--	--	33	1	13	47	14,885
161	31	116	14	--	7	--	2	9	4,600
321	127	163	24	7	12	2	4	18	5,765
1,011	361	611	32	7	19	2	10	31	9,045
4,939	575	4,161	177	26	72	4	36	112	55,885
239	47	184	8	--	11	3	6	20	11,540
--	--	--	--	--	6	--	2	8	15,220
--	--	--	--	--	2	--	1	3	1,295
685	173	464	45	3	52	2	65	119	23,500
2,800	782	1,740	263	15	67	12	31	110	67,440
12,337	2,277	7,883	2,099	78	220	24	96	340	186,695
533	114	389	26	4	26	2	8	36	7,270
679	213	426	38	2	26	2	7	35	10,215
153	12	128	10	3	13	2	17	32	16,060
61	--	61	--	--	15	--	11	26	5,650
33	15	15	--	3	6	--	2	8	910
475	51	400	23	1	16	2	5	23	5,385
50	18	26	6	--	4	--	5	9	1,985
18	4	12	2	--	3	--	--	3	560
83	18	63	2	--	6	2	4	12	2,475

AGENCY DATA

AGENCY	Months on File	Crime Index Total	Violent Crime Total	Murder	Rape	Robbery	Aggravated Assault
Kingman PD	12	1,749	146	1	8	13	124
La Paz County SO	2	54	12	--	--	1	11
Lake Havasu City PD	12	1,726	67	1	2	11	53
Mammoth PD	12	73	11	--	1	--	10
Marana PD	12	886	45	4	2	9	30
Maricopa County SO	12	6,385	515	22	24	75	394
Mesa PD	12	25,862	2,459	18	110	506	1,825
Miami PD	12	97	13	--	--	--	13
Mohave County SO	12	2,098	120	5	5	15	95
Navajo County SO	12	545	68	--	5	--	63
Nogales PD	12	1,184	153	1	1	37	114
Northern AZ University PD	12	531	18	--	2	2	14
Oro Valley PD	10	273	9	--	--	--	9
Page PD	6	392	26	--	3	--	23
Paradise Valley PD	12	573	8	--	1	1	6
Parker PD	12	195	24	--	--	4	20
Patagonia MO	0	--	--	--	--	--	--
Payson PD	12	602	20	--	4	4	12
Peoria PD	12	3,421	157	3	14	42	98
Phoenix PD	12	109,028	10,529	186	460	3,757	6,126
Pima College PD	12	160	1	--	--	--	1
Pima County SO	12	12,236	915	22	85	189	619

AGENCY DATA (CONT.)

Property Crime Total	Burglary	Larceny	Motor Vehicle Theft	Arson	Employee Data				Estimated Population
					Sworn Male	Sworn Female	Total Civilians	Total Employees	
1,603	390	1,128	72	13	33	6	18	57	17,385
42	7	23	11	1	38	2	48	88	13,180
1,659	278	1,257	114	10	55	3	21	79	37,580
62	20	37	5	--	5	1	--	6	1,980
841	84	717	39	1	34	3	10	47	5,960
5,870	1,241	3,843	775	11	444	30	1,532	2,006	204,915
23,403	3,883	15,582	3,811	127	550	64	311	925	343,710
84	28	55	1	--	7	1	3	11	2,045
1,978	825	988	139	26	83	6	129	218	41,840
477	183	249	35	10	45	7	52	104	50,600
1,031	315	490	218	8	56	1	17	74	20,765
513	57	446	4	6	12	5	12	29	--
264	28	210	20	6	43	4	18	65	21,405
366	97	257	10	2	16	3	11	30	8,205
565	314	209	39	3	30	--	9	39	12,785
171	47	112	12	--	11	1	4	16	2,965
--	--	--	--	--	5	--	--	5	950
582	56	505	21	--	22	2	9	33	11,575
3,264	808	2,156	286	14	72	13	34	119	78,310
98,499	19,559	60,565	18,096	279	2,001	254	885	3,140	1,180,740
159	34	108	17	--	24	5	7	36	--
11,321	2,075	7,558	1,611	77	341	54	686	1,081	295,925

AGENCY DATA

AGENCY	Months on File	Crime Index Total	Violent Crime Total	Murder	Rape	Robbery	Aggravated Assault
Pima PD	12	82	10	--	--	--	10
Pinal County SO	12	1,887	227	6	23	19	179
Pinetop-Lakeside PD	12	241	35	2	--	6	27
Prescott PD	12	2,016	114	--	19	15	80
Prescott Valley PD	12	782	51	--	7	4	40
Quartzsite MO	12	145	10	--	--	1	9
Safford PD	12	257	22	--	--	--	22
St. Johns PD	10	110	2	--	--	--	2
San Luis PD	12	391	14	2	--	2	10
Santa Cruz County SO	12	338	70	--	2	--	68
Scottsdale PD	12	9,790	445	8	23	133	281
Sedona PD	12	464	10	--	3	1	6
Show Low PD	12	592	52	--	--	4	48
Sierra Vista PD	12	1,421	47	--	3	13	31
Snowflake-Taylor PD	12	264	56	--	1	--	55
Somerton PD	12	223	15	--	--	3	12
South Tucson PD	12	1,165	226	3	8	68	147
Springerville PD	12	109	6	1	--	--	5
Superior PD	12	251	29	--	--	3	26
Surprise PD	12	491	4	--	--	2	2
Tempe PD	12	14,083	871	3	35	321	512
Thatcher PD	12	282	9	--	--	1	8

AGENCY DATA (CONT.)

Property Crime Total	Burglary	Larceny	Motor Vehicle Theft	Arson	Employee Data				Estimated Population
					Sworn Male	Sworn Female	Total Civilians	Total Employees	
72	15	55	2	--	2	--	--	2	1,970
1,660	543	923	193	1	123	12	191	326	65,925
206	37	156	7	6	15	1	8	24	3,340
1,902	214	1,603	69	16	50	4	29	83	31,275
731	125	574	31	1	27	1	10	38	16,860
135	64	63	8	--	5	--	1	6	2,055
235	36	191	7	1	16	1	3	20	9,095
108	30	71	7	--	8	--	1	9	3,360
377	50	287	40	--	17	1	6	24	8,800
268	108	128	32	--	31	2	24	57	13,335
9,345	1,786	6,455	1,051	53	245	25	138	408	178,525
454	102	339	11	2	17	1	8	26	9,235
540	86	422	28	4	20	1	11	32	7,230
1,374	167	1,062	142	3	39	2	19	60	38,310
208	57	141	10	--	11	--	2	13	6,940
208	38	163	6	1	13	1	5	19	6,125
939	189	646	104	--	20	2	10	32	5,570
103	14	87	2	--	6	--	1	7	1,925
222	65	145	12	--	8	1	4	13	3,485
487	136	323	28	--	23	2	2	27	11,335
13,212	2,047	9,169	1,944	52	235	28	120	383	156,000
273	25	244	3	1	9	--	1	10	4,025

AGENCY DATA

AGENCY	Months on File	Crime Index Total	Violent Crime Total	Murder	Rape	Robbery	Aggravated Assault
Tolleson PD	12	356	36	1	4	3	28
Tombstone MO	8	76	25	--	--	1	24
Tucson PD	12	46,667	5,199	46	282	1,288	3,583
University of AZ PD	12	1,125	10	--	--	3	7
Wellton MO	12	26	3	--	--	--	3
Wickenburg PD	12	218	17	--	3	2	12
Willcox PD	12	364	15	--	1	3	11
Williams PD	0	--	--	--	--	--	--
Winslow PD	12	1,023	75	--	4	15	56
Yavapai College PD	12	48	2	--	2	--	--
Yavapai County SO	12	2,516	348	4	12	7	325
Youngtown PD	12	112	8	--	2	3	3
Yuma County SO	12	1,155	107	--	4	7	96
Yuma PD**	8	3,008	319	2	21	46	250

AGENCY DATA (CONT.)

Property Crime Total	Burglary	Larceny	Motor Vehicle Theft	Arson	Employee Data				Estimated Population
					Sworn Male	Sworn Female	Total Civilians	Total Employees	
320	74	217	29	--	10	4	7	21	4,400
51	4	43	3	1	5	1	1	7	1,435
41,468	6,710	28,460	6,016	282	696	117	258	1,071	449,635
1,115	157	902	46	10	41	5	32	78	--
23	5	17	1	--	4	--	--	4	1,165
201	40	147	12	2	9	--	6	15	4,845
349	68	261	20	--	9	--	5	14	3,610
--	--	--	--	--	10	--	6	16	2,705
948	181	732	30	5	21	2	9	32	10,805
46	2	43	--	1	2	2	2	6	--
2,168	719	1,292	146	11	83	5	112	200	52,685
104	23	68	13	--	8	1	6	15	2,715
1,048	397	575	76	--	47	4	159	210	45,710
2,689	495	1,915	259	20	101	14	53	168	63,150

* Agency statistics are included with Maricopa County Sheriff's Office.

** Agency was unable to provide complete data prior to deadline.

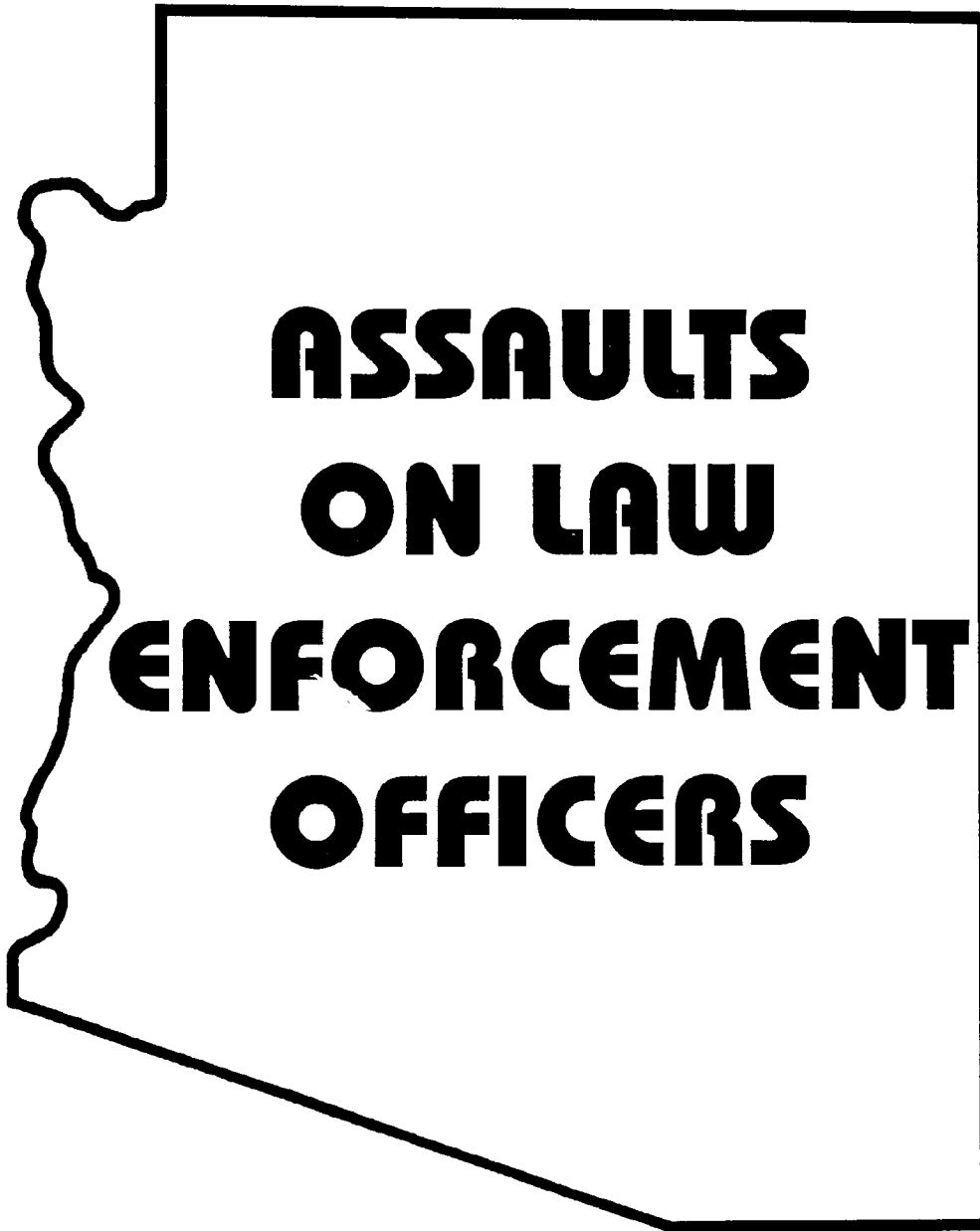

POLICE OFFICER ASSAULTS

DEFINITION

All assaults on sworn officers resulting in serious injury or in which a weapon was used that could have caused serious injury or death. Also included are assaults not causing injury which involved more than mere verbal abuse or minor resistance to arrest.

SUMMARY

- There were a total of 1,807 police officers assaulted statewide in 1996.
- Personal weapons, such as hands, fists, and feet, were used in 1,484 assaults, or 82.1 percent.
- The time period of 10:01 PM to midnight recorded the highest incidence of assaults with 328, or 18.2 percent.
- The highest number of assaults, 585, or 32.4 percent, occurred when officers were responding to disturbance calls.
- Personal injuries were sustained in 285 assaults, or 15.8 percent.

CLEARANCES

- There were 1,728 clearances for assaults on police officers reported in 1996. This represents a clearance rate of 95.6 percent

INJURY VS. NONINJURY

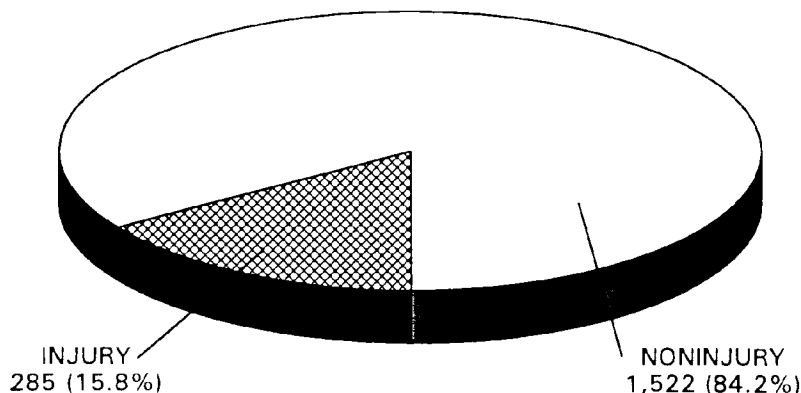

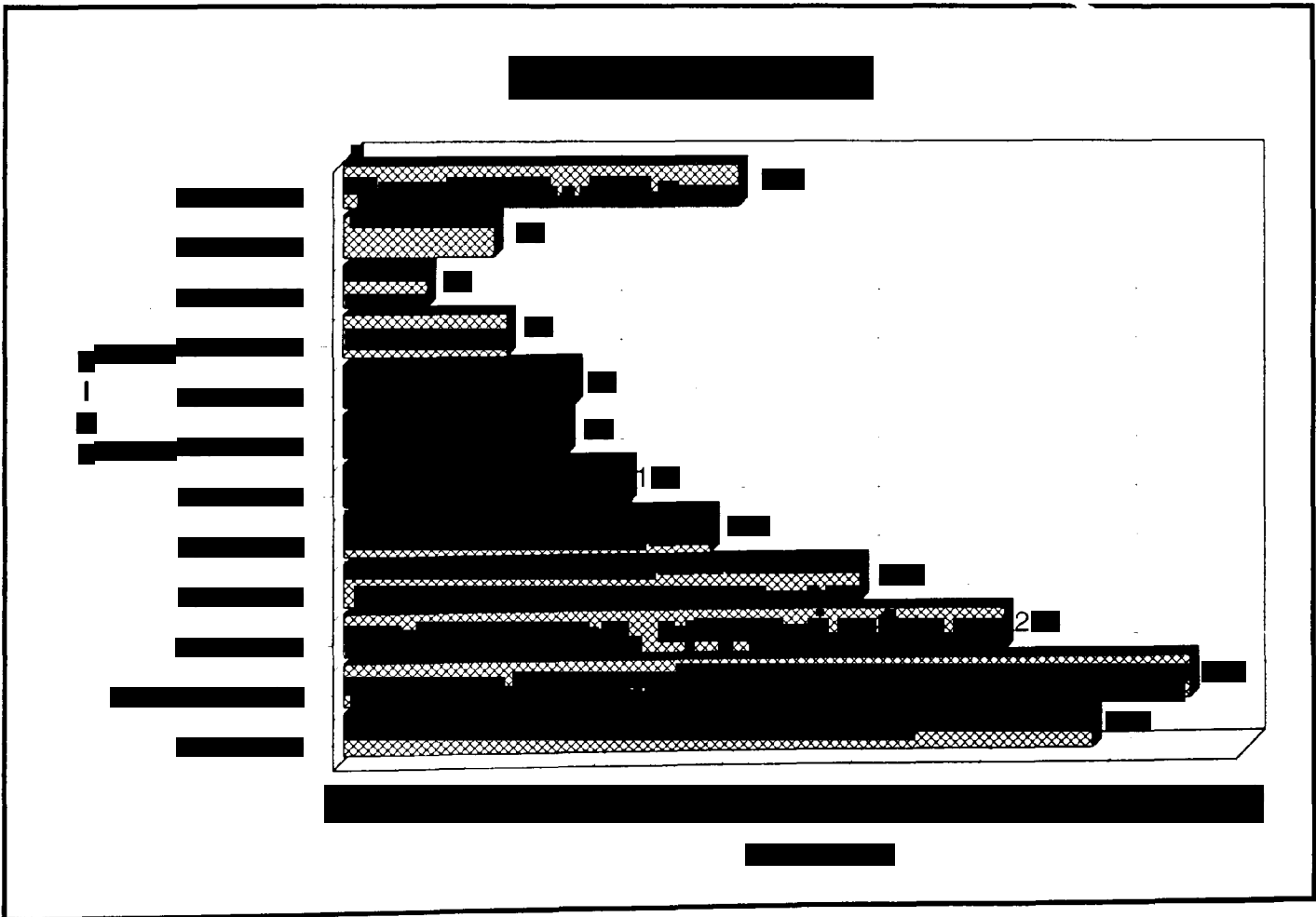
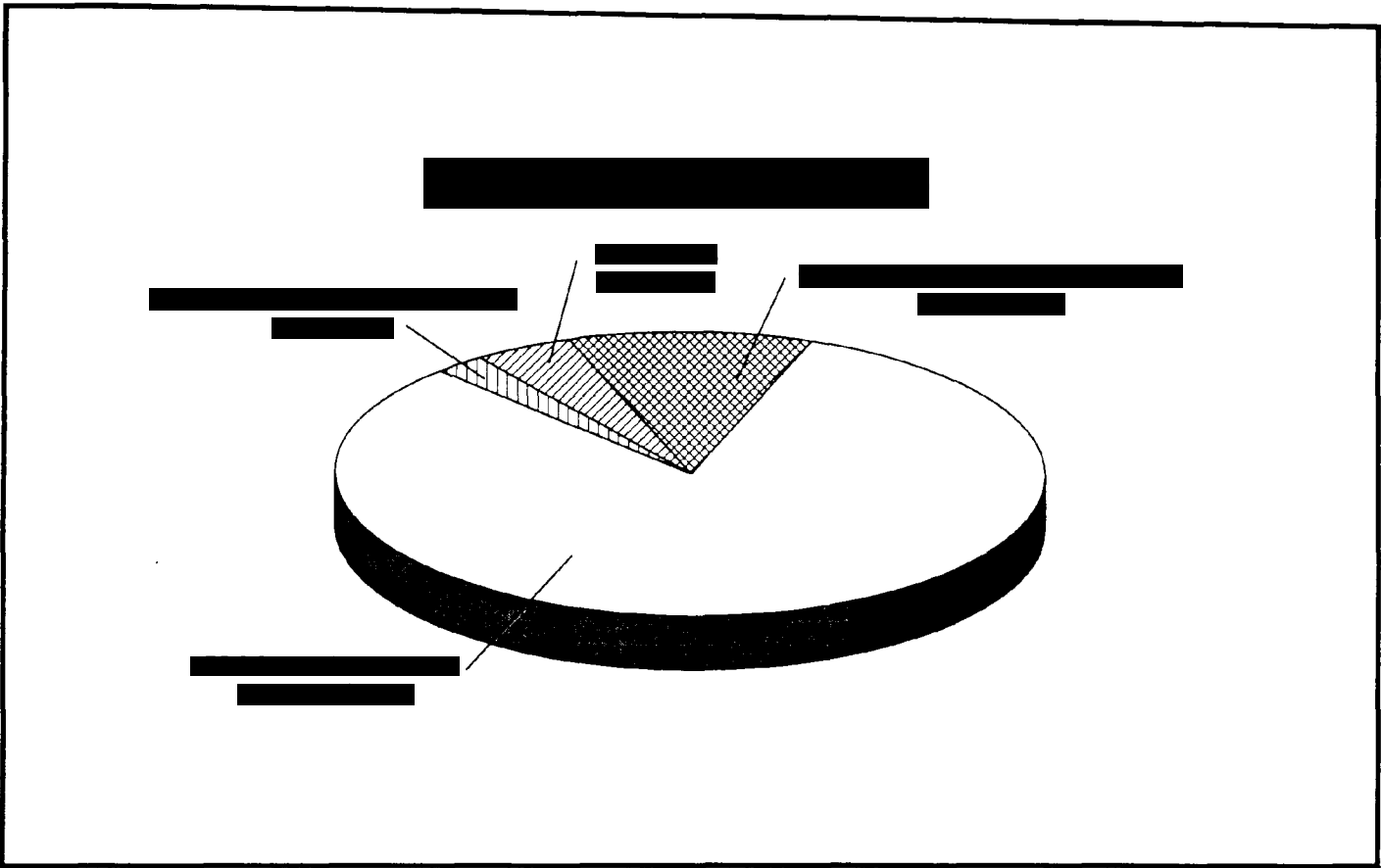

OFFICERS ASSAULTED FREQUENCY DISTRIBUTION

TYPE OF ACTIVITY	TOTAL ASSAULTS BY WEAPON	TYPE OF WEAPON				TYPE OF ASSIGNMENT						POLICE ASSAULTS CLEARED	
		FIREARM	KNIFE OR OTHER CUTTING INSTRUMENT	OTHER DANGEROUS WEAPON	HANDS, FISTS, FEET, ETC.	TWO-MAN VEHICLE	ONE-MAN VEHICLE		DETECTIVE OR SPECIAL ASSIGNMENT		OTHER		
							ALONE	ASSISTED	ALONE	ASSISTED	ALONE		ASSISTED
Responding to "disturbance" calls	585	33	30	49	473	99	90	354	2	10	6	24	560
Burglaries in progress or pursuing burglary suspects	39	7	2	8	22	2	8	25	--	3	1	--	37
Robberies in progress or pursuing robbery suspects	8	3	--	2	3	--	3	5	--	--	--	--	8
Attempting other arrests	295	9	2	24	260	23	50	185	--	13	9	15	289
Civil disorder (Riot, mass disobedience)	14	--	--	--	14	--	1	5	--	--	--	8	14
Handling or transporting of prisoners	253	--	--	12	241	22	47	164	--	6	3	11	251
Investigating suspicious persons or circumstances	132	6	2	19	105	17	43	53	--	7	2	10	121
Ambush - No warning	2	2	--	--	--	--	--	--	--	--	--	2	2
Mentally deranged	35	4	2	3	26	9	6	20	--	--	--	--	29
Traffic pursuits and stops	159	--	2	34	123	24	34	84	3	12	1	1	151
All Other	285	19	3	46	217	38	54	116	9	25	20	23	266
TOTAL	1,807	83	43	197	1,484	234	336	1,011	14	76	42	94	1,728
Number with personal injury	285	5	4	44	232								
Number without personal injury	1,522	78	39	153	1,252								

OFFICER ASSAULTED DISTRIBUTION BY COUNTY

COUNTY	NUMBER OF ASSAULTS	WITH INJURY	WITHOUT INJURY	PERCENT DISTRIBUTION	CLEARANCE
Apache	1	--	1	0.1%	1
Cochise	14	3	11	0.8%	14
Coconino	8	4	4	0.4%	6
Gila	17	3	14	0.9%	16
Graham	--	--	--	--	--
Greenlee	--	--	--	--	--
La Paz	2	1	1	0.1%	2
Maricopa	1,219	122	1,097	67.5%	1,162
Mohave	19	4	15	1.0%	16
Navajo	22	4	18	1.2%	21
Pima	424	112	312	23.5%	413
Pinal	9	2	7	0.5%	9
Santa Cruz	5	--	5	0.3%	5
Yavapai	38	12	26	2.1%	35
Yuma	29	18	11	1.6%	28
TOTAL	1,807	285	1,522	100.0%	1,728



**BIAS
CRIMES
DATA**

BIAS (HATE) CRIME DATA COLLECTION

BACKGROUND

The collection of bias (hate) crime statistics is the latest addition to the Uniform Crime Reporting program. It reflects a growing concern on both a federal and state level to the problem of crimes being committed due to bias or hate.

The collection of these statistics began with the passage of Public Law 101-275, known as the Hate Crime Statistics Act, in April 1990. The Act required the Attorney General to establish guidelines and collect data "about crimes that manifest evidence of prejudice based on race, religion, sexual orientation, or ethnicity, including where appropriate the crimes of murder, non-negligent manslaughter; forcible rape; aggravated assault, simple assault, intimidation; arson; and destruction, damage or vandalism of property."

In Arizona, legislation mandating the collection of bias (hate) crime statistics was passed in 1991. Arizona Revised Statutes 41-1750 was amended in part to read that the criminal identification section within the Department of Public Safety shall "Collect information concerning criminal offenses that manifest evidence of prejudice based on race, color, religion, national origin, sexual orientation, gender or disability."

Statewide collection began January 1992. Statistics received from Arizona law enforcement agencies for 1996 are listed on the following pages.

BIAS OFFENSES - FIVE YEAR COMPARISON

OFFENSE	1992	1993	1994	1995	1996
Homicide	--	--	1	--	--
Forcible Rape	1	--	--	--	3
Robbery	--	3	7	8	2
Aggravated Assault	38	45	38	42	33
Simple Assault	49	50	29	47	53
Burglary	2	3	6	8	6
Larceny-Theft	--	--	--	1	--
Motor Vehicle Theft	--	--	--	--	1
Arson	--	1	4	1	2
Intimidation	66	55	66	66	87
Destruction/Damage/Vandalism	23	59	64	57	70
TOTAL	179	216	215	230	257

BIAS (HATE) CRIMES

DEFINITION

A bias (hate) crime is defined as a criminal offense committed against a person or property which is motivated, in whole or in part, by the offender's bias against a race, religion, ethnic/national origin group, sexual orientation group, disability, or gender.

SUMMARY

- There were 251 actual incidents of bias crimes reported in 1996 involving 257 offenses.
- Intimidation accounted for 87 offenses, or 33.9 percent, followed by vandalism with 70 offenses and simple assault with 53 offenses.
- The residence/home accounted for the most frequent location of occurrence of bias offenses with 102 or 39.7 percent.
- Racial bias accounted for 152 of all bias offenses, or 59.1 percent, followed by sexual and religious bias with 36 offenses, or 14.0 percent each, and ethnic origin bias with 32 offenses, or 12.5 percent. There was 1 offense of disability bias reported in 1996.
- The most frequently reported known suspected offenders' race was white, reported in 133 incidents, or 53.0 percent, followed by black with 18, American Indian with 2, Asian/Pacific Islander with 2, and multi-racial group with 12. In 84 bias incidents, the suspected offenders' race was reported as unknown.

BIAS OFFENSES BY QUARTER - 1996

OFFENSE	1ST	2ND	3RD	4TH	TOTAL
Homicide	--	--	--	--	--
Forcible Rape	--	1	--	2	3
Robbery	--	--	--	2	2
Aggravated Assault	10	8	10	5	33
Simple Assault	12	15	10	16	53
Burglary	1	4	1	--	6
Larceny-Theft	--	--	--	--	--
Motor Vehicle Theft	--	1	--	--	1
Arson	--	1	--	1	2
Intimidation	25	22	28	12	87
Destruction/Damage/Vandalism	22	21	14	13	70
TOTAL	70	73	63	51	257

BIAS OFFENSE LOCATIONS BY QUARTER - 1996

LOCATION	1ST	2ND	3RD	4TH	TOTAL
Air/Bus/Train Terminal	--	--	--	--	--
Bank/Savings and Loan	--	--	--	--	--
Bar/Night Club	1	4	2	3	10
Church/Synagogue/Temple	3	3	2	2	10
Commercial/Office Building	5	3	1	2	11
Construction Site	--	--	2	1	3
Convenience Store	2	--	--	1	3
Department/Discount Store	1	--	--	--	1
Drug Store/Doctor's Office/Hospital	--	--	--	--	--
Field/Woods	--	--	--	--	--
Government/Public Building	4	1	2	--	7
Grocery/Supermarket	1	--	--	--	1
Highway/Road/Alley/Street	17	8	10	12	47
Hotel/Motel/Etc.	--	3	--	1	4
Jail/Prison	--	--	--	--	--
Lake/Waterway	--	--	--	--	--
Liquor Store	--	--	--	--	--
Parking Lot/Garage	4	9	6	3	22
Rental Storage Facility	--	--	--	--	--
Residence/Home	25	25	33	19	102
Restaurant	--	3	3	1	7
School/College	5	11	--	5	21
Service/Gas Station	1	1	2	1	5
Specialty Store	--	--	--	--	--
Other/Unknown	1	2	--	--	3
TOTAL	70	73	63	51	257

BIAS MOTIVATION BY QUARTER - 1996

TYPE OF BIAS	1ST	2ND	3RD	4TH	TOTAL
RACIAL					
Anti-White	7	5	5	6	23
Anti-Black	29	29	30	25	113
Anti-American Indian/Alaskan Native	--	--	2	--	2
Anti-Asian/Pacific Islander	2	2	1	--	5
Anti-Multi-Racial Group	3	4	1	1	9
ETHNIC/NATIONAL ORIGIN					
Anti-Arab	--	2	--	--	2
Anti-Hispanic	5	11	7	3	26
Anti-Other Ethnic/National Origin	--	--	2	2	4
RELIGIOUS					
Anti-Jewish	10	6	8	7	31
Anti-Catholic	--	--	--	--	--
Anti-Protestant	--	--	--	1	1
Anti-Islamic	--	--	--	--	--
Anti-Other Religion	1	2	1	--	4
Anti-Multi-Religious Group	--	--	--	--	--
Anti-Atheism/Agnosticism/Etc.	--	--	--	--	--
SEXUAL					
Anti-Male Homosexual	12	7	5	5	29
Anti-Female Homosexual	--	3	1	1	5
Anti-Homosexual	1	1	--	--	2
Anti-Heterosexual	--	--	--	--	--
Anti-Bisexual	--	--	--	--	--
DISABILITY					
Anti-Mental	--	--	--	--	--
Anti-Physical	--	1	--	--	1
GENDER					
Anti-Female	--	--	--	--	--
Anti-Male	--	--	--	--	--
TOTAL	70	73	63	51	257

BIAS OFFENSES BY COUNTY - 1996

COUNTY	1ST	2ND	3RD	4TH	TOTAL
Apache	--	2	--	--	2
Cochise	--	--	2	--	2
Coconino	--	1	--	2	3
Gila	--	--	--	--	--
Graham	--	--	--	--	--
Greenlee	--	--	--	--	--
La Paz	--	--	--	--	--
Maricopa	57	59	48	39	203
Mohave	1	1	3	--	5
Navajo	3	--	--	--	3
Pima	9	10	10	8	37
Pinal	--	--	--	--	--
Santa Cruz	--	--	--	--	--
Yavapai	--	--	--	2	2
Yuma	--	--	--	--	--
TOTAL	70	73	63	51	257

BIAS OFFENSES BY AGENCY - 1996

AGENCY	1ST	2ND	3RD	4TH	TOTAL
Apache County SO	--	--	--	--	--
Apache Junction PD	--	--	--	--	--
AZ Dept of Public Safety	--	1	--	--	1
AZ State Capitol PD	--	--	--	--	--
AZ State University PD	--	--	--	--	--
AZ State University West PD	--	--	--	--	--
AZ Western College PD	--	--	--	--	--
Avondale PD	--	--	--	--	--
Benson PD	--	--	--	--	--
Bisbee PD	--	--	2	--	2
Buckeye PD	--	--	--	--	--
Bullhead City PD	--	--	--	--	--
Camp Verde MO	--	--	--	--	--
Casa Grande PD	--	--	--	--	--
Central AZ College PD	--	--	--	--	--
Chandler PD	1	2	2	4	9
Chino Valley PD	--	--	--	--	--
Clarkdale PD	--	--	--	--	--
Clifton PD	--	--	--	--	--
Cochise County SO	--	--	--	--	--
Coconino County SO	--	--	--	--	--
Colorado City MO	--	--	--	--	--
Coolidge PD	--	--	--	--	--
Cottonwood PD	--	--	--	--	--
Douglas PD	--	--	--	--	--
Eagar PD	--	--	--	--	--
El Mirage PD	--	--	--	--	--
Eloy PD	--	--	--	--	--
Flagstaff PD	--	--	--	2	2
Florence PD	--	--	--	--	--

BIAS OFFENSES BY AGENCY- 1996 (CONT.)

AGENCY	1ST	2ND	3RD	4TH	TOTAL
Fountain Hills MO	--	--	--	--	--
Fredonia MO	--	--	--	--	--
Gila County SO	--	--	--	--	--
Gilbert PD	--	--	--	1	1
Glendale PD	4	2	1	1	8
Globe PD	--	--	--	--	--
Goodyear PD	--	--	--	--	--
Graham County SO	--	--	--	--	--
Greenlee County SO	--	--	--	--	--
Hayden PD	--	--	--	--	--
Holbrook PD	--	--	--	--	--
Huachuca City PD	--	--	--	--	--
Jerome PD	--	--	--	--	--
Kearny PD	--	--	--	--	--
Kingman PD	--	--	--	--	--
La Paz County SO	--	--	--	--	--
Lake Havasu City PD	1	1	2	--	4
Mammoth PD	--	--	--	--	--
Marana PD	--	--	--	--	--
Maricopa County SO	--	--	--	--	--
Mesa PD	10	6	9	2	27
Miami PD	--	--	--	--	--
Mohave County SO	--	--	1	--	1
Navajo County SO	--	--	--	--	--
Nogales PD	--	--	--	--	--
Northern AZ University PD	--	1	--	--	1
Oro Valley PD	--	--	--	--	--
Page PD	--	--	--	--	--
Paradise Valley PD	--	--	--	--	--
Parker PD	--	--	--	--	--

BIAS OFFENSES BY AGENCY - 1996 (CONT.)

AGENCY	1ST	2ND	3RD	4TH	TOTAL
Patagonia MO	--	--	--	--	--
Payson PD	--	--	--	--	--
Peoria PD	--	--	--	1	1
Phoenix PD	35	41	35	24	135
Pima College PD	--	--	--	--	--
Pima County SO	9	7	9	8	33
Pima PD	--	--	--	--	--
Pinal County SO	--	--	--	--	--
Pinetop-Lakeside PD	--	--	--	--	--
Prescott PD	--	--	--	2	2
Prescott Valley PD	--	--	--	--	--
Quartzsite MO	--	--	--	--	--
Safford PD	--	--	--	--	--
St. Johns PD	--	2	--	--	2
San Luis PD	--	--	--	--	--
Santa Cruz County SO	--	--	--	--	--
Scottsdale PD	4	1	1	2	8
Sedona PD	--	--	--	--	--
Show Low PD	3	--	--	--	3
Sierra Vista PD	--	--	--	--	--
Snowflake-Taylor PD	--	--	--	--	--
Somerton PD	--	--	--	--	--
South Tucson PD	--	--	--	--	--
Springerville PD	--	--	--	--	--
Superior PD	--	--	--	--	--
Surprise PD	--	--	--	--	--
Tempe PD	3	6	--	4	13
Thatcher PD	--	--	--	--	--
Tolleson PD	--	--	--	--	--
Tombstone MO	--	--	--	--	--

BIAS OFFENSES BY AGENCY - 1996 (CONT.)

AGENCY	1ST	2ND	3RD	4TH	TOTAL
Tucson PD	--	3	1	--	4
University of AZ PD	--	--	--	--	--
Wellton MO	--	--	--	--	--
Wickenburg PD	--	--	--	--	--
Willcox PD	--	--	--	--	--
Williams PD	--	--	--	--	--
Winslow PD	--	--	--	--	--
Yavapai College PD	--	--	--	--	--
Yavapai County SO	--	--	--	--	--
Yuma County SO	--	--	--	--	--
Yuma PD	--	--	--	--	--

GLOSSARY

Adult - For UCR purposes, a person 18 years or older.

American Indian or Alaskan Native - A person having origins in any of the original peoples of North America, and who maintains cultural identification through tribal affiliation or community recognition.

Asian or Pacific Islander - A person having origins in any of the original peoples of the Far East, Southeast Asia, the Indian subcontinent, or the Pacific Islands. This area includes for example: China, India, Japan, Korea, the Philippine Islands, and Samoa.

Black - A person having origins in any of the black racial groups of Africa, characterized by dark skin pigmentation.

Classifying - Determining the correct UCR part I or Part II offense category based on police information.

Cleared by Arrest - An offense that is cleared (solved) when at least one person is (1) arrested, (2) charged with the commission of the offense, and (3) turned over to the court for prosecution.

Cleared by Exceptional Means - For UCR purposes, an offense is considered exceptionally cleared when law enforcement has: (1) definitely established the identity of the offender, (2) there is enough information to support an arrest, charge, and turning over to the court for prosecution, (3) the exact location of the offender is known so the subject could be taken into custody, and yet (4) some reason outside law enforcement control prevents bringing the offender to court.

Crimes Against Persons - Includes the following Index offenses: Murder, rape, and aggravated assault.

Crimes Against Property - Includes the following Index offenses: Burglary, larceny-theft, motor vehicle theft, and arson.

Crime Index - The total of eight offenses used to measure the extent, fluctuation and distribution of crime in a given geographical area. The Crime Index includes: Murder, rape, robbery, aggravated assault, burglary, larceny-theft, motor vehicle theft, and arson.

Hierarchy Rule - A standard UCR scoring practice used in multiple offense situations in which only the most serious offense (as determined by the established Crime Index order) is counted.

Hispanic - A person of Mexican, Cuban, Central or South American, or other Spanish culture or origin, regardless of race.

Hotel Rule - A standard UCR scoring practice which limits to one the number of burglaries which can be counted when more than one room is entered for the purpose of committing a felony or theft within a structure generally intended to house a transient population.

Incident Base Reporting - A less restrictive and more expansive method of collecting crime data (as opposed to Summary Reporting) in which all the data elements associated with an offense or arrest are compiled on an incident by incident basis.

Justifiable Homicide - The killing of a felon (while the subject is in the act of committing a felony) by a private citizen or a peace officer in the line of duty.

Juvenile - For UCR purposes, any person under the age of 18.

Juvenile Clearance - Offenses involving only persons under the age of 18 that are cleared by arrest or exceptional means.

Part I Offenses - The first of two main groupings of UCR crime classifications consisting of the eight Index crimes plus manslaughter by negligence.

GLOSSARY (CONT.)

Part II Offenses - The second of two main groupings of crime classifications consisting of all other crime categories not already designated as Part I, excluding traffic violations. With the exception of simple assault, the monthly reporting of Part II offenses is limited to arrest information only in the Summary Reporting System.

Property Crime - Any of the following Index offenses: Burglary, larceny-theft, motor vehicle theft, and arson.

Scoring - Counting the number of offenses committed after the police report has been classified.

Summary Reporting - A method of collecting crime data adopted for national reporting purposes in which a limited amount of data associated with an offense or arrest is compiled by each contributing agency.

Unfounded Offense - A record of complaint which is found to be false or baseless after police investigation. The number of these complaints received are not included in the number of actual offenses used in tabulating the crime index, crime rate, etc.

Violent Crime - Any of the following Index offenses: Murder, rape, robbery, and aggravated assault.

White - A person having origins in any of the original peoples of Europe, North Africa or the Middle East.



Arizona Department of Public Safety

2102 W. Encanto Blvd., P. O. Box 6638
Phoenix, Arizona 85005
Phone: (602) 223 - 2000