

87.7
154
195

1995

CRIME

IN

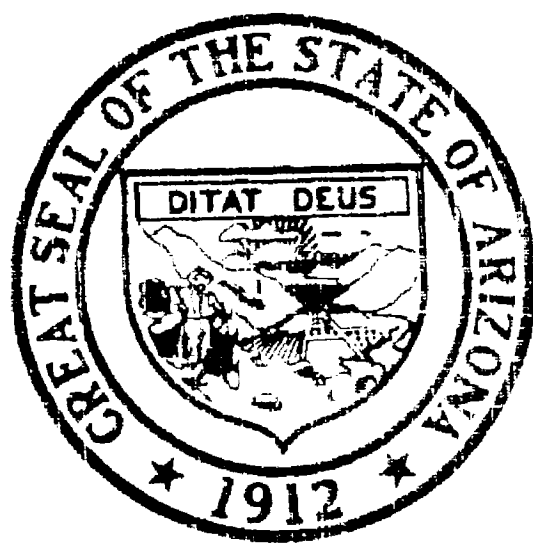

ARIZONA

CRIME IN ARIZONA 1995

*An annual report compiled by
the Arizona Department of Public Safety*

Joe Albo
Director
Arizona Department of Public Safety



Arizona Department of Public Safety, 2102 West Encanto Boulevard, P. O. Box 6638, Phoenix, Arizona 85005-6638

81 423RSU
XL 3474
11/98 30-010-02 GBC

ARIZONA DEPARTMENT OF PUBLIC SAFETY

2102 WEST ENCANTO BLVD. P. O. BOX 6638 PHOENIX, ARIZONA 85005-6638 (602) 223-2000



FIFE SYMINGTON
GOVERNOR

JOE ALBO
DIRECTOR

FOREWORD

The Arizona Department of Public Safety is pleased to participate in and serve as the coordinating agency for the Arizona Crime Reporting Program.

The purpose of the 1995 "Crime in Arizona" report is to provide data regarding the nature and extent of crime throughout the state. This report does not draw conclusions as to the causes of crime. The report does provide the vital information necessary to assist law enforcement agencies, government, and the public in their approach to crime in our state.

This report is the culmination of a joint effort by our state's law enforcement agencies to collect and organize crime data. The information contained in this report should provide a valuable overview of the crime problem.

This is the fourth year that data concerning the nature and extent of bias (hate) crimes has been included. Again, this information does not draw conclusions as to the causes of crimes committed due to bias but it is an additional resource that can be utilized by the citizens of Arizona.

Sincere appreciation is expressed to all Arizona law enforcement agencies without whose cooperation this publication would not be possible.

JOE ALBO
Director

TABLE OF CONTENTS

DEDICATION	1
ACKNOWLEDGEMENT	2
THE ARIZONA UNIFORM CRIME REPORTING SYSTEM	4
SUMMARY OF STATE CRIME DATA	
Arizona Crime Clock	8
Arizona Crime Cycle	9
State Crime Summary	10
Total Index Crimes by Month	12
Index Crimes Cleared	12
Index Crime Comparison	13
Value of Property Loss by Index Crime Offense	14
Type and Value of Property Stolen and Recovered	14
PART I INDEX CRIMES	
Murder	17
Definition and Summary	17
Murder by Month	18
Murder by Day of Week	18
Murder by Time of Day	19
Murder Distribution by Circumstance	19
Murder by Type of Weapon Used	20
Murder Distribution by Relationship	20
Murder Victim by Age, Sex, Race and Ethnic Origin	21
Rape	22
Definition and Summary	22
Rape by Month	23
Robbery	24
Definition and Summary	24
Robbery by Location and Value	25
Robbery by Month and Weapon Used	25
Aggravated Assault	26
Definition and Summary	26
Assault by Weapon Used	27
Assault by Month	27
Burglary	28
Definition and Summary	28
Burglary by Location and Time	29
Burglary by Month and Means of Entry	29
Larceny-Theft	30
Definition and Summary	30
Larceny-Theft by Type by Month	31
Larceny-Theft by Value by Month	31
Larceny-Theft by Classification and Value	32
Additional Analysis	32
Motor Vehicle Theft	33
Definition and Summary	33
Motor Vehicle Theft by Month	34
Stolen Vehicle by Type	34

TABLE OF CONTENTS

Arson	35
Definition and Summary	35
Arson by Property Classification	36
Value of Property Damaged	36
Arson Offenses by Property Type by Month	37
COUNTY OFFENSE AND SUPPLEMENTAL DATA	
Index Crimes	40
Analysis of Robbery, Burglary, and Larceny-Theft	42
Value, in Dollar, of Property Stolen by Crime	44
Type and Value, in Dollars, of Property Stolen and Recovered	46
STATE ARREST DATA	
Summary	50
Arrests by Age Group	50
Total Arrests by Offense, Race and Ethnic Origin	51
Juvenile Arrests by Offense, Race and Ethnic Origin	52
Adult Arrests by Offense, Race and Ethnic Origin	53
Total Arrests by Age	54
Juvenile Male Arrests	56
Juvenile Female Arrests	57
Adult Male Arrests	58
Adult Female Arrests	60
COUNTY ARREST DATA	
Apache County	64
Cochise County	66
Coconino County	68
Gila County	70
Graham County	72
Greenlee County	74
La Paz County	76
Maricopa County	78
Mohave County	80
Navajo County	82
Pima County	84
Pinal County	86
Santa Cruz County	88
Yavapai County	90
Yuma County	92
Police Disposition of Juveniles	94
ASSAULTS ON LAW ENFORCEMENT OFFICERS	
Definition and Summary	96
Injury vs. Noninjury	96
Weapons Used	97
Time of Day	97
Officers Assaulted Frequency Distribution	97
Officers Assaulted Distribution by County	98
Officers Assaulted Distribution by County	99

TABLE OF CONTENTS

BIAS CRIMES DATA

Background	102
Four Year Comparison	102
Definition and Summary	103
Offenses by Quarter for 1995	103
Offenses by Location	104
Offenses by Motivation	105
Offenses by County	106
Offenses by Agency	107

FULL-TIME LAW ENFORCEMENT EMPLOYEES

Definition	110
Distribution of Employees	110
Number of Employees by Agency	111

GLOSSARY

.....	113
-------	-----

**This publication is dedicated to those Arizona Law Enforcement
Officers who gave their lives in the line of duty during 1995.**

Sergeant Michael L. Crowe
Arizona Department of Public Safety
July 4, 1995

Lieutenant Dan Elkins
Yuma Police Department
July 4, 1995

Officer Robert K. Martin
Arizona Department of Public Safety
August 15, 1995

Deputy Edwardo M. Gonzales
Maricopa County Sheriff's Office
August 28, 1995

Deputy Ken Blair
Maricopa County Sheriff's Office
September 28, 1995

Officer Ronald Kelley
Ak-Chin Tribal Police Department
November 20, 1995

Acknowledgement

Appreciation is expressed to the agencies listed below. The monthly Uniform Crime Reporting (UCR) information submitted by these agencies served as the basis for this publication.

Apache County Sheriff's Office
Apache Junction Police Department
Arizona Department of Public Safety
AZ State University Police Department
AZ State University West Police Department
AZ Western College Police Department
Avondale Police Department
Benson Police Department
Bisbee Police Department
Buckeye Police Department
Bullhead City Police Department
Camp Verde Marshal's Office
Casa Grande Police Department
Central AZ College Police Department
Chandler Police Department
Chino Valley Police Department
Clarkdale Police Department
Cochise County Sheriff's Office
Coconino County Sheriff's Office
Coolidge Police Department
Cottonwood Police Department
Douglas Police Department
Eagar Police Department
El Mirage Police Department
Eloy Police Department
Flagstaff Police Department
Florence Police Department
Gila County Sheriff's Office
Gilbert Police Department
Glendale Police Department
Globe Police Department
Goodyear Police Department
Graham County Sheriff's Office
Greenlee County Sheriff's Office
Hayden Police Department
Hobbrook Police Department
Huachuca City Police Department
Jerome Police Department
Kearny Police Department
Kingman Police Department
Lake Havasu City Police Department
La Paz County Sheriff's Office
Mammoth Police Department
Marana Police Department
Maricopa County Sheriff's Office
Mesa Police Department
Miami Police Department
Mohave County Sheriff's Office

Navajo County Sheriff's Office
Nogales Police Department
Northern AZ University Police Department
Oro Valley Police Department
Page Police Department
Paradise Valley Police Department
Parker Police Department
Payson Police Department
Peoria Police Department
Phoenix Police Department
Pima College Police Department
Pima County Sheriff's Office
Pima Police Department
Pinal County Sheriff's Office
Pinetop-Lakeside Police Department
Prescott Police Department
Prescott Valley Police Department
Quartzsite Marshal's Office
Safford Police Department
St. Johns Police Department
San Luis Police Department
Santa Cruz County Sheriff's Office
Scottsdale Police Department
Sedona Police Department
Show Low Police Department
Sierra Vista Police Department
Snowflake-Taylor Police Department
Somerton Police Department
South Tucson Police Department
Springerville Police Department
State Capitol Police Department
Superior Police Department
Surprise Police Department
Tempe Police Department
Thatcher Police Department
Tolleson Police Department
Tombstone Marshal's Office
Tucson Police Department
University of AZ Police Department
Wellton Marshal's Office
Wickenburg Police Department
Willcox Police Department
Winslow Police Department
Yavapai College Police Department
Yavapai County Sheriff's Office
Youngtown Police Department
Yuma County Sheriff's Office
Yuma Police Department

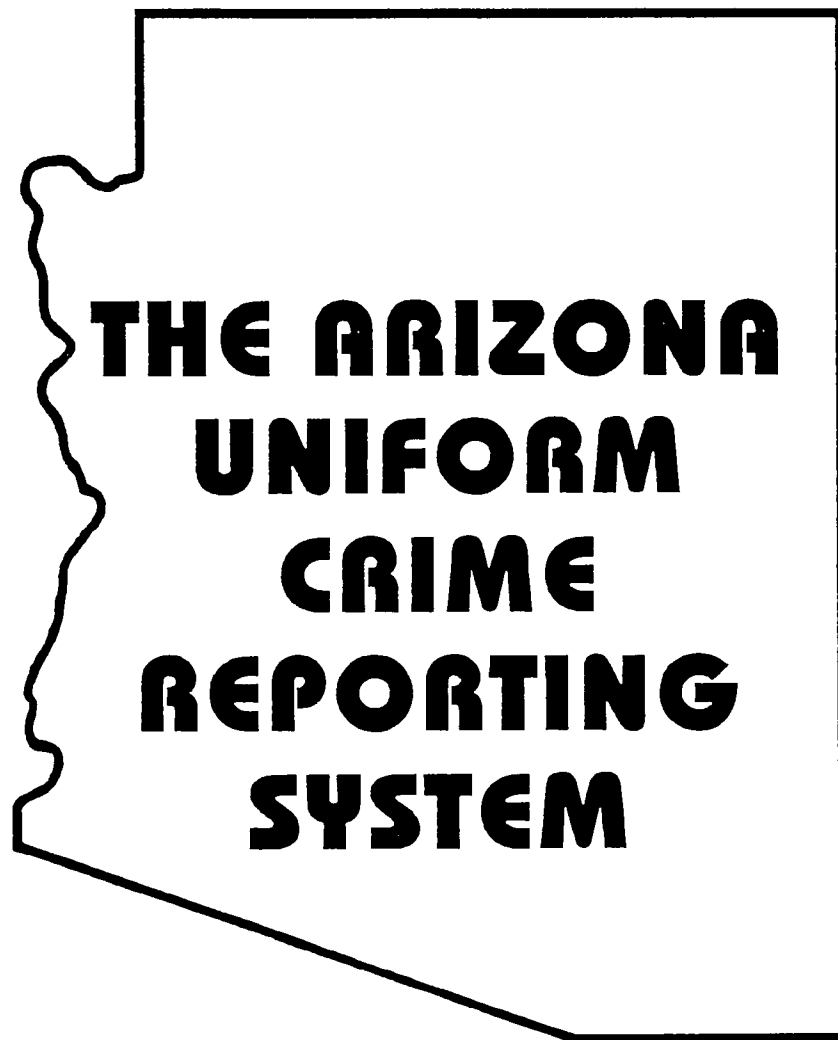

**THE ARIZONA
UNIFORM
CRIME
REPORTING
SYSTEM**

HISTORY OF UNIFORM CRIME REPORTING

The Committee on Uniform Crime Records of the International Association of Chiefs of Police (IACP) was established in 1927 to initiate a national program for collecting crime information. This Committee's responsibility to provide management information to law enforcement agencies was eventually turned over to the Federal Bureau of Investigation (FBI) in 1930, when the FBI received a Congressional mandate to collect and disseminate national crime information. The IACP has continued to serve the Uniform Crime Reporting (UCR) Program in an advisory capacity and was joined in this responsibility by the Committee on Crime Records of the National Sheriff's Association (NSA) in 1966.

The Arizona Uniform Crime Reporting (AUCR) Section first began receiving voluntary crime information from Arizona law enforcement agencies in January 1975. Prior to this date these agencies submitted their crime data directly to the FBI.

OBJECTIVES OF ARIZONA UCR

Due to increased attention being focused on the problem of crime in our communities in recent years, many segments of our population need more complete information for a variety of reasons.

Law enforcement professionals, managers and administrators who must focus on crime in their own jurisdictions, also need to know what is occurring in surrounding jurisdictions in order to deploy personnel and equipment more efficiently. Researchers and planners need to know what is actually happening to predict trends and recommend changes.

The goal of the *Crime in Arizona* is to identify the nature and extent of criminal activity in this state and present the information needed by each of these groups. This information will not in itself prevent crime, but it may encourage all segments of society, by understanding the problem, to work together with law enforcement agencies to reduce crime through more effective enforcement.

The objectives of the *Crime in Arizona* are: (1) To identify the nature and extent of crime in our state; (2) To provide the management information needed by the law enforcement community to augment their ability to attack the crime problem; (3) To provide our citizens with the most complete information available; (4) To provide legislators with the information necessary to formulate laws which address the crime problem; and (5) To provide sufficient detailed data for researchers and planners.

CONSIDERATIONS FOR INTERPRETATION

Statistics are tools used to summarize information so that patterns or trends become clearer. All statistics must be interpreted with an understanding of just what it is that they can say. Too often information of the type in this report is used incorrectly to draw conclusions that the statistics simply do not support. We ask that great care be taken in analysis and interpretation.

The following factors have a major influence on the statistics presented in this report:

1. Crime figures are police statistics as distinguished from the findings of a court, coroner, jury or decision of a prosecutor.
2. Density and size of community population.
3. Variations in composition of the population particularly age structure.
4. Stability of population with respect to transient factors.
5. Economic conditions, including job availability.
6. Climate.
7. Effective strength of law enforcement agencies; some police jurisdictions overlap.
8. Attitudes of citizenry toward crime.
9. Crime reporting practices of citizenry.
10. Crime rates are based on census-fixed residential populations of police jurisdictions.
11. Crimes committed on Indian reservations are not reported to the AUCR program, although their population is included in the state's population figures.
12. Incomplete or zero data from reporting agencies or non-participation of some local law enforcement agencies. The number of these agencies will vary from year to year.

To obtain accurate information from many different agencies, the national UCR program had to precisely define the methods for collecting such information as the number of offenses, arrests, clearances and value of stolen or recovered property.

Classification of Offenses

UCR divides offenses into two major classifications which are designated Part I and Part II offenses. This distinction is important to keep in mind because different information is collected for each.

Part I offenses include:

Violent Crimes

- Criminal Homicide
- Forcible Rape
- Robbery
- Aggravated Assault

Property Crimes

- Burglary
- Larceny-Theft
- Motor Vehicle Theft
- Arson

Part II offenses include:

- Other Assaults-simple
- Forgery and Counterfeiting
- Fraud
- Embezzlement
- Stolen Property; Buying, Receiving, Possessing, etc.
- Vandalism
- Weapons; Carrying, Possessing, etc.
- Prostitution
- Sex Offenses (except forcible rape and prostitution)
- Narcotic Drug Laws
- Gambling
- Offenses Against Family and Children
- Driving Under the Influence
- Liquor Laws
- Drunkenness (not reported in Arizona)
- Disorderly Conduct
- Vagrancy
- All Other Offenses (except traffic)
- Suspicion (not reported in Arizona)
- Curfew and Loitering Law Violations (Juveniles)
- Runaways (Juveniles)

Note: Only arrests are counted for Part II offenses.

All offenses are classified on the basis of law enforcement officer investigation in accordance with UCR offense definitions (which will not necessarily be identical to Criminal Code definitions). Because UCR identifies a police problem, offense classifications are not based on the findings of a court, coroner, jury or decisions of a prosecutor.

Counting of Offenses

The number of offenses is collected only for Part I crimes and simple assault. The method of counting offenses varies with the type of crime committed, and it is important to remember that the number of offenders does not determine the number of offenses.

For murder and nonnegligent manslaughter, negligent manslaughter, rape, aggravated assault and simple assault, one offense is counted for each victim, regardless of the number of offenders involved.

For robbery and larceny-theft, one offense is counted for each distinct operation which is separate in time and place. The number of victims in any one operation does not determine the number of offenses.

For burglary, one offense is counted for each structure which is illegally entered. However, when the structure is an apartment house, business or office building in which units are leased for a period of time, one offense is counted for each unit burglarized.

For motor vehicle theft, one offense is counted for each vehicle stolen.

Note: Attempts to commit any one of the above are also counted as offenses, except that attempts to kill and assaults to kill are counted as aggravated assaults.

For multiple offenses that occur in one crime incident, only the most serious offense is counted. In cases when an arson occurs in conjunction with other Part I crimes, both are reported. Part I offenses are ranked according to seriousness and appear in order from most serious to least serious under "Classifications of Offenses."

Clearances

An offense is considered cleared (solved) when at least one offender is arrested for a crime, even though several may have been involved.

Offenses may also be cleared by exceptional means when the offender: commits suicide; makes a dying declaration; confesses while in custody or serving time for another crime; is prosecuted in another jurisdiction for the same offense; is a juvenile who is handled by notifying the parents; when the victim refuses to prosecute or another jurisdiction refuses to extradite the offender.

Clearances are counted as "adult" and "juvenile". A "juvenile" clearance is counted only when juveniles are *exclusively* involved in the clearance of an offense. If the arrest of both adults and juveniles

results in a clearance, it is counted as an "adult" clearance.

Property Stolen and Recovered

The figures for value of property stolen and recovered report the value at each point in time. Although property can increase in value over time, it is more likely that stolen property will be recovered in a damaged condition. Therefore, recovery value does not necessarily represent a "clearance rate" for stolen property, and one cannot use it to determine law enforcement effectiveness in recovering stolen goods. Because stolen and recovered property figures indicate thefts and recoveries in the current year, it is important to note that recovered property may have been stolen in a previous year. In addition, the type and value of stolen or recovered property is reported only for Part I offenses and does not include such Part II offenses as fraud, forgery or embezzlement.

Arrests

Arrest information is collected for all Part I and Part II offenses according to the age, sex and race of the offender. It is not possible, however, to correlate race with sex or specific ages because the information is collected independently, thus limiting analysis. Furthermore, arrest figures cannot be directly related to the number of crimes cleared because arrest totals count all offenders arrested for each offense, and clearance totals count only the offenses for which an arrest(s) or exceptional clearance(s) has occurred.

Reporting Variations and Procedures

One must be aware that unintentional variations from UCR guidelines may occur that would affect the validity of the data presented in this report. Offense totals vary from the actual number of offenses that occur because UCR statistics are based on crimes that are reported to law enforcement agencies and many crimes are not reported.



**SUMMARY
OF STATE
CRIME DATA**

ARIZONA CRIME CLOCK 1995

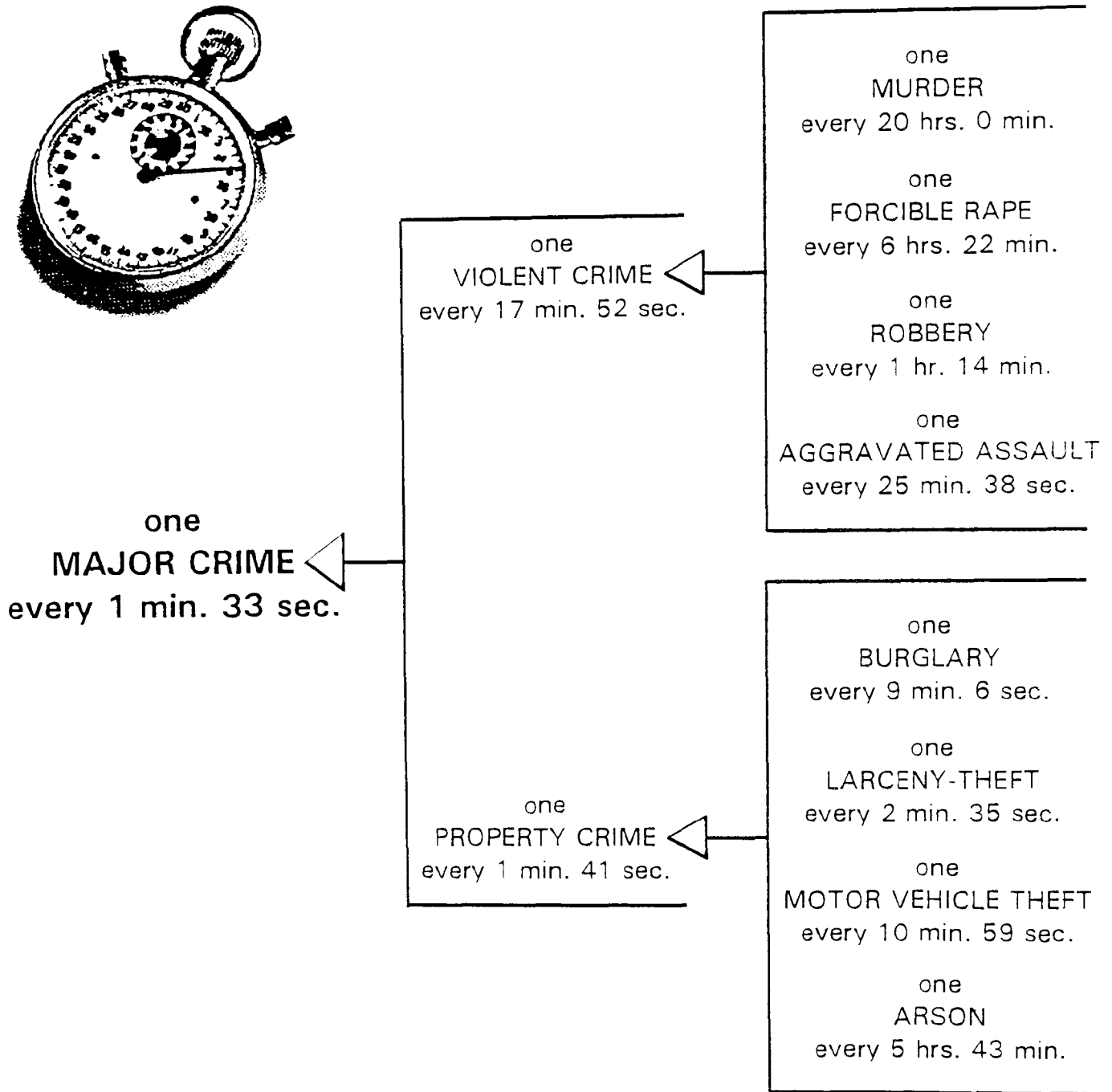
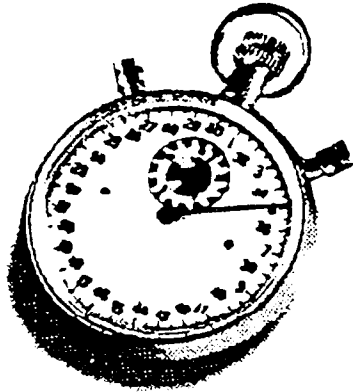

The crime clock should be viewed with care. Being the most aggregate representation of UCR data, it is designed to convey the annual reported crime experience by showing the relative frequency of occurrence of the Offenses. This mode of display should not be taken to imply a regularity in the commission of the Offenses; rather, it represents the annual ratio of crime to affixed time intervals.

ARIZONA CRIME CYCLE

The following represents the approximate number of Crime Index Offenses that were reported to Arizona law enforcement agencies every 24 hours during 1995.

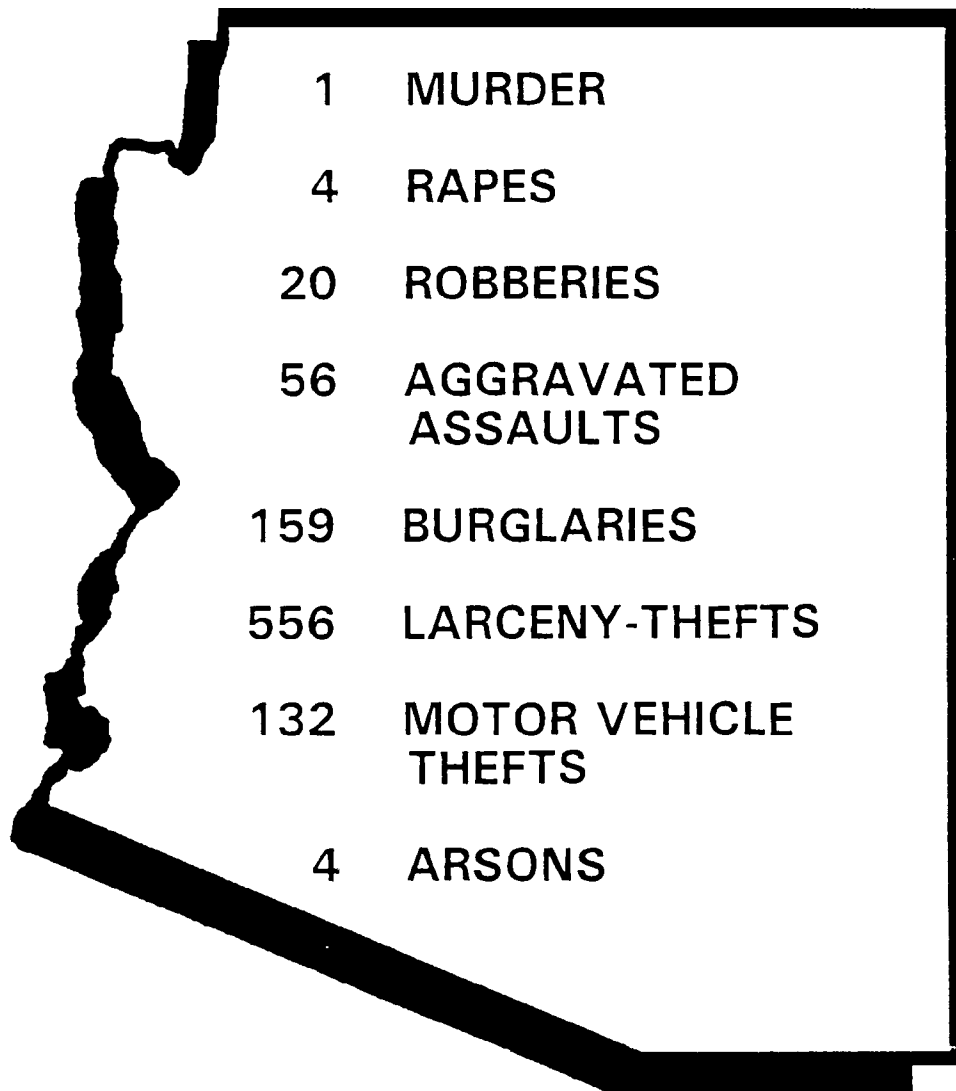

STATE CRIME SUMMARY

CRIME INDEX OFFENSES

- There were 339,978 Crime Index Offenses reported in 1995.
- October recorded the highest incidence of offenses with 30,882 reported while February recorded the lowest incidence of offenses with 26,221 reported.
- The value of property stolen amounted to \$395,024,568 in 1995.
- The value of property recovered amounted to \$161,573,680 for a recovery rate of 40.9 percent.
- The crime rate for 1995 for Arizona was 8,039.2 crimes per 100,000 population.

CRIME INDEX ARRESTS/CLEARANCES

- During 1995, a total of 61,649 persons were arrested for Index offenses.
- Adult Index arrests were 42,452 and juvenile arrests were 19,197.
- Males accounted for 76.0 percent of the Index arrests and females accounted for 24.0 percent.
- There were 60,808 clearances, or 17.9 percent, of Index Offenses reported in 1995. Juveniles represented 22.2 percent of this total.

VIOLENT CRIME

OFFENSES

- A total of 29,354 violent crimes were reported in 1995.
- Violent crimes accounted for 8.6 percent of the total Crime Index.
- The highest number of violent crimes was reported in September with 2,995 offenses while the lowest number was reported in December with 2,168 offenses.
- Aggravated assault accounted for the largest incidence of violent crimes with 20,396 offenses while homicide accounted for the smallest with 440 offenses.
- The value of property stolen was \$6,873,564.
- The crime rate was 694.1 offenses per 100,000 population.

ARRESTS/CLEARANCES

- There were 9,955 arrests for violent crimes in 1995.
- Adult arrests were 7,593 and juvenile arrests were 2,362.
- Males accounted for 86.4 percent and females accounted for 13.6 percent.
- There were 11,372 clearances, or 38.7 percent, of violent crimes reported in 1995. Juveniles represented 17.2 percent of this total.

PROPERTY CRIME

OFFENSES

- A total of 310,624 property crimes were reported in 1995.
- Property crimes accounted for 91.4 percent of the total Crime Index.
- The highest number of property crimes were reported in October with 28,118 offenses while the lowest number was reported in February with 24,008 offenses.
- Larceny-theft accounted for the largest incidence of property crimes with 202,874 offenses while arson accounted for the smallest with 1,532 offenses.
- The value of property stolen was \$388,151,004.
- The crime rate was 7,345.1 offenses per 100,000 population.

ARRESTS/CLEARANCES

- There were 51,694 arrests for property crimes in 1995.
- Adult arrests were 34,859 and juvenile arrests were 16,835.
- Males accounted for 73.9 percent and females accounted for 26.1 percent.
- There were 49,436 clearances, or 15.9 percent, of property crimes reported in 1995. Juveniles represented 23.4 percent of this total.

TOTAL ARRESTS

- There were 301,497 persons arrested in 1995.
- Adult arrests were 232,755 and juvenile arrests were 68,742.
- Males accounted for 78.5 percent and females accounted for 21.5 percent.
- Part I offenses accounted for 61,649 arrests.
- Part II offenses accounted for 239,848 arrests.

The following agencies provided zero (0) data for 1995: Clarkdale P.D. (Yavapai Co.), Clifton P.D. (Greenlee Co.), Eloy P.D. (Pinal Co.), Fredonia M.O (Coconino Co.), Oro Valley P.D. (Pima Co.), Page P.D. (Coconino Co.), Parker P.D. (La Paz Co.), Patagonia M.O (Santa Cruz Co.), Williams P.D. (Coconino Co.), and Yuma P.D. (Yuma Co.)

The following agencies provided only partial data for 1995: Douglas P.D. (Cochise Co.), Gila County S.O , Wellton M.O (Yuma Co.), and Yuma County S.O

TOTAL INDEX CRIMES BY MONTH

INDEX CRIMES	TOTAL	JAN	FEB	MAR	APR	MAY	JUN	JUL	AUG	SEP	OCT	NOV	DEC
Murder	440	45	22	44	20	39	31	39	51	39	46	28	36
Forcible Rape	1,379	99	98	122	127	118	125	110	115	145	127	109	24
Robbery	7,139	500	549	584	559	492	504	554	638	680	706	715	658
Aggravated Assault	20,396	1,585	1,544	1,689	1,649	1,770	1,588	1,672	1,899	2,131	1,885	1,594	1,390
Burglary	58,199	5,321	4,510	5,074	4,698	4,775	4,494	4,638	5,118	5,124	5,179	4,717	4,551
Larceny-Theft	202,874	17,066	15,394	17,420	15,832	16,788	16,383	16,603	16,971	17,346	18,180	17,565	16,326
Motor Vehicle Theft	48,019	4,061	3,504	3,795	3,455	3,592	3,846	4,172	4,623	4,493	4,620	4,149	3,709
Arson	1,532	147	100	110	118	152	137	156	114	106	139	131	122
TOTAL	339,978	28,824	26,221	28,838	26,458	27,726	27,108	27,944	29,529	30,064	30,882	29,008	27,376

INDEX CRIMES CLEARED*

(Percent of Total)

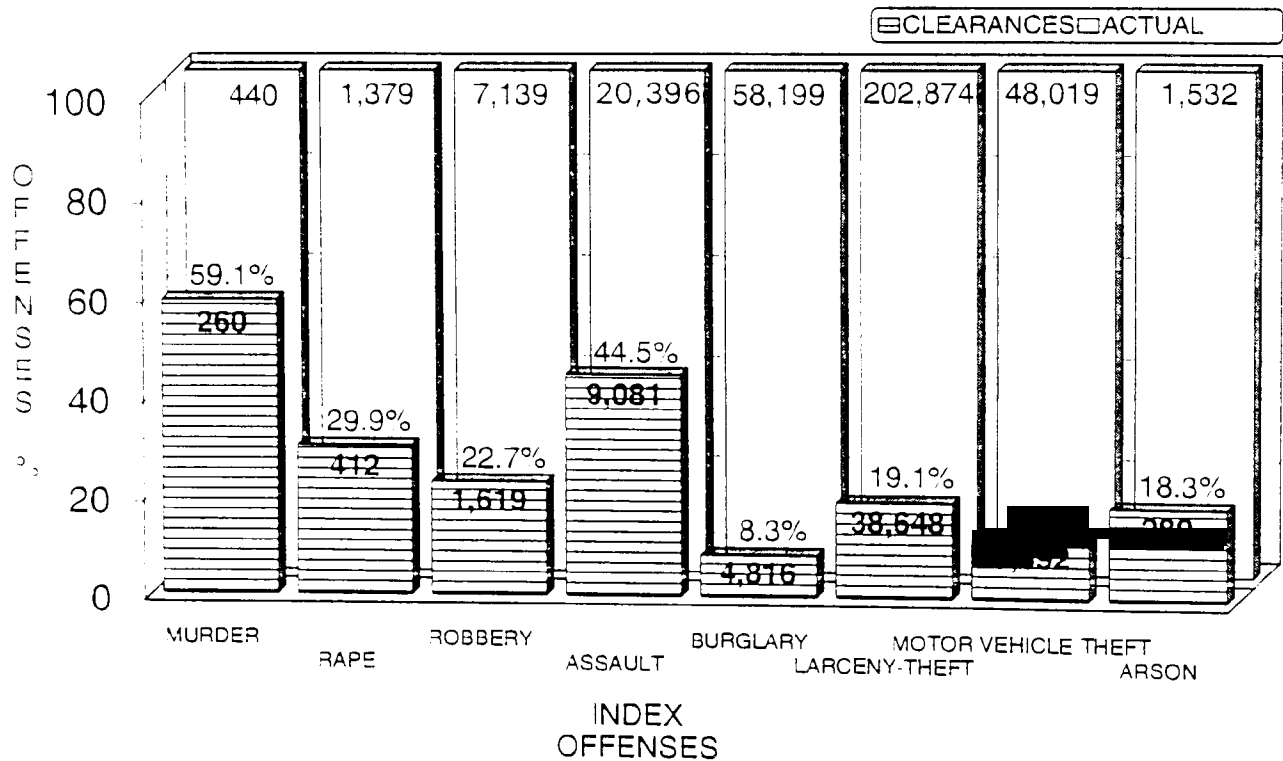

* Clearances may include offenses which were reported in prior years.

INDEX CRIME COMPARISON*

INDEX OFFENSES		Number of Offenses	Number of Offenses Cleared	Percent of Offenses Cleared
Murder	1994	417	270	64.75
	1995	439	259	59.00
	Percent Change	+5.28	-4.07	-8.88
Forcible Rape	1994	1,404	432	30.77
	1995	1,378	411	29.83
	Percent Change	-1.85	-4.86	-3.06
Robbery	1994	6,473	1,574	24.32
	1995	7,132	1,615	22.64
	Percent Change	+10.18	+2.60	-6.91
Aggravated Assault	1994	19,532	9,319	47.71
	1995	20,224	8,958	44.29
	Percent Change	+3.54	-3.87	-7.17
Burglary	1994	58,422	5,404	9.25
	1995	57,883	4,784	8.26
	Percent Change	-.92	-11.47	-10.70
Larceny-Theft	1994	184,295	35,326	19.17
	1995	201,624	38,404	19.05
	Percent Change	+9.40	+8.71	-0.63
Motor Vehicle Theft	1994	41,873	4,818	11.51
	1995	47,864	5,653	11.81
	Percent Change	+14.31	+17.33	+2.61
Arson	1994	1,309	252	19.25
	1995	1,524	279	18.31
	Percent Change	+16.42	+10.71	-4.88
TOTAL INDEX CRIMES	1994	313,725	57,395	18.29
	1995	338,068	60,363	17.86
	Percent Change	+7.76	+5.17	-2.35

*For the purposes of this comparison chart only, statistics from eight agencies have been excluded. These agencies were unable to provide complete data for a full twelve month period in 1994 and/or 1995. These agencies are: Clarkdale P.D., Douglas P.D., Jerome P.D., NAU P.D., Parker P.D., Pima P.D., Wellton M.O., and Yuma County S.O.

(Figures for 1994 may have been updated and therefore may vary from previously published statistics.)

VALUE OF PROPERTY LOSS BY INDEX CRIME OFFENSE- STATE TOTALS

OFFENSE	Number of Offenses	Dist.	(\$) Value of Property Stolen	Dist.	Average (\$) Value
Murder	440	0.1%	61,145	0.02%	138.97
Forcible Rape	1,379	0.4%	11,940	0.01%	8.66
Robbery	7,139	2.3%	6,800,479	1.72%	952.58
Burglary	58,199	18.3%	83,347,272	21.09%	1,432.11
Larceny-Theft	202,874	63.8%	84,379,616	21.36%	415.92
Motor Vehicle Theft*	48,019	15.1%	220,424,116	55.80%	4,590.35
TOTAL	318,050	100.0%	\$395,024,568	100.00%	\$1,242.02

**Motor vehicles that were stolen in conjunction with a more "serious" index offense such as robbery or burglary are not included in this count. This count represents only those instances in which motor vehicle theft was the only or most "serious" offense committed. The total value shown here reflects the value of all property stolen during the commission of the offense (i.e., not just the value of each vehicle).*

TYPE AND VALUE OF PROPERTY STOLEN AND RECOVERED- STATE TOTALS

TYPE OF PROPERTY	(\$) Value Stolen	Dist.	(\$) Value Recovered	Percent Recovered
Currency and Notes	10,627,655	2.7%	642,973	6.0%
Jewelry and Precious Metals	27,864,564	7.1%	1,043,044	3.7%
Clothing and Furs	5,190,519	1.3%	690,839	13.3%
Locally Stolen Motor Vehicles	219,123,671	55.5%	147,566,263	67.3%
Office Equipment	13,889,397	3.5%	635,745	4.6%
TVs, Radios, Cameras, Etc.	30,766,334	7.8%	1,184,045	3.8%
Firearms	4,475,754	1.1%	560,006	12.5%
Household Goods	7,399,237	1.9%	375,543	5.1%
Consumable Goods	1,654,672	0.4%	302,926	18.3%
Livestock	2,833,926	0.7%	19,647	0.7%
Miscellaneous	71,198,839	18.0%	8,552,649	12.0%
TOTAL	\$395,024,568	100.0%	\$161,573,680	40.9%



**PART 1
INDEX
CRIMES**

VIOLENT CRIMES

- Murder
- Rape
- Robbery
- Aggravated Assault

PROPERTY CRIMES

- Burglary
- Larceny-Theft
- Motor Vehicle Theft
- Arson

MURDER AND NONNEGLIGENT MANSLAUGHTER

DEFINITION

The willful (nonnegligent) killing of one person by another. As a general rule, any death due to injuries received in a fight, argument, quarrel, assault, or commission of a crime would be included. Attempted murders and assaults to murder are classified as aggravated assaults. Suicides, traffic fatalities, accidental deaths, negligent manslaughters, and justifiable homicides are not counted under this classification.

SUMMARY

- There were 440 murders reported during 1995.
- Murder accounted for 0.1 percent of the total Index offenses and 1.5 percent of the total violent crimes.
- August recorded the highest number, with 51, while April recorded the lowest with 20.
- Saturday reported the highest incidence of murders, with 87, while Wednesday was the lowest with 40.
- The time period of 6:01 PM - 2:00 AM recorded the highest number of murders, with 210, while 10:01 AM - 6:00 PM was the lowest with 103.
- Firearms (including handguns, rifles, shotguns, etc.) were used in 75.7 percent of the murders.
- In murders where the relationship between the victim and offender was known, 18.9 percent were acquaintances.

ARRESTS/CLEARANCES

- A total of 307 persons were arrested in 1995.
- Adults accounted for 264 arrests and juveniles accounted for 43 arrests.
- Males accounted for 91.2 percent and females accounted for 8.8 percent.
- There were a total of 260 clearances for murder reported in 1995. Juveniles represented 11.2 percent of this total.

MURDER BY MONTH

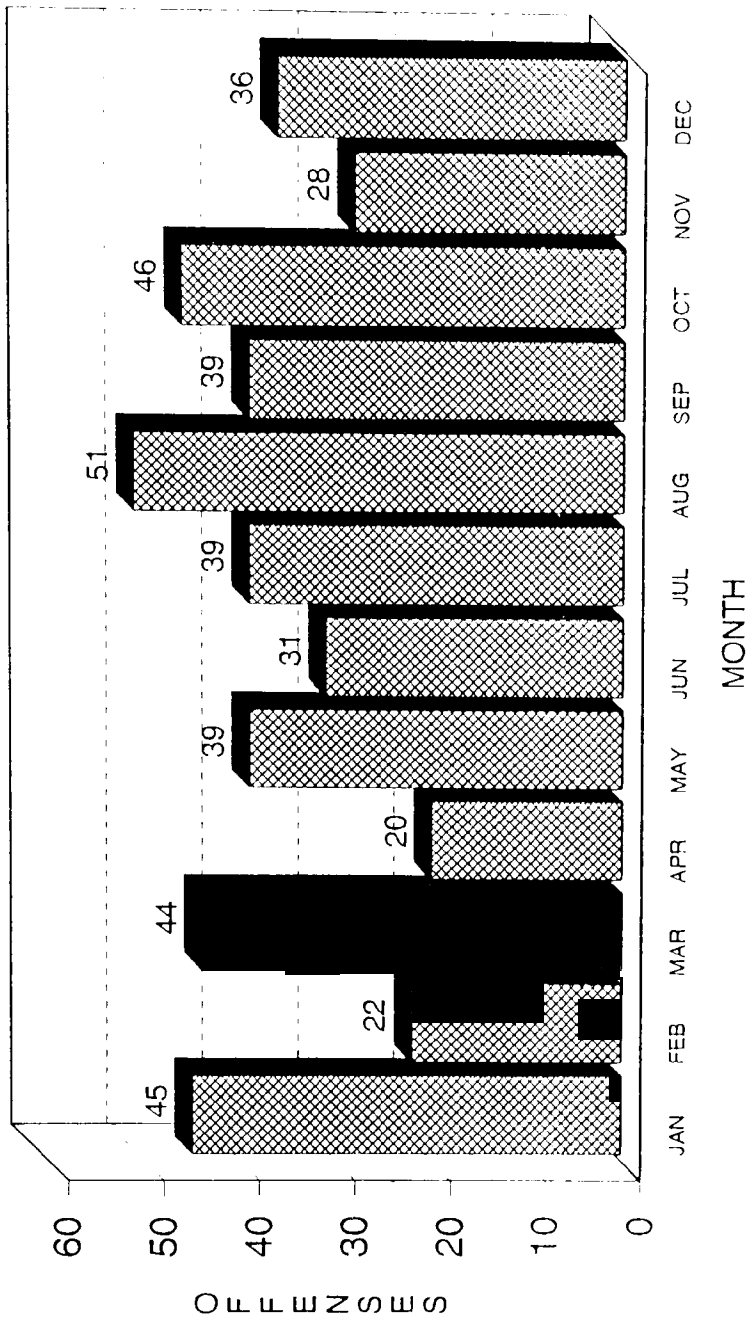

MURDER BY DAY OF WEEK

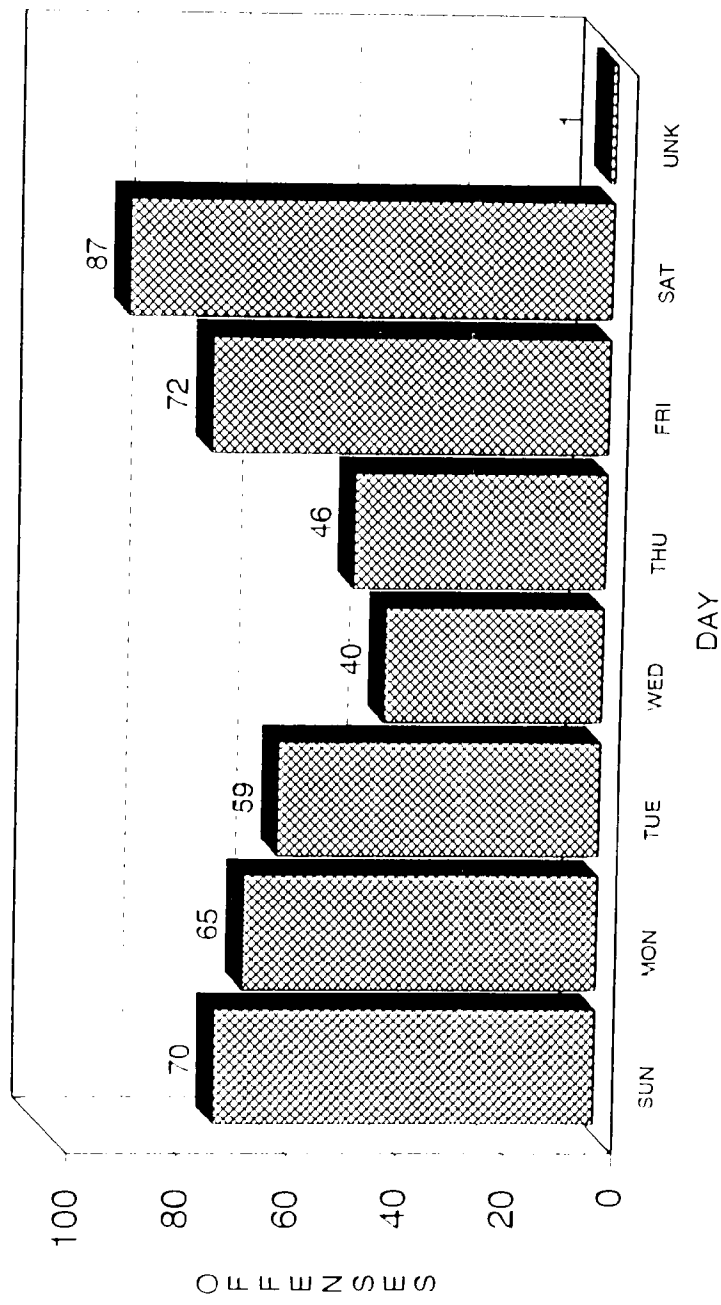

MURDER BY TIME OF DAY

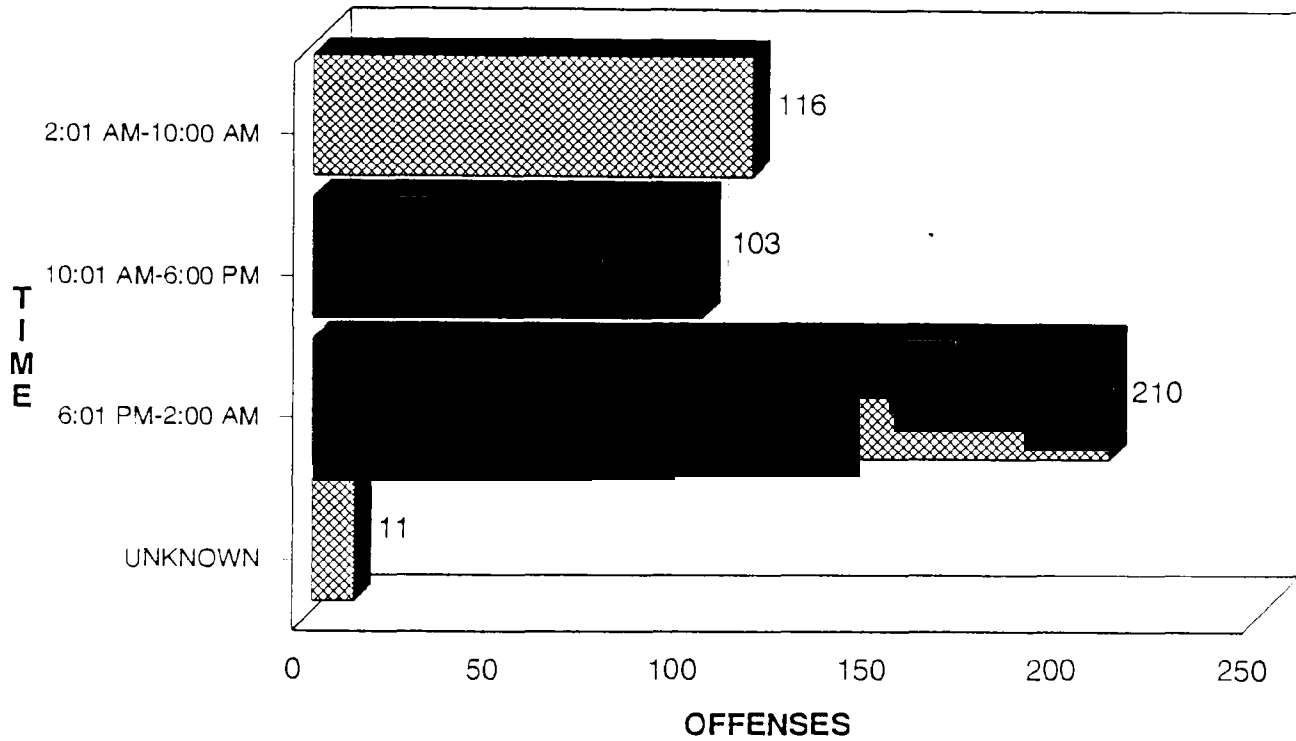

MURDER DISTRIBUTION BY CIRCUMSTANCE

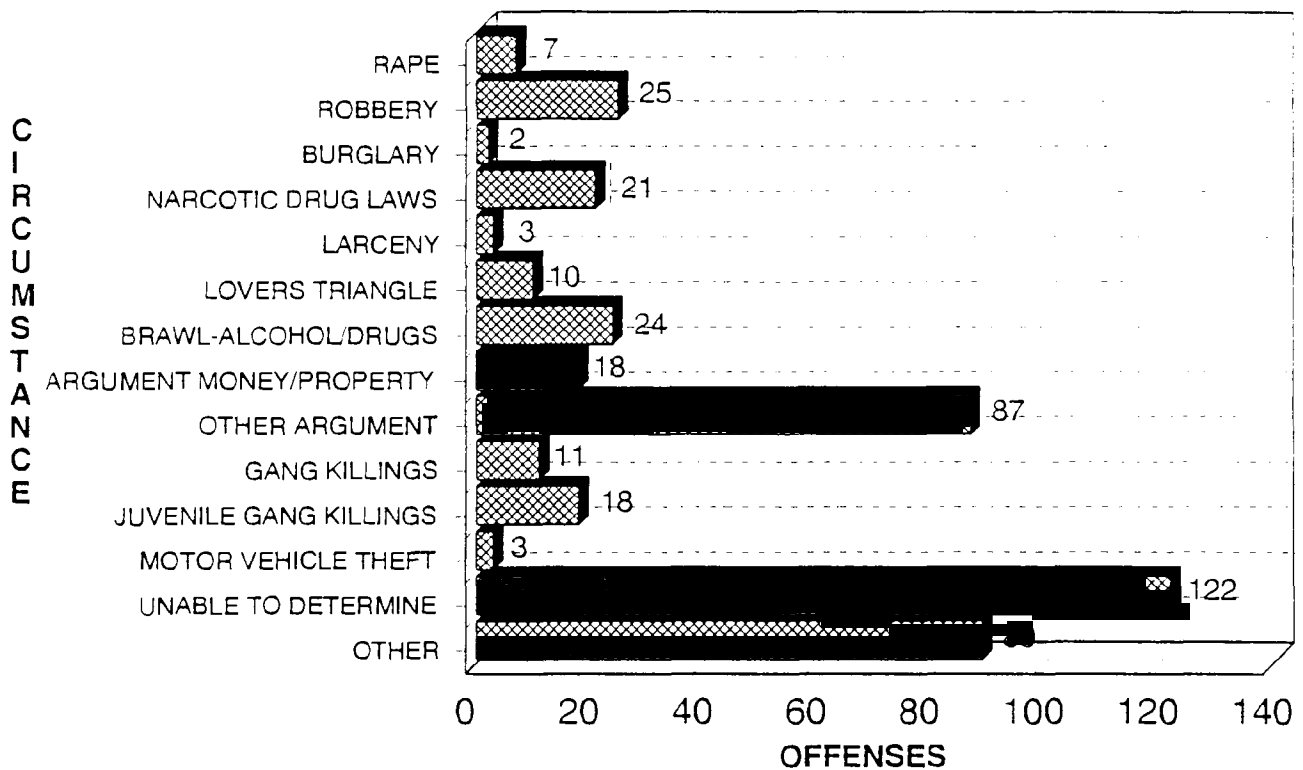

MURDER BY TYPE OF WEAPON USED

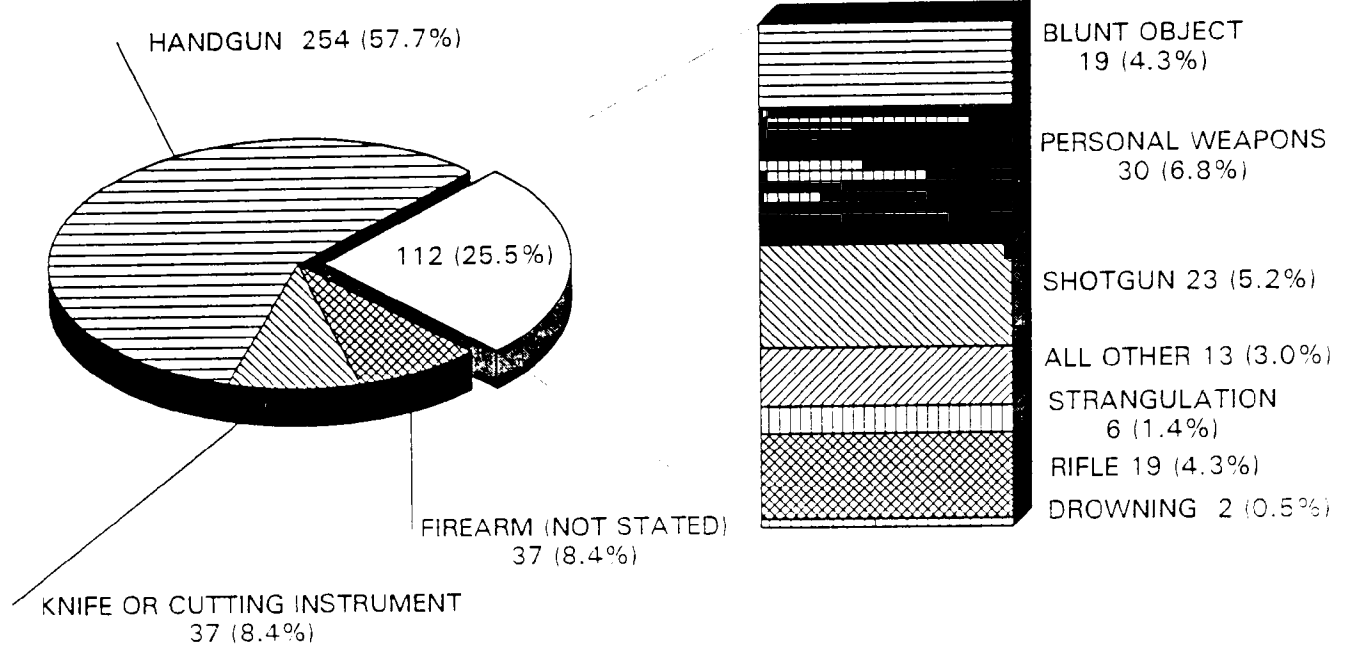

MURDER DISTRIBUTION BY RELATIONSHIP

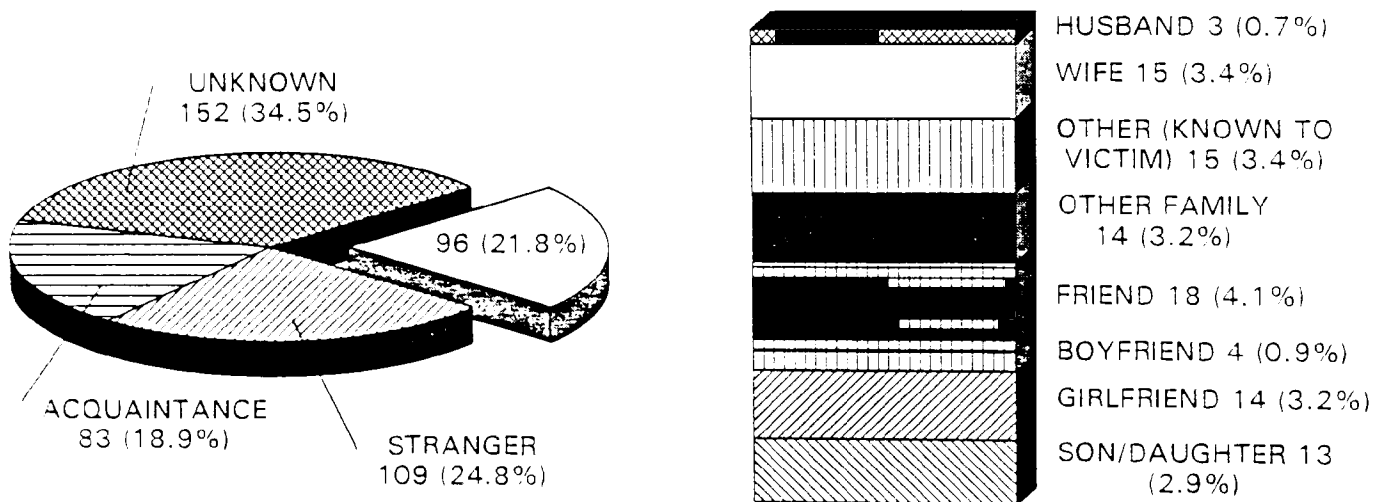

MURDER VICTIM BY AGE, SEX, RACE & ETHNIC ORGIN

AGE	NUMBER	DISTRIBUTION	SEX		RACE				ETHNIC ORGIN	
			MALE	FEMALE	WHITE	BLACK	INDIAN	ASIAN	HISPANIC	NOT HISPANIC
Infant	7	1.6%	5	2	6	--	1	--	2	5
1-4	9	2.0%	7	2	6	2	1	--	2	7
5-9	2	0.5%	1	1	1	--	1	--	--	2
10-14	9	2.0%	5	4	6	2	1	--	5	4
15-19	74	16.8%	63	11	52	20	2	--	34	40
20-24	63	14.3%	57	6	58	4	1	--	38	25
25-29	63	14.3%	54	9	53	9	--	1	33	30
30-34	43	9.8%	35	8	38	3	1	1	18	25
35-39	43	9.8%	32	11	35	4	4	--	9	34
40-44	45	10.2%	30	15	44	1	--	--	16	29
45-49	22	5.0%	17	5	19	3	--	--	3	19
50-54	12	2.7%	9	3	10	1	1	--	1	11
55-59	10	2.3%	9	1	8	1	1	--	--	10
60-64	3	0.7%	2	1	2	1	--	--	--	3
65-69	7	1.6%	6	1	7	--	--	--	1	6
70-74	7	1.6%	4	3	6	1	--	--	--	7
75 +	6	1.4%	--	6	6	--	--	--	--	6
Unknown	15	3.4%	14	1	9	3	2	--	7	6
TOTAL	440	--	350	90	366	55	16	2	169	269
Distribution	--	100.0%	79.5%	20.5%	83.2%	12.5%	3.6%	0.5%	38.4%	61.1%
Adult	362	82.3%	289	73	310	42	8	2	135	227
Juvenile	63	14.3%	47	16	47	10	6	--	27	36
Unknown	15	3.4%	14	1	9	3	2	--	7	6

RAPE

DEFINITION

The carnal knowledge of a female through the use of force or threat of force. Assaults or attempts to commit forcible rape are also included; however, statutory rape (without force) and other sex offenses are not counted in this category. By definition, sex attacks on males are excluded and are classified as assaults or "other sex offenses" depending on the nature of the crime and the extent of injury.

SUMMARY



- There were 1,379 rapes reported during 1995.
- Rape accounted for 0.4 percent of the total index offenses and 4.7 percent of violent crimes.
- September recorded the highest number, with 145, while December recorded the lowest with 84.
- Of the total rapes, forcible accounted for 1,122 offenses and attempted accounted for 257 offenses.

ARRESTS/CLEARANCES

- A total of 266 persons were arrested in 1995.
- Adults accounted for 225 arrests and juveniles accounted for 41 arrests.
- There were 412 clearances for rape reported in 1995. Juveniles represented 10.4 percent of this total.

RAPE BY MONTH

(Total Offenses)

 ATTEMPTED FORCIBLE RAPE
 ACTUAL RAPE

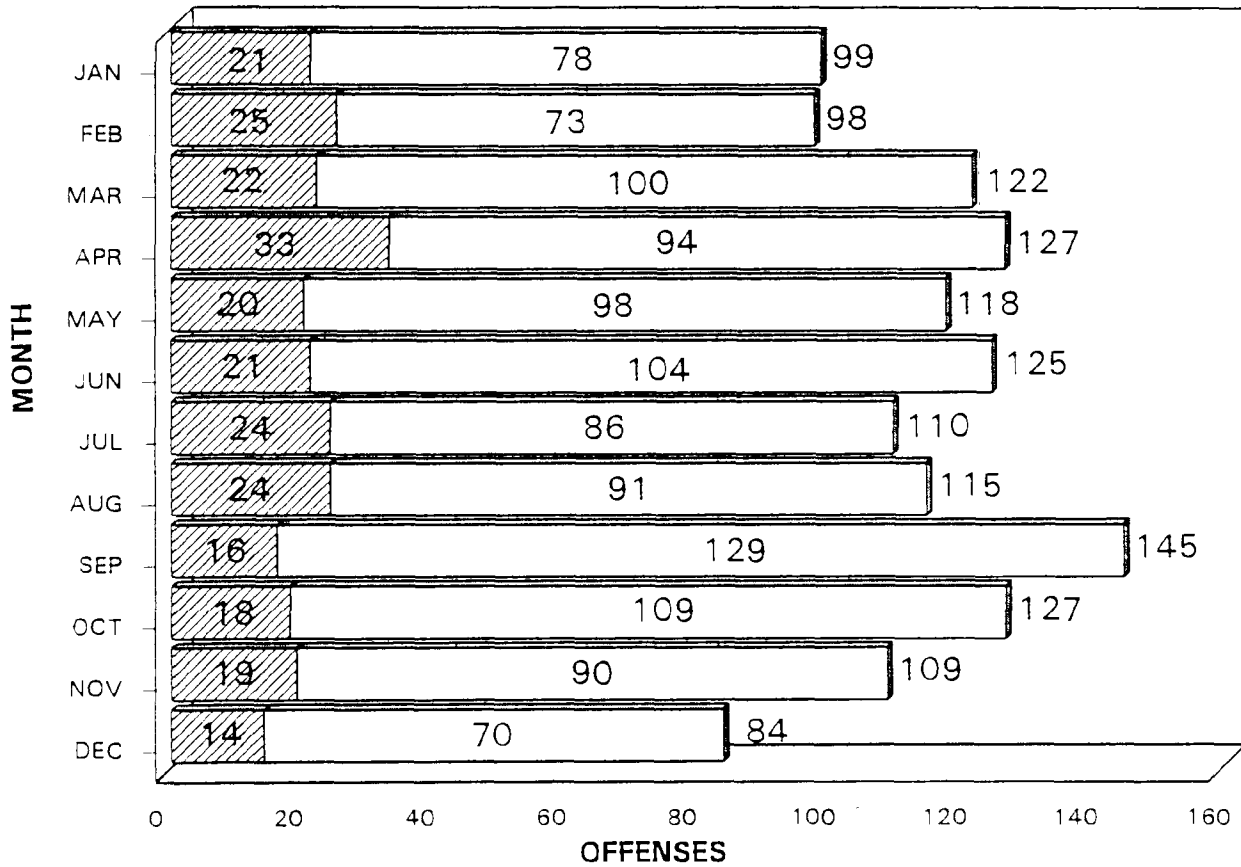

ROBBERY

DEFINITION

The taking or attempting to take anything of value from the care, custody, or control of a person by force or threat of force and/or by putting the victim in fear. Robbery involves a theft or larceny but is aggravated by the element of force or threat of force.

SUMMARY

- There were 7,139 robberies reported during 1995.
- Robbery accounted for 2.1 percent of the total Index offenses and 24.3 percent of the violent crimes.
- November recorded the highest number, with 715, while May recorded the lowest with 492.
- Robberies occurring on highways (streets, alleys, and sidewalks) recorded the highest number, with 3,896 or 54.6 percent of all robberies.
- Gas or service station robberies had the lowest number, with 109, or 1.5 percent of all robberies.
- Robberies occurring on highways (streets, alleys, and sidewalks) had the highest total dollar loss, with \$3,939,952.
- Bank robberies had the highest dollar loss per robbery, with \$2,868.
- Firearms represented the most common weapon used in 2,989 robberies, or 41.9 percent.

ARRESTS/CLEARANCES

- A total of 1,665 persons were arrested in 1995.
- Adults accounted for 1,112 arrests and juveniles accounted for 553 arrests.
- Males accounted for 1,481 arrests, or 88.9 percent, and females accounted for 184 arrests, or 11.1 percent.
- There were 1,619 clearances for robbery reported in 1995. Juveniles represented 21.7 percent of this total.

ROBBERY BY LOCATION & VALUE

LOCATION	NUMBER OF OFFENSES	DISTRIBUTION(%)	TOTAL DOLLAR VALUE STOLEN	AVERAGE DOLLAR VALUE STOLEN
Highway	3,896	54.6%	\$3,939,952	\$1,011
Commercial House	1,010	14.1%	953,395	944
Gas or Service Station	109	1.5%	13,145	121
Convenience Store	761	10.7%	123,211	162
Residence	689	9.7%	1,042,648	1,513
Bank	166	2.3%	476,080	2,868
Miscellaneous	508	7.1%	252,048	496
TOTAL	7,139	100.0%	\$6,800,479	\$953

ROBBERY BY MONTH & WEAPON USED

WEAPON	TOTAL	JAN	FEB	MAR	APR	MAY	JUN	JUL	AUG	SEP	OCT	NOV	DEC
Firearm	2,989	196	198	224	235	213	212	245	273	290	312	305	286
Knife or Cutting Instrument	702	41	63	62	49	44	72	62	65	58	57	72	57
Other Dangerous Weapons	661	44	51	43	47	47	50	47	60	71	64	64	73
Strong Arm	2,787	219	237	255	228	188	170	200	240	261	273	274	242
TOTAL	7,139	500	549	584	559	492	504	554	638	680	706	715	658

AGGRAVATED ASSAULT

DEFINITION

The unlawful attack by one person upon another for the purpose of inflicting severe or aggravated bodily injury. This type of assault usually is accompanied by the use of a weapon or means likely to produce death or serious bodily harm.

SUMMARY

- There were 20,396 aggravated assaults reported during 1995.
- Aggravated assault accounted for 6.0 percent of the total Index offenses and 69.5 percent of the violent crimes.
- September recorded the highest number, with 2,131, while December recorded the lowest with 1,390.
- Firearms represented the most common weapon used in 7,146 aggravated assaults, or 35.0 percent.
- There were 54,294 simple assaults reported in 1995. Simple assault is primarily differentiated from aggravated assault by the seriousness of the injury and the weapon used. Simple assault is not a Crime Index offense but is reported here for the purpose of showing the total assault violence.

ARRESTS/CLEARANCES

- A total of 7,717 persons were arrested in 1995.
- Adults accounted for 5,992 arrests and juveniles accounted for 1,725 arrests.
- Males accounted for 6,578 arrests, or 85.2 percent, and females accounted for 1,139 arrests, or 14.8 percent.
- There were 9,081 clearances for aggravated assault reported in 1995. Juveniles represented 16.9 percent of this total.

[REDACTED]

[REDACTED]
[REDACTED]

[REDACTED]
[REDACTED]

[REDACTED]
[REDACTED]
[REDACTED]

[REDACTED]
[REDACTED]

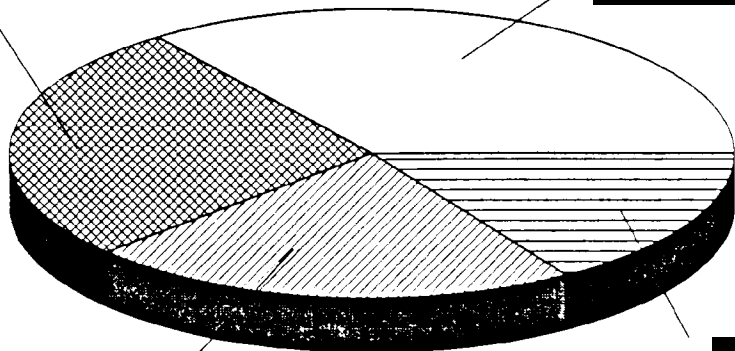

[REDACTED]

[REDACTED]
[REDACTED]
[REDACTED]
[REDACTED]
[REDACTED]
[REDACTED]

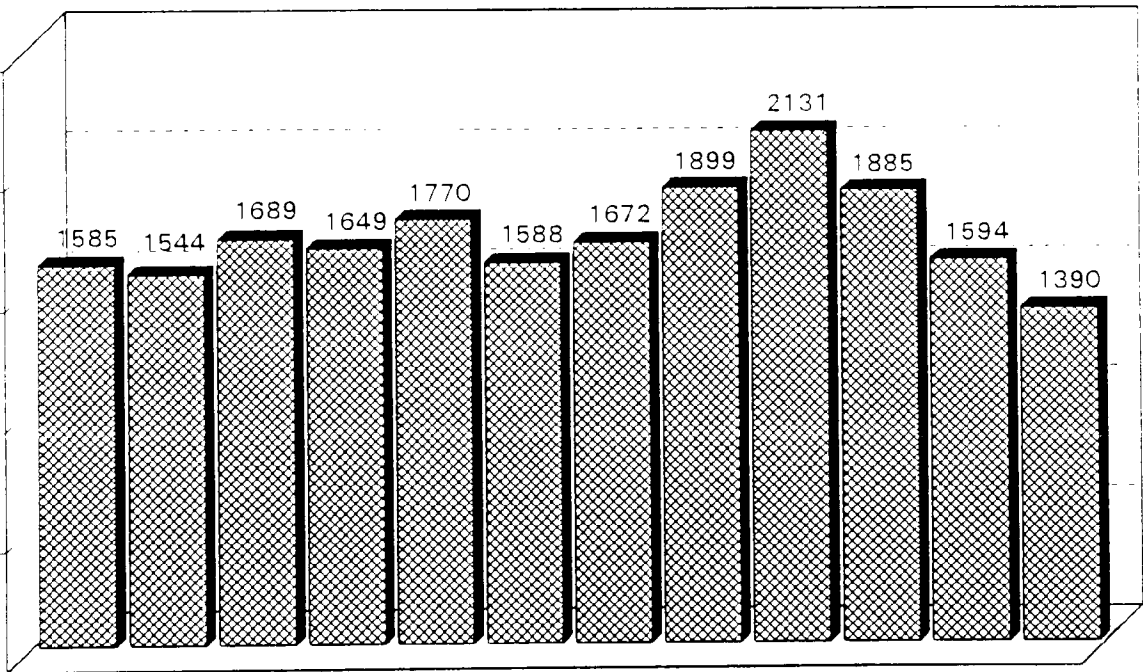

[REDACTED]

[REDACTED]

BURGLARY

DEFINITION

The unlawful entry of a structure to commit a felony or theft. The use of force to gain entry is not required to classify the crime as a burglary. A structure is considered to include, but not limited to, the following: dwelling houses, apartments, public buildings, offices, barns, cabins, etc. Burglary is divided into three subclassifications: forcible entry, unlawful entry where no force is used, and attempted forcible entry.

SUMMARY

- There were 58,199 burglaries reported during 1995.
- Burglary accounted for 17.1 percent of the total Index offenses and 18.7 percent of the property crimes.
- January recorded the highest number, with 5,321, while June recorded the lowest with 4,494.
- Forcible entry was used in 33,221, or 57.1 percent of the total burglaries.
- Residential burglaries accounted for 41,416, or 71.2 percent of the total burglaries.
- In burglaries where the time of occurrence was known, 16,577, or 28.5 percent occurred between the hours of 6 AM - 6 PM.
- Residential burglaries accounted for the highest property loss, \$58,809,226.

ARREST/CLEARANCES

- A total of 6,175 persons were arrested in 1995.
- Adults accounted for 3,604 arrests and juveniles accounted for 2,571 arrests.
- Males accounted for 5,664 arrests, or 91.7 percent, and females accounted for 511 arrests, or 8.3 percent.
- There were 4,816 clearances for burglary reported in 1995. Juveniles represented 22.9 percent of this total.

BURGLARY BY LOCATION & TIME

LOCATION	NUMBER OF OFFENSES	DISTRIBUTION	VALUE STOLEN	AVG. VALUE STOLEN
RESIDENCE				
Night (6PM-6AM)	8,278	14.2%	\$8,769,241	\$1,059
Day (6AM-6PM)	14,226	24.5%	21,234,609	1,493
Unknown	18,912	32.5%	28,805,376	1,523
SUBTOTAL	41,416	71.2%	\$58,809,226	\$1,420
NON-RESIDENCE				
Night (6PM-6AM)	5,586	9.6%	\$6,523,497	\$1,168
Day (6AM-6PM)	2,351	4.0%	2,240,363	953
Unknown	8,846	15.2%	15,774,186	1,783
SUBTOTAL	16,783	28.8%	\$24,538,046	\$1,462
TOTAL	58,199	100.0%	\$83,347,272	\$1,432

BURGLARY BY MONTH & MEANS OF ENTRY

ENTRY TYPE	TOTAL	JAN	FEB	MAR	APR	MAY	JUN	JUL	AUG	SEP	OCT	NOV	DEC
Forcible Entry	33,221	3,197	2,581	2,871	2,563	2,674	2,452	2,578	2,813	2,922	3,001	2,800	2,769
Unlawful Entry- No Force	21,048	1,766	1,631	1,865	1,798	1,751	1,728	1,746	1,962	1,848	1,317	1,611	1,525
Attempted Forcible Entry	3,930	358	298	338	337	350	314	314	343	354	361	306	257
TOTAL	58,199	5,321	4,510	5,074	4,698	4,775	4,494	4,638	5,118	5,124	5,179	4,717	4,551

LARCENY-THEFT

DEFINITION

The unlawful taking, carrying, leading, or riding away of property or articles from the possession or constructive possession of another without the use of force, violence, or fraud. This crime category does not include embezzlement, fraud, counterfeiting, or worthless checks.

SUMMARY

- There were 202,874 larceny-thefts reported during 1995.
- Larceny-theft accounted for 59.7 percent of the total Index offenses and 65.3 percent of the property crimes.
- October recorded the highest number, with 18,180, while April was the lowest with 15,832.
- Larceny-theft in the under \$50 category reported the highest number of incidents, with 95,770, or 47.2 percent.
- Shoplifting accounted for 38,509 larceny-thefts or 19.0 percent.

ARRESTS/CLEARANCES

- A total of 41,233 persons were arrested in 1995.
- Adults accounted for 29,078 arrests and juveniles accounted for 12,155 arrests.
- Males accounted for 28,886 arrests, or 70.1 percent and females accounted for 12,347 arrests, or 29.9 percent.
- There were 38,648 clearances for larceny-theft reported in 1995. Juveniles represented 23.1 percent of this total.

LARCENY-THEFT BY TYPE BY MONTH

CLASSIFICATION	TOTAL	DIST.	JAN	FEB	MAR	APR	MAY	JUN	JUL	AUG	SEP	OCT	NOV	DEC
Pocket Picking	319	0.2%	19	38	46	26	18	31	21	26	23	26	23	22
Purse Snatching	682	0.3%	41	42	59	53	54	46	46	62	60	96	58	65
Shoplifting	38,509	19.0%	2,905	2,735	3,246	2,979	3,111	3,030	2,892	3,133	3,482	3,708	3,743	3,545
From Motor Vehicles	37,814	18.6%	3,242	2,937	3,480	3,156	3,125	2,908	3,082	2,902	3,024	3,538	3,357	3,063
Motor Vehicle Parts and/or Accessories	31,226	15.4%	2,695	2,494	2,765	2,517	2,559	2,448	2,692	2,610	2,655	2,621	2,747	2,423
Bicycles	15,443	7.6%	1,240	1,246	1,388	1,263	1,377	1,318	1,254	1,301	1,541	1,321	1,225	969
From Buildings	14,077	6.9%	1,044	1,010	1,152	1,113	1,111	1,023	1,197	1,423	1,248	1,363	1,244	1,149
From Coin Operated Machines	1,196	0.6%	122	150	94	156	127	83	77	76	62	69	85	95
All Other	63,608	31.4%	5,758	5,242	5,190	4,569	5,306	5,496	5,342	5,438	5,251	5,438	5,083	5,495
TOTAL	202,874	100.0%	17,066	15,894	17,420	15,832	16,788	16,383	16,603	16,971	17,346	18,180	17,565	16,826

LARCENY-THEFT BY VALUE BY MONTH

VALUE	TOTAL	DIST.	JAN	FEB	MAR	APR	MAY	JUN	JUL	AUG	SEP	OCT	NOV	DEC
Over \$200	68,801	33.9%	5,903	5,471	5,911	5,521	5,773	5,667	5,639	5,618	5,721	6,036	6,000	5,541
\$50 to \$200	38,303	18.9%	3,288	3,110	3,236	3,027	3,185	2,943	3,225	3,174	3,191	3,401	3,241	3,282
Under \$50	95,770	47.2%	7,875	7,313	8,273	7,284	7,830	7,773	7,739	8,179	8,434	8,743	8,324	8,003
TOTAL	202,874	100.0%	17,066	15,894	17,420	15,832	16,788	16,383	16,603	16,971	17,346	18,180	17,565	16,826

LARCENY-THEFT BY CLASSIFICATION & VALUE

CLASSIFICATION BY VALUE OF PROPERTY STOLEN	NUMBER OF OFFENSES	TOTAL VALUE STOLEN	AVERAGE VALUE	PERCENT DISTRIBUTION (VALUE)
\$200 and Over	68,801	\$78,822,366	1,146	93.4%
\$50 to \$200	38,303	4,073,440	106	4.3%
Under \$50	95,770	1,483,810	16	1.3%
TOTAL	202,874	\$84,379,616	\$416	100.0%

ADDITIONAL ANALYSIS

CLASSIFICATION	NUMBER OF OFFENSES	TOTAL VALUE STOLEN	AVERAGE VALUE	PERCENT DISTRIBUTION (VALUE)
Pocket Picking	319	\$90,932	\$285	0.1%
Purse Snatching	682	209,750	308	0.2%
Shoplifting	38,509	2,261,632	59	2.7%
From Motor Vehicles	37,814	17,378,192	460	20.5%
Motor Vehicle Parts and/or Accessories	31,226	9,381,975	300	11.1%
Bicycles	15,443	4,467,059	289	5.3%
From Buildings	14,077	9,009,367	640	10.7%
From Coin-Operated Machines	1,196	136,466	114	0.2%
All Other	63,608	41,444,243	652	49.1%
TOTAL	202,874	\$84,379,616	\$416	100.0%

MOTOR VEHICLE THEFT

DEFINITION

The unlawful taking or stealing of a motor vehicle including attempts and joyriding. This definition excludes the taking for temporary use by those persons having lawful access to the vehicle. For UCR purposes, a motor vehicle is defined as a self-propelled vehicle that runs on land and not on rails. Farm equipment, bulldozers, airplanes, construction equipment, and motorboats are excluded.

SUMMARY

- There were 48,019 motor vehicle thefts reported during 1995.
- Motor vehicle theft accounted for 14.1 percent of the total Index offenses and 15.5 percent of the property crimes.
- August recorded the highest number, with 4,623, while April recorded the lowest with 3,455.
- Autos represented the highest single category of motor vehicle theft, with 31,611, or 65.8 percent.
- The total dollar loss amounted to \$219,123,671. Of that amount, \$147,566,263 was recovered. The recovered amount reflects the value of the vehicle when recovered and may be lower than the value when stolen because of missing parts or damage.

ARRESTS/CLEARANCES

- A total of 3,823 persons were arrested in 1995.
- Adults accounted for 2,041 arrests and juveniles accounted for 1,782 arrests.
- Males accounted for 3,272 arrests, or 85.6 percent, and females accounted for 551 arrests, or 14.4 percent.
- There were 5,692 clearances for motor vehicle theft reported in 1995. Juveniles represented 24.1 percent of this total.

RECOVERED MOTOR VEHICLES

- Recovered motor vehicles that were locally stolen amounted to 33,266, or a 69.3 percent recovery rate. Of those, 23,856 were recovered locally, 8,462 were recovered by another jurisdiction in-state, and 948 were recovered out of state.
- Motor vehicles that were reported stolen out of state and recovered by Arizona agencies amounted to 805.

MOTOR VEHICLE THEFT BY MONTH

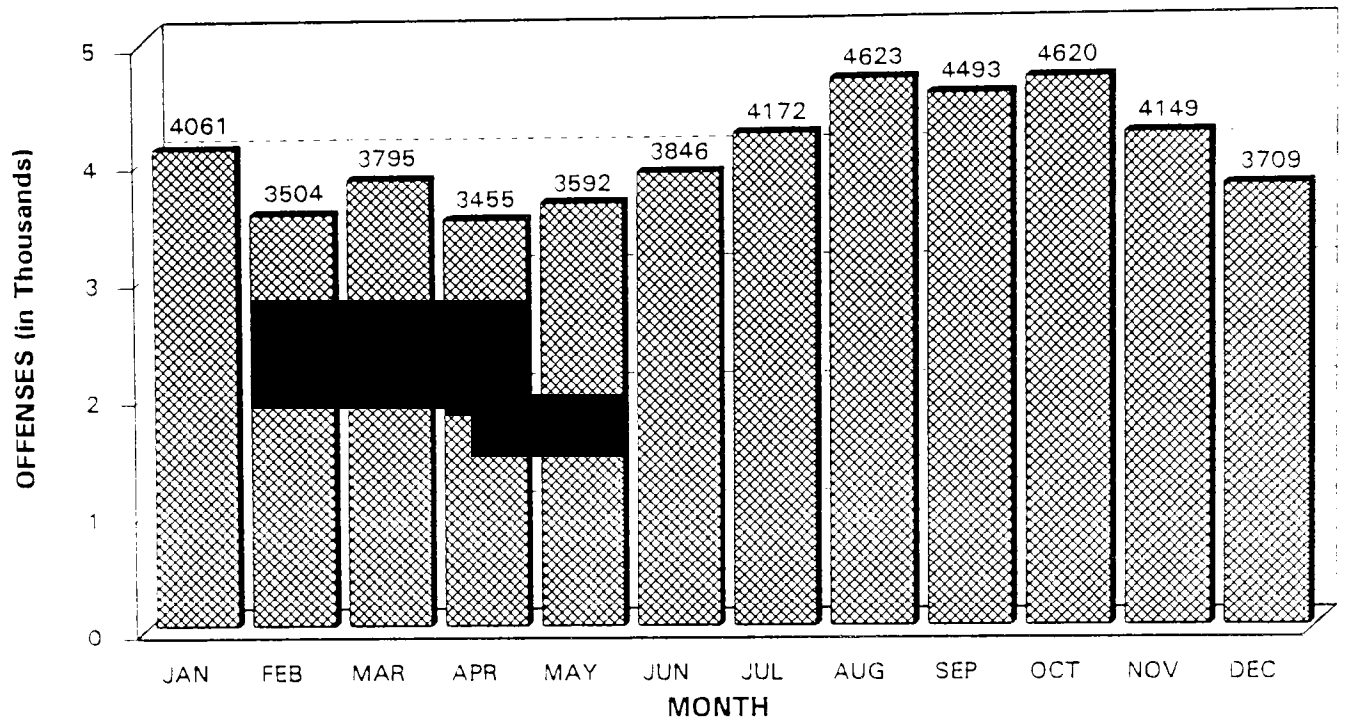

STOLEN VEHICLES BY TYPE

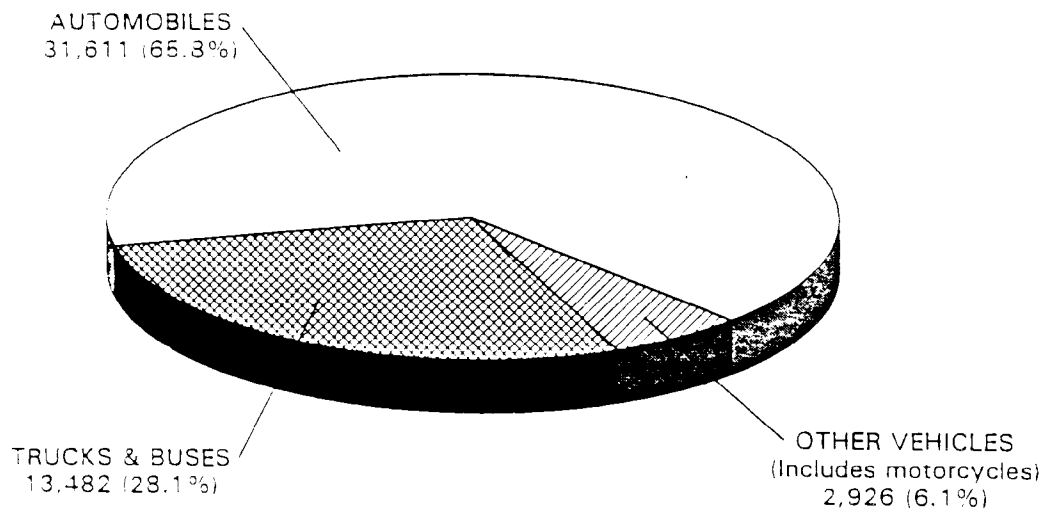

ARSON

DEFINITION

Arson is defined by the national Uniform Crime Reporting Program to include any willful or malicious burning or attempts to burn, with or without intent to defraud, a dwelling house, public building, motor vehicle or aircraft, personal property of another, etc. Fires of suspicious or unknown origins are excluded.

SUMMARY

- There were 1,532 arsons reported during 1995.
- Arson accounted for 0.5 percent of the total Index offenses and 0.5 percent of the property crimes.
- July recorded the highest number, with 156, while February recorded the lowest with 100.
- Structural arson accounted for 740 offenses or 48.3 percent.
- Motor vehicle arson accounted for the highest single known category, with 324, while industrial/manufacturing arson was the lowest with 6.
- The total estimated value of property damage amounted to \$7,140, 313.
- Single residence arson had the highest dollar loss with \$2,986,111.

ARRESTS/CLEARANCES

- A total of 463 persons were arrested in 1995.
- Adults accounted for 136 arrests and juveniles accounted for 327 arrests.
- Males accounted for 403 arrests, or 87.0 percent, and females accounted for 60 arrests, or 13.0 percent.
- There were 280 clearances for arson reported in 1995. Juveniles represented 54.3 percent of this total.

ARSON BY PROPERTY CLASSIFICATION

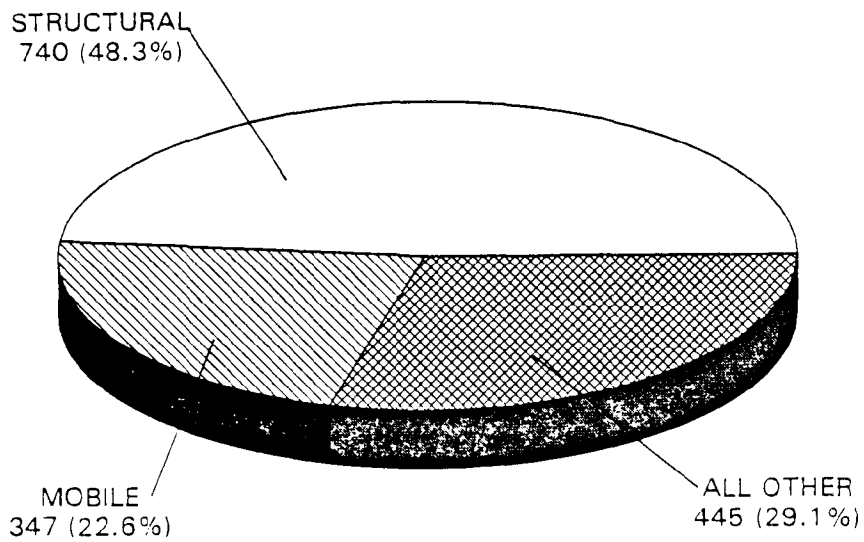

VALUE OF PROPERTY DAMAGED

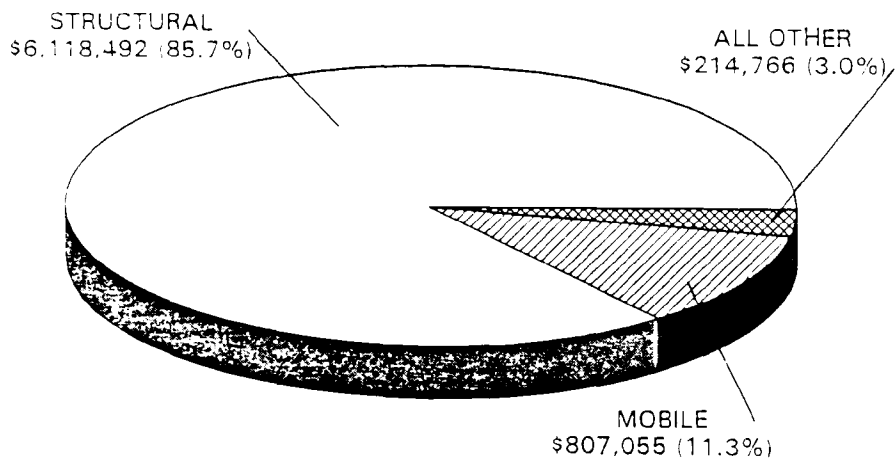

ARSON OFFENSES BY PROPERTY TYPE BY MONTH

PROPERTY CLASSIFICATION	TOTAL	JAN	FEB	MAR	APR	MAY	JUN	JUL	AUG	SEP	OCT	NOV	DEC	VALUE OF PROPERTY DAMAGE
STRUCTURE														
Single Occupancy Residential: Houses, Townhouses, Duplexes, Etc.	320	31	26	34	25	21	32	36	24	18	30	17	26	\$2,986,111
Other Residential: Apartments, Hotels, Motels, Dormitories, Etc.	124	10	7	12	11	12	7	8	12	10	12	15	8	713,775
Storage: Barns, Garages, Warehouses, Etc.	39	6	--	2	7	5	3	3	2	3	2	3	3	123,065
Industrial/Manufacturing	6	--	--	1	1	1	--	--	2	--	1	--	--	11,500
Other Commercial: Stores, Restaurants, Offices, Etc.	79	8	5	1	3	6	5	11	8	9	13	4	6	1,082,720
Community/Public: Churches, Jails, Schools, Etc.	98	16	13	10	9	13	6	6	7	4	5	4	5	925,121
All Other: Monuments, Buildings under Construction, Etc.	74	11	3	4	2	6	7	10	5	6	10	4	6	275,397
SUBTOTAL	740	82	54	64	58	64	60	74	60	50	73	47	54	\$6,118,492
MOBILE														
Motor Vehicles: Autos, Trucks, Buses, Motorcycles, Etc.	324	31	19	20	21	25	31	26	20	33	32	39	27	551,305
All Other: Trailers, Recreational Vehicles, Airplanes, Boats, Etc.	23	1	2	1	4	1	--	4	2	2	2	4	--	255,250
SUBTOTAL	347	32	21	21	25	26	31	30	22	35	34	43	27	\$807,055
ALL OTHER														
Crops, Timber, Fences, Signs, Etc.	445	33	25	25	35	62	46	52	32	21	32	41	41	214,766
TOTAL	1,532	147	100	110	118	152	137	156	114	106	139	131	122	\$7,140,313



**COUNTY
OFFENSE**

AND

SUPPLEMENTAL

DATA

INDEX CRIMES BY COUNTY

INDEX CRIMES	APACHE	COCHISE	COCONINO	GILA	GRAHAM	GREENLEE
MURDER	2	4	9	3	2	--
FORCIBLE RAPE	3	4	32	19	4	--
Rape by Force	2	4	28	19	4	--
Attempts to Commit	1	--	4	--	--	--
ROBBERY	4	30	51	8	--	--
Firearm	2	14	21	1	--	--
Knife/Cutting Instrument	--	4	3	1	--	--
Other Dangerous Weapons	--	5	5	1	--	--
Strong Arm	2	7	22	5	--	--
AGGRAVATED ASSAULT	55	193	398	209	125	3
Firearm	10	30	56	33	10	--
Knife/Cutting Instrument	7	13	45	20	6	--
Other Dangerous Weapons	15	30	82	110	14	--
Physical Force	23	120	215	46	95	3
BURGLARY	129	1,018	992	384	103	--
Forcible Entry	91	614	423	180	56	--
Unlawful Entry-No Force	34	299	444	120	46	--
Attempted Forcible Entry	4	105	125	84	1	--
LARCENY-THEFT	540	2,974	5,755	1,399	592	74
MOTOR VEHICLE THEFT	20	373	285	100	46	--
Autos	11	206	184	61	18	--
Trucks and Buses	8	130	52	14	9	--
Other Vehicles	1	37	49	25	19	--
ARSON	4	25	37	12	3	--
TOTAL	757	4,621	7,559	2,134	875	77

INDEX CRIMES BY COUNTY (CONT.)

LA PAZ	MARICOPA	MOHAVE	NAVAJO	PIMA	PINAL	SANTA CRUZ	YAVAPAI	YUMA
2	298	5	1	92	9	3	7	3
--	766	29	26	394	58	1	34	9
--	654	22	22	280	51	1	29	6
--	112	7	4	114	7	--	5	3
6	5,281	115	24	1,445	74	51	38	12
3	2,406	48	7	451	10	9	12	5
--	532	3	2	136	3	9	7	2
1	332	16	2	277	9	4	9	--
2	2,011	48	13	581	52	29	10	5
139	12,375	432	279	4,672	679	115	629	93
7	5,137	86	49	1,405	192	10	106	15
2	2,009	48	38	925	86	14	53	13
29	3,427	113	50	977	218	5	405	15
101	1,802	185	142	1,365	183	86	65	50
113	39,519	2,291	707	8,645	1,745	505	1,571	477
50	22,261	988	441	5,887	1,055	427	479	269
52	14,980	1,203	241	1,853	565	33	1,006	172
11	2,278	100	25	905	125	45	86	36
329	120,414	5,442	2,099	50,675	5,514	713	4,995	1,359
51	37,525	628	133	7,453	617	232	415	141
22	24,425	436	78	5,184	433	155	332	66
9	11,124	94	33	1,793	82	54	40	40
20	1,976	98	22	476	102	23	43	35
6	799	76	12	447	54	8	45	4
646	216,977	9,018	3,281	73,823	8,750	1,628	7,734	2,098

ANALYSIS OF ROBBERY, BURGLARY, AND LARCENY-THEFT BY COUNTY

OFFENSES	APACHE	COCHISE	COCONINO	GILA	GRAHAM	GREENLEE
ROBBERY	4	30	51	8	--	--
Highway	4	5	30	2	--	--
Commercial House	--	4	6	--	--	--
Gas or Service Station	--	1	1	1	--	--
Convenience Store	--	3	4	--	--	--
Residence	--	6	1	1	--	--
Bank	--	--	1	--	--	--
Miscellaneous	--	11	8	4	--	--
BURGLARY	129	1,018	992	384	103	--
Residence	77	652	604	244	62	--
Night, 6PM-6AM	6	178	135	80	36	--
Day, 6AM-6PM	17	251	196	133	13	--
Unknown	54	223	273	31	13	--
Non-Residence	52	366	388	140	41	--
Night, 6PM-6AM	25	193	148	43	29	--
Day, 6AM-6PM	12	72	86	80	--	--
Unknown	15	101	154	17	12	--
LARCENY-THEFT	540	2,974	5,755	1,399	592	74
\$200 and Over	138	707	2,041	443	207	41
\$50 to \$200	91	694	1,030	296	161	16
Under \$50	311	1,573	2,684	660	224	17
Pocket Picking	3	5	3	4	1	--
Purse Snatching	7	22	19	12	19	--
Shoplifting	49	597	1,044	262	162	10
From Motor Vehicle	63	387	1,037	227	95	--
Motor Vehicle Parts/Accessories	26	194	144	48	36	3
Bicycles	19	214	510	67	63	--
From Buildings	122	261	465	236	81	1
From Coin-Operated Machines	3	11	19	2	9	--
All Other	248	1,283	2,514	541	126	60
TOTAL	673	4,022	6,798	1,791	695	74

ANALYSIS OF ROBBERY, BURGLARY, AND LARCENY-THEFT BY COUNTY (CONT.)

LA PAZ	MARICOPA	MOHAVE	NAVAJO	PIMA	PINAL	SANTA CRUZ	YAVAPAI	YUMA
6	5,281	115	24	1,445	74	51	38	12
3	2,981	13	7	812	26	2	9	2
1	842	14	3	126	9	--	4	1
1	61	6	2	34	1	--	--	1
1	529	8	2	207	3	1	3	--
--	542	14	2	107	11	--	2	3
--	135	5	1	23	--	--	1	--
--	191	55	7	136	24	48	19	5
113	39,519	2,291	707	8,645	1,745	505	1,571	477
83	28,775	1,536	389	6,051	1,115	386	1,108	334
14	5,529	244	77	1,160	387	103	239	90
25	10,471	411	70	1,310	547	183	507	92
44	12,775	881	242	3,581	181	100	362	152
30	10,744	755	318	2,594	630	119	463	143
10	3,620	261	172	615	245	52	131	42
12	1,215	119	42	303	240	42	108	20
8	5,909	375	104	1,676	145	25	224	81
329	120,414	5,442	2,099	50,675	5,514	713	4,995	1,359
152	48,790	1,908	538	10,568	1,631	237	1,010	390
72	24,856	1,189	438	6,858	1,287	154	808	353
105	46,768	2,345	1,123	33,249	2,596	322	3,177	616
--	199	8	3	68	8	3	10	4
--	352	31	13	176	10	2	3	16
35	20,916	870	583	11,443	1,111	217	908	302
29	26,041	851	180	7,256	658	77	610	303
31	25,510	214	92	4,127	408	61	250	82
20	10,806	385	124	2,349	464	29	203	190
27	6,573	418	306	4,522	393	86	471	115
1	663	39	15	364	25	1	34	10
186	29,354	2,626	783	20,370	2,437	237	2,506	337
448	165,214	7,848	2,830	60,765	7,333	1,269	6,604	1,848

VALUE OF PROPERTY STOLEN BY OFFENSE BY COUNTY

OFFENSES	APACHE	COCHISE	COCONINO	GILA	GRAHAM	GREENLEE
MURDER	--	--	--	--	200	--
FORCIBLE RAPE	--	--	--	550	--	--
ROBBERY	1,020	62,436	18,708	1,251	--	--
Highway	1,020	316	10,841	435	--	--
Commercial House	--	5,907	1,740	--	--	--
Gas or Service Station	--	80	150	88	--	--
Convenience Store	--	68	1,078	--	--	--
Residence	--	54,256	500	--	--	--
Bank	--	--	--	--	--	--
Miscellaneous	--	1,809	4,399	728	--	--
BURGLARY	116,533	1,321,178	978,311	360,722	94,259	--
Residence	76,356	843,387	550,465	281,745	55,544	--
Night, 6PM-6AM	5,290	183,752	98,849	69,513	41,268	--
Day, 6AM-PM	11,609	416,574	190,513	168,919	7,832	--
Unknown	59,457	243,061	261,103	43,313	6,444	--
Non-Residence	40,177	477,791	427,846	78,977	38,715	--
Night, 6PM-6AM	16,964	164,110	253,710	19,093	24,950	--
Day, 6AM-6PM	7,582	136,865	66,531	51,343	--	--
Unknown	15,631	176,816	107,605	8,541	13,765	--
LARCENY-THEFT	143,853	936,976	1,988,874	581,545	263,782	47,476
\$200 and Over	129,397	841,381	1,819,403	544,018	242,973	45,541
\$50 to \$200	10,657	72,262	111,228	30,304	17,086	1,724
Under \$50	3,799	23,333	58,243	7,223	3,723	211
Pocket Picking	355	984	758	1,050	10	--
Purse Snatching	2,109	6,703	14,349	2,040	1,820	--
Shoplifting	2,092	20,313	66,617	10,217	6,298	301
From Motor Vehicle	22,269	126,394	389,856	95,450	34,838	--
Motor Vehicle Parts/Accessories	3,007	34,652	38,524	20,341	6,993	2,650
Bicycles	4,001	28,753	189,321	13,985	9,961	--
From Buildings	45,391	258,523	178,793	145,882	116,609	120
From Coin-Operated Machines	1,160	671	3,882	30	1,904	--
All Other	63,469	459,983	1,106,774	292,550	85,349	44,405
MOTOR VEHICLE THEFT	118,523	1,752,932	1,804,779	481,418	235,620	--
TOTAL	379,929	4,073,522	4,790,672	1,425,486	593,861	47,476

VALUE OF PROPERTY STOLEN BY OFFENSE BY COUNTY (CONT.)

LA PAZ	MARICOPA	MOHAVE	NAVAJO	PIMA	PINAL	SANTA CRUZ	YAVAPAI	YUMA
--	60,945	--	--	--	--	--	--	--
--	3,535	--	--	7,670	--	--	80	105
9,416	5,685,945	121,954	28,800	692,484	19,564	25,464	9,183	124,254
4,010	3,491,102	9,809	19,790	382,862	8,465	3,455	5,955	1,892
800	790,529	5,448	520	26,187	256	--	165	121,843
1	10,088	728	120	1,305	554	--	--	31
4,605	101,388	10,926	69	4,238	204	500	135	--
--	685,459	48,970	3,532	239,986	8,392	--	1,215	338
--	438,094	23,264	1,722	13,000	--	--	--	--
--	169,285	22,809	3,047	24,906	1,693	21,509	1,713	150
103,028	62,332,876	2,571,692	550,923	11,087,16	2,020,219	325,758	1,019,428	465,178
76,202	43,786,037	1,579,813	339,590	8,611,475	1,424,801	251,876	639,138	292,797
20,281	6,291,806	170,014	43,696	1,128,562	408,876	71,434	115,814	120,086
10,720	17,257,410	339,912	94,777	1,545,418	778,566	141,652	205,126	65,581
45,201	20,236,821	1,069,887	201,117	5,937,495	237,359	38,790	318,198	107,130
26,826	18,546,839	991,879	211,333	2,475,692	595,418	73,882	380,290	172,381
6,629	4,795,258	353,727	122,341	408,478	214,777	14,570	72,494	56,396
16,562	1,262,123	129,779	14,023	173,137	258,366	21,816	91,160	11,076
3,635	12,489,458	508,373	74,969	1,894,077	122,275	37,496	216,636	104,909
319,068	62,237,606	4,456,434	692,839	8,714,278	2,211,732	276,379	1,097,589	411,185
310,191	58,182,314	4,295,706	631,955	8,146,405	2,025,025	253,044	989,494	365,519
7,676	2,852,741	126,140	46,162	518,804	139,049	17,660	84,692	37,255
1,201	1,202,551	34,588	14,722	49,069	47,658	5,675	23,403	8,411
--	49,111	774	470	29,901	2,693	798	3,675	353
--	102,452	16,543	1,755	52,979	4,135	1,065	290	3,510
1,101	1,641,323	26,388	20,662	372,809	37,518	12,851	35,944	7,198
50,619	13,073,692	374,054	106,883	2,327,551	398,446	33,484	245,551	99,105
15,273	8,311,899	63,924	27,317	658,230	120,687	24,407	46,759	7,312
6,495	3,281,623	113,944	22,278	617,843	80,633	6,870	63,874	27,478
19,378	5,328,014	307,231	144,039	1,838,390	264,355	39,487	270,195	52,960
4	85,853	5,706	2,226	26,270	3,934	31	3,517	1,278
226,198	30,363,639	3,547,870	367,209	2,790,305	1,299,331	157,386	427,784	211,991
75,395	180,701,61	2,141,586	709,415	25,782,21	3,460,982	1,622,791	1,109,931	426,921
506,907	311,022,52	9,291,666	1,981,977	46,283,80	7,712,497	2,250,392	3,236,211	1,427,643

TYPE AND VALUE, IN DOLLARS, OF PROPERTY STOLEN AND RECOVERED

STOLEN	APACHE	COCHISE	COCONINO	GILA	GRAHAM	GREENLEE
Currency/Notes/Etc.	15,371	443,784	352,053	74,228	19,589	3,916
Jewelry/Precious Metals	19,964	347,948	386,113	157,282	29,036	1,930
Clothing and Furs	1,969	64,999	137,157	18,817	1,198	364
Locally Stolen Vehicles	117,824	1,667,835	1,806,172	463,518	237,120	--
Office Equipment	4,516	148,532	74,123	9,587	28,672	120
Stereos/TV's/Cameras	27,563	305,992	405,715	132,389	56,803	4,400
Firearms	17,143	99,780	83,785	63,845	11,434	2,250
Household Goods	39,452	55,192	91,139	48,642	17,848	--
Consumable Goods	9,604	46,001	77,542	5,566	3,159	185
Livestock	4,819	2,879	3,535	975	1,122	--
Miscellaneous	121,704	890,580	1,373,338	450,637	187,880	34,311
TOTAL STOLEN	379,929	4,073,522	4,790,672	1,425,486	593,861	47,476
RECOVERED						
Currency/Notes/Etc.	4,357	26,249	34,495	3,053	9,161	170
Jewelry/Precious Metals	13,430	21,384	36,638	13,138	1,287	30
Clothing and Furs	510	6,642	93,634	1,238	676	337
Locally Stolen Vehicles	61,575	733,619	952,634	359,378	211,440	--
Office Equipment	175	5,654	721	97	12,260	--
Stereos/TV's/Cameras	6,751	29,129	18,848	13,231	12,437	--
Firearms	5,200	5,789	9,993	5,124	2,690	--
Household Goods	5,200	4,333	7,121	11,995	6,930	--
Consumable Goods	501	5,092	4,464	1,955	1,777	8
Livestock	609	--	1,650	--	565	--
Miscellaneous	21,563	62,914	146,387	67,789	12,482	2,688
TOTAL RECOVERED	119,871	900,805	1,306,585	476,998	271,705	3,233

TYPE AND VALUE, IN DOLLARS, OF PROPERTY STOLEN AND RECOVERED (CONT.)

LA PAZ	MARICOPA	MOHAVE	NAVAJO	PIMA	PINAL	SANTA CRUZ	YAVAPAI	YUMA
32,435	7,064,905	479,518	259,936	1,114,422	374,727	55,976	160,074	176,721
47,611	20,626,055	567,516	138,235	4,597,502	477,541	104,217	292,577	71,037
8,614	3,921,255	116,035	18,957	718,285	85,661	28,625	60,403	8,180
79,406	179,941,492	2,459,004	735,081	25,710,030	2,922,248	1,452,491	1,139,884	391,566
5,520	12,088,036	114,607	39,057	1,174,342	96,787	17,519	85,557	2,422
47,875	23,579,948	613,416	196,561	4,260,400	580,390	105,172	315,361	134,349
5,810	2,865,206	156,084	45,651	633,366	168,688	185,299	112,373	25,040
27,705	5,535,578	280,638	71,338	924,382	186,004	17,748	82,718	20,853
4,619	1,129,264	167,106	17,351	109,801	43,136	4,778	23,609	12,951
--	2,732,698	770	175	59,857	8,227	9,000	8,619	1,250
247,312	51,538,083	4,336,972	459,635	6,981,422	2,769,088	269,567	955,036	583,274
506,907	311,022,520	9,291,666	1,981,977	46,283,809	7,712,497	2,250,392	3,236,211	1,427,643
880	303,827	32,427	8,290	25,109	64,344	1,124	6,553	122,934
--	653,942	48,340	31,488	158,614	37,877	4,776	21,272	828
850	448,099	9,783	4,213	95,196	14,159	10,090	4,756	656
30,906	129,446,100	1,881,698	514,777	10,147,511	2,228,354	180,605	777,788	39,878
5	542,445	15,478	2,598	31,489	459	1,925	21,367	1,072
1,681	826,743	57,192	16,480	134,337	34,205	2,874	24,622	5,515
375	256,384	25,606	3,875	79,093	14,362	132,849	16,910	1,756
2,696	257,316	22,588	19,016	20,733	12,886	506	4,023	200
35	224,031	21,566	4,142	21,807	9,908	857	6,032	751
--	80	250	368	1,490	6,050	8,200	--	385
22,271	5,472,178	1,665,953	83,006	264,010	543,140	11,728	94,064	82,476
59,699	138,431,145	3,780,881	688,253	10,979,389	2,965,744	355,534	977,387	256,451



**STATE
ARREST
DATA**

ARREST SUMMARY

- There were 301,497 arrests reported in 1995.
- Arrests for Part I offenses amounted to 61,649, or 20.4 percent.
- Arrests for Part II offenses amounted to 239,848, or 79.6 percent.
- Adult arrests were 232,755, or 77.2 percent, and juvenile arrests were 68,742, or 22.8 percent.
- Males accounted for 236,695 arrests, or 78.5 percent, and females accounted for 64,802, or 21.5 percent.
- Arrests for adults between the ages of 25-29 recorded the highest number with 42,175, or 18.1 percent of the total adult arrests.
- Arrests for juveniles age 12 and under were 7,078, or 10.3 percent of the total juvenile arrests.
- Larceny-theft recorded the highest number of arrests of a specific offense with 41,233, or 13.7 of the total.

ARREST BY AGE GROUP

PART 1 OFFENSES	ADULT ARRESTS		JUVENILE ARRESTS	
	MALE	FEMALE	MALE	FEMALE
Criminal Homicide	239	25	41	2
Forcible Rape	225	--	41	--
Robbery	1,011	101	470	83
Aggravated Assault	5,147	845	1,431	294
Burglary	3,315	289	2,349	222
Larceny-Theft	20,617	8,461	8,269	3,886
Motor Vehicle Theft	1,786	255	1,486	296
Arson	117	19	286	41
TOTAL	32,457	9,995	14,373	4,824

TOTAL ARRESTS BY OFFENSE, RACE & ETHNIC ORIGIN

OFFENSE CLASSIFICATION	NUMBER OF ARRESTS	DIST.	WHITE	BLACK	INDIAN	ASIAN	HISPANIC	NCN HISPANIC
PART I								
Murder/Nonneg. Manslaughter	307	0.10%	265	31	9	2	114	193
Forcible Rape	266	0.09%	215	45	6	--	98	168
Robbery	1,665	0.55%	1,136	452	71	6	627	1,038
Aggravated Assault	7,717	2.56%	6,426	868	372	51	2,393	5,324
Burglary	6,175	2.05%	5,305	632	200	38	1,982	4,293
Larceny-Theft	41,233	13.68%	34,599	4,159	2,207	268	11,545	29,688
Motor Vehicle Theft	3,823	1.27%	3,251	395	162	15	1,489	2,334
Arson	463	0.15%	431	21	3	3	77	386
PART I SUBTOTAL	61,649	20.45%	51,628	6,603	3,035	383	18,225	43,424
PART II								
Manslaughter by Negligence	50	0.02%	43	2	4	1	16	34
Other Assaults - Simple	30,380	10.08%	25,387	3,062	1,759	172	9,385	21,496
Forgery and Counterfeiting	2,241	0.74%	2,020	171	30	20	434	1,807
Fraud	1,923	0.64%	1,638	240	34	11	275	1,648
Embezzlement	220	0.07%	197	17	5	1	47	179
Stolen Property	3,990	1.32%	3,467	413	92	18	1,259	2,731
Vandalism	10,734	3.56%	9,301	879	491	63	3,151	7,583
Weapons: Carrying, Possessing, Etc.	4,937	1.64%	4,248	609	62	18	1,922	3,115
Prostitution and Comm. Vice	1,835	0.61%	1,410	365	50	10	312	1,523
Sex Offenses	2,179	0.72%	1,856	176	139	8	471	1,708
DRUGS, SALE OR MFG.								
Opium, Cocaine, Derivatives	1,353	0.45%	1,116	228	6	3	726	927
Marijuana	1,455	0.48%	1,333	66	53	3	528	927
Synthetic Narcotics	598	0.20%	510	82	6	--	119	479
Other Dangerous Nonnarcotics	2,078	0.69%	1,995	57	20	6	292	1,786
DRUGS, POSSESSION								
Opium, Cocaine, Derivatives	1,925	0.64%	1,573	318	31	3	743	1,182
Marijuana	12,040	3.99%	10,791	827	367	55	3,722	8,318
Synthetic Narcotics	1,998	0.66%	1,822	139	32	5	486	1,512
Other Dangerous Nonnarcotics	3,277	1.09%	2,888	295	79	15	731	2,546
All Gambling								
All Gambling	37	0.01%	29	6	2	--	7	30
Offenses Against Family/Children								
Offenses Against Family/Children	2,315	0.77%	2,004	122	174	15	391	1,924
Driving Under the Influence								
Driving Under the Influence	28,196	9.35%	25,055	691	2,340	110	7,970	20,326
Liquor Law Violations								
Liquor Law Violations	22,237	7.38%	18,801	1,028	2,344	64	6,119	16,118
Disorderly Conduct								
Disorderly Conduct	23,773	7.88%	19,931	1,975	1,749	118	6,089	17,684
Vagrancy								
Vagrancy	709	0.24%	397	54	257	1	81	628
All Other, Except Traffic								
All Other, Except Traffic	62,297	20.66%	52,714	5,503	3,856	224	15,450	46,847
Curfew/Loitering (Juveniles)								
Curfew/Loitering (Juveniles)	8,670	2.87%	7,960	537	192	81	4,006	4,664
Runaways (Juveniles)								
Runaways (Juveniles)	3,401	2.79%	2,657	499	170	75	2,044	6,357
PART II SUBTOTAL	239,848	79.55%	206,043	18,361	14,344	1,100	66,076	173,772
TOTAL	301,497	100.00%	257,671	24,964	17,379	1,483	84,301	217,196

JUVENILE ARRESTS BY OFFENSE, RACE & ETHNIC ORIGIN

OFFENSE CLASSIFICATION	NUMBER OF ARRESTS	DIST.	WHITE	BLACK	INDIAN	ASIAN	HISPANIC	NON HISPANIC
PART I								
Murder/Nonneg. Manslaughter	43	0.06%	38	4	1	--	25	19
Forcible Rape	41	0.06%	37	4	--	--	16	25
Robbery	553	0.81%	407	124	19	3	239	314
Aggravated Assault	1,725	2.51%	1,450	205	62	8	637	1,088
Burglary	2,571	3.74%	2,259	184	112	16	790	1,781
Larceny-Theft	12,155	17.68%	10,272	1,146	644	93	3,323	8,832
Motor Vehicle Theft	1,782	2.59%	1,500	169	107	6	817	965
Arson	327	0.48%	306	17	1	3	50	277
PART I SUBTOTAL	19,197	27.93%	16,269	1,853	946	129	5,897	13,300
PART II								
Manslaughter by Negligence	3	0.01%	3	--	--	--	2	1
Other Assaults - Simple	5,018	7.30%	4,265	567	162	24	1,542	3,476
Forgery and Counterfeiting	141	0.21%	120	18	3	--	39	102
Fraud	135	0.20%	112	17	3	3	28	107
Embezzlement	33	0.05%	30	2	1	--	11	22
Stolen Property	960	1.40%	766	146	44	4	395	565
Vandalism	4,026	5.86%	3,599	261	147	19	1,418	2,608
Weapons: Carrying, Possessing, Etc.	966	1.41%	830	110	22	4	425	541
Prostitution and Comm. Vice	23	0.03%	19	3	--	1	3	15
Sex Offenses	333	0.48%	299	23	10	1	81	252
DRUGS, SALE OR MFG.								
Opium, Cocaine, Derivatives	148	0.21%	138	9	1	--	62	36
Marijuana	275	0.40%	232	12	31	--	109	166
Synthetic Narcotics	56	0.08%	50	4	2	--	7	49
Other Dangerous Nonnarcotics	147	0.21%	136	7	4	--	38	109
DRUGS, POSSESSION								
Opium, Cocaine, Derivatives	134	0.19%	110	19	5	--	49	35
Marijuana	3,118	4.54%	2,801	199	104	14	1,125	1,993
Synthetic Narcotics	205	0.30%	181	8	15	1	53	152
Other Dangerous Nonnarcotics	300	1.16%	229	37	29	5	307	493
All Gambling	7	0.01%	6	1	--	--	1	5
Offenses Against Family/Children	127	0.18%	108	17	2	--	13	114
Driving Under the Influence	270	0.39%	246	2	21	1	94	176
Liquor Law Violations	4,751	6.91%	4,244	109	387	11	1,345	3,406
Disorderly Conduct	4,392	6.39%	3,804	401	174	13	1,508	2,884
Vagrancy	75	0.11%	64	5	6	--	19	56
All Other, Except Traffic	6,331	9.21%	5,773	327	207	24	1,742	4,589
Curfew/Loitering (Juveniles)	3,670	12.61%	7,860	537	192	81	4,006	4,664
Runaways (Juveniles)	3,401	12.22%	7,657	499	170	75	2,044	6,357
PART II SUBTOTAL	49,545	72.07%	44,182	3,340	1,742	281	16,471	33,074
TOTAL	68,742	100.00%	60,451	5,193	2,688	410	22,368	46,374

ADULT ARRESTS BY OFFENSE, RACE & ETHNIC ORIGIN

OFFENSE CLASSIFICATION	NUMBER OF ARRESTS	DIST.	WHITE	BLACK	NDIAN	ASIAN	HISPANIC	NON HISPANIC
PART I								
Murder/Nonneg. Manslaughter	264	0.11%	227	27	8	2	39	175
Forcible Rape	225	0.10%	178	41	6	--	32	143
Robbery	1,112	0.48%	729	328	52	3	388	724
Aggravated Assault	5,992	2.57%	4,976	663	310	43	1,756	4,236
Burglary	3,604	1.55%	3,046	448	88	22	1,092	2,512
Larceny-Theft	29,078	12.49%	24,327	3,013	1,563	175	3,222	20,856
Motor Vehicle Theft	2,041	0.88%	1,751	226	55	9	672	1,369
Arson	136	0.06%	125	4	7	--	27	109
PART I SUBTOTAL	42,452	18.24%	35,359	4,750	2,089	254	12,328	30,124
PART II								
Manslaughter by Negligence	47	0.02%	40	2	4	1	14	38
Other Assaults - Simple	25,362	10.90%	21,122	2,495	1,597	148	7,343	18,019
Forgery and Counterfeiting	2,100	0.90%	1,900	153	27	20	395	1,705
Fraud	1,788	0.77%	1,526	223	31	8	247	1,541
Embezzlement	187	0.08%	167	15	4	1	36	151
Stolen Property	3,030	1.30%	2,701	267	48	14	864	2,166
Vandalism	6,708	2.98%	5,702	618	344	44	1,733	4,075
Weapons: Carrying, Possessing, Etc.	3,971	1.71%	3,418	499	40	14	1,397	2,574
Prostitution and Comm. Vice	1,812	0.78%	1,391	362	50	9	304	1,508
Sex Offenses	1,846	0.79%	1,557	153	129	7	390	1,456
DRUGS, SALE OR MFG.								
Opium, Cocaine, Derivatives	1,205	0.52%	978	219	5	3	664	541
Marijuana	1,180	0.51%	1,101	54	22	3	419	761
Synthetic Narcotics	542	0.23%	460	78	4	--	112	430
Other Dangerous Nonnarcotics	1,931	0.83%	1,859	50	16	6	254	1,677
DRUGS, POSSESSION								
Opium, Cocaine, Derivatives	1,791	0.77%	1,463	299	26	3	694	1,097
Marijuana	8,922	3.83%	7,990	628	263	41	2,597	6,325
Synthetic Narcotics	1,793	0.77%	1,641	131	17	4	433	1,360
Other Dangerous Nonnarcotics	2,477	1.06%	2,159	258	50	10	424	2,053
All Gambling	30	0.01%	23	5	2	--	6	24
Offenses Against Family/Children	2,188	0.94%	1,896	105	172	15	378	1,810
Driving Under the Influence	27,926	12.00%	24,809	689	2,319	109	7,776	20,150
Liquor Law Violations	17,486	7.51%	14,557	919	1,957	53	4,774	12,712
Disorderly Conduct	19,381	8.33%	16,127	1,574	1,575	105	4,581	14,800
Vagrancy	634	0.27%	333	49	251	1	62	572
All Other, Except Traffic	55,966	24.05%	46,941	5,176	3,649	200	13,708	42,258
Curfew/Loitering (Juveniles)	--	--	--	--	--	--	--	--
Runaways (Juveniles)	--	--	--	--	--	--	--	--
PART II SUBTOTAL	190,303	81.76%	161,861	15,021	12,602	819	49,605	140,698
TOTAL	232,755	100.00%	197,220	19,771	14,691	1,073	61,933	170,822

TOTAL ARRESTS BY AGE

OFFENSE CLASSIFICATION	UNDER 10	10-12	13-14	15	16	17	TOTAL UNDER 18	18	19	20	21
PART I											
Murder/Nonneg. Manslaughter	--	2	5	6	15	15	43	16	25	18	14
Forcible Rape	--	8	12	5	7	9	41	14	11	9	3
Robbery	3	25	107	92	153	173	553	128	105	64	62
Aggravated Assault	41	204	412	314	353	401	1,725	355	271	258	248
Burglary	67	276	709	486	524	509	2,571	377	273	176	154
Larceny-Theft	308	1,776	3,793	2,222	2,068	1,988	12,155	2,030	1,633	1,292	1,066
Motor Vehicle Theft	--	86	482	461	417	336	1,782	249	173	141	103
Arson	55	106	94	31	22	19	327	11	14	2	3
PART I SUBTOTAL	474	2,483	5,614	3,617	3,559	3,450	19,197	3,180	2,505	1,960	1,658
PART II											
Manslaughter by Negligence	--	--	2	--	--	1	3	3	2	--	5
Other Assaults - Simple	116	655	1,501	917	932	897	5,018	701	925	353	941
Forgery and Counterfeiting	1	4	11	27	39	59	141	71	105	107	113
Fraud	--	--	19	35	41	40	135	45	70	30	62
Embezzlement	--	3	8	2	7	13	33	9	9	7	6
Stolen Property	1	42	226	224	234	233	960	256	203	156	141
Vandalism	205	615	1,144	776	700	586	4,026	455	321	303	291
Weapons: Carrying, Possessing, Etc.	6	35	201	168	241	315	966	361	295	277	251
Prostitution and Comm. Vice	--	--	3	7	5	8	23	42	50	44	68
Sex Offenses	5	51	117	77	42	41	333	47	50	71	53
DRUGS, SALE OR MFG.											
Opium, Cocaine, Derivatives	3	3	29	27	31	55	148	62	60	59	63
Marijuana	--	18	98	53	56	50	275	30	91	60	63
Synthetic Narcotics	--	--	18	10	16	12	56	24	20	18	21
Other Dangerous Nonnarcotics	--	3	37	35	38	34	147	53	55	43	69
DRUGS, POSSESSION											
Opium, Cocaine, Derivatives	2	6	29	20	34	43	134	61	68	80	70
Marijuana	3	135	742	671	769	793	3,118	909	811	616	524
Synthetic Narcotics	--	3	44	40	54	64	205	62	67	77	84
Other Dangerous Nonnarcotics	2	40	195	196	201	166	800	187	146	118	95
All Gambling	--	1	1	1	2	2	7	2	2	1	2
Offenses Against Family/Children	3	10	44	22	28	20	127	84	67	74	75
Driving Under the Influence	1	1	4	22	66	176	270	432	665	756	1,067
Liquor Law Violations	4	42	495	318	1,334	2,058	4,751	3,027	2,804	2,256	530
Disorderly Conduct	43	402	1,322	906	893	826	4,392	863	786	784	819
Vagrancy	1	5	17	11	16	25	75	30	31	20	17
All Other, Except Traffic	118	465	1,681	1,345	1,376	1,346	6,331	2,194	2,443	2,455	2,467
Curtew/Loitering (Juvenile)	43	357	2,181	2,111	2,064	1,914	8,670	--	--	--	--
Runaways (Juvenile)	52	611	2,845	2,077	1,787	1,029	8,401	--	--	--	--
PART I SUBTOTAL	614	3,507	13,014	10,598	11,006	10,806	49,545	10,060	10,036	9,315	7,892
TOTAL	1,088	5,990	18,628	14,215	14,565	14,256	68,742	13,240	12,541	11,275	9,550

TOTAL ARRESTS BY AGE (CONT.)

22	23	24	25-29	30-34	35-39	40-44	45-49	50-54	55-59	60-64	65 AND OVER	TOTAL OVER '8	TOTAL ALL AGES
8	12	21	44	36	29	19	9	3	4	.	--	264	307
8	12	11	46	43	31	14	10	4	2	.	.	225	266
45	55	35	225	182	115	56	25	10	2	.	2	1,112	1,665
248	252	211	1,042	1,090	882	585	256	138	62	43	51	5,992	7,717
153	166	150	665	626	430	258	107	38	12	14	5	3,604	6,175
1,041	1,047	976	4,791	5,119	4,262	2,739	1,376	707	332	261	406	29,078	41,233
111	98	100	390	326	201	88	41	9	5	3	3	2,041	3,823
3	4	6	20	17	15	18	11	3	4	.	4	136	463
1,617	1,646	1,510	7,223	7,439	5,965	3,777	1,835	917	423	325	472	42,452	61,649
2	2	1	9	6	12	.	.	3	--	--	--	47	60
948	1,020	1,111	5,122	5,374	4,103	2,242	1,096	491	208	152	175	25,362	30,360
120	82	119	419	437	290	147	48	20	8	3	6	2,100	2,241
59	59	69	368	361	306	142	32	41	20	13	11	1,788	1,923
13	6	10	50	32	24	12	7	--	1	--	1	187	220
154	158	143	671	505	359	176	70	17	14	2	5	3,030	3,990
278	297	282	1,351	1,250	914	492	238	113	64	25	34	6,708	10,734
213	197	184	765	577	385	242	119	66	21	7	11	3,971	4,937
66	67	80	436	392	320	142	50	15	15	7	18	1,812	1,935
46	57	56	284	340	306	202	141	79	54	33	27	1,846	2,179
74	71	46	260	206	149	76	43	17	10	6	3	1,205	1,353
68	48	55	212	201	146	38	50	14	3	1	--	1,190	1,455
24	20	19	113	113	93	53	23	7	1	1	2	542	598
53	81	75	450	486	309	184	47	17	4	3	2	1,931	2,079
82	63	74	369	339	293	183	74	26	6	1	2	1,791	1,925
447	411	435	1,640	1,362	919	533	197	77	22	11	3	3,922	12,040
77	59	67	408	382	282	149	55	14	7	1	2	1,793	1,998
107	102	118	485	489	360	184	64	19	5	1	7	2,477	3,277
1	2	1	2	1	--	4	3	2	3	3	1	30	37
80	75	62	416	448	374	226	112	39	24	17	15	2,188	2,315
1,037	1,090	1,246	5,288	4,978	4,109	3,007	1,869	1,115	567	329	371	27,926	29,196
413	328	330	1,381	1,483	1,618	1,308	885	496	313	136	178	17,486	22,237
831	727	807	3,456	3,430	2,895	1,852	1,054	469	264	161	183	19,381	23,773
16	12	18	67	101	104	100	40	32	14	18	14	634	709
2,418	2,364	2,419	10,930	10,569	8,103	4,760	2,360	1,138	638	319	389	55,966	62,297
--	--	--	--	--	--	--	--	--	--	--	--	--	8,670
--	--	--	--	--	--	--	--	--	--	--	--	--	8,401
7,627	7,398	7,837	34,952	33,862	26,763	16,505	8,728	4,327	2,286	1,250	1,465	190,303	239,848
9,244	9,044	9,347	42,175	41,301	32,728	20,282	10,563	5,244	2,709	1,575	1,937	232,755	301,497

JUVENILE MALE ARRESTS

OFFENSE CLASSIFICATION	AGE						TOTAL ARRESTS
	UNDER 10	10-12	13-14	15	16	17	
PART I							
Murder/Nonneg. Manslaughter	--	1	4	6	15	15	41
Forcible Rape	--	8	12	5	7	9	41
Robbery	3	19	84	74	134	156	470
Aggravated Assault	37	176	321	253	284	360	1,431
Burglary	60	238	633	447	487	484	2,349
Larceny-Theft	239	1,195	2,479	1,508	1,424	1,424	8,269
Motor Vehicle Theft	--	70	369	379	363	305	1,486
Arson	49	99	80	25	16	17	286
PART I SUBTOTAL	388	1,806	3,982	2,697	2,730	2,770	14,373
PART II							
Manslaughter by Negligence	--	--	2	--	--	1	3
Other Assaults - Simple	102	493	919	594	635	658	3,401
Forgery and Counterfeiting	1	3	6	15	29	45	99
Fraud	--	--	10	20	26	30	86
Embezzlement	--	3	7	2	6	10	28
Stolen Property	1	33	171	191	203	212	911
Vandalism	189	538	966	680	603	525	3,501
Weapons: Carrying, Possessing, Etc.	6	32	190	156	220	303	907
Prostitution and Comm. Vice	--	--	2	--	3	3	8
Sex Offenses	5	49	107	76	36	38	311
DRUGS, SALE OR MFG.							
Opium, Cocaine, Derivatives	2	2	21	24	25	47	121
Marijuana	--	12	78	44	47	43	224
Synthetic Narcotics	--	--	14	9	16	11	50
Other Dangerous Nonnarcotics	--	3	23	23	27	29	105
DRUGS, POSSESSION							
Opium, Cocaine, Derivatives	1	5	25	14	28	40	113
Marijuana	6	30	538	550	644	689	2,517
Synthetic Narcotics	--	3	38	34	42	52	169
Other Dangerous Nonnarcotics	1	30	146	144	156	134	611
All Gambling	--	1	--	1	2	1	5
Offenses Against Family/Children	3	3	24	12	20	12	79
Driving Under the Influence	1	1	3	19	55	146	225
Liquor Law Violations	4	24	277	540	981	1,571	3,397
Disorderly Conduct	37	265	881	645	648	631	3,107
Vagrancy	1	3	13	6	10	20	53
All Other, Except Traffic	37	359	1,204	1,008	1,069	1,098	4,825
Curfew/Loitering	32	205	1,348	1,371	1,430	1,388	5,774
Runaways	40	306	1,115	928	792	545	3,726
PART II SUBTOTAL	519	2,468	8,128	7,106	7,753	8,282	34,256
TOTAL	907	4,274	12,110	9,803	10,483	11,052	48,629

JUVENILE FEMALE ARRESTS

OFFENSE CLASSIFICATION	AGE						TOTAL ARRESTS
	UNDER 10	10-12	13-14	15	16	17	
PART I							
Murder/Nonneg. Manslaughter	--	1	1	--	--	--	2
Forcible Rape	--	--	--	--	--	--	--
Robbery	--	6	23	18	19	17	83
Aggravated Assault	4	28	91	61	69	41	294
Burglary	7	38	76	39	37	25	222
Larceny-Theft	69	581	1,314	714	644	564	3,866
Motor Vehicle Theft	--	16	113	32	54	31	296
Arson	6	7	14	6	6	2	41
PART I SUBTOTAL	86	677	1,632	920	929	680	4,324
PART II							
Manslaughter by Negligence	--	--	--	--	--	--	--
Other Assaults - Simple	14	162	582	323	297	239	1,617
Forgery and Counterfeiting	--	1	5	2	10	14	42
Fraud	--	--	9	15	15	10	49
Embezzlement	--	--	1	--	1	3	5
Stolen Property	--	9	55	33	31	21	149
Vandalism	16	77	178	96	97	61	625
Weapons: Carrying, Possessing, Etc.	--	3	11	12	21	12	59
Prostitution and Comm. Vice	--	--	1	7	2	5	15
Sex Offenses	--	2	10	1	6	3	22
DRUGS, SALE OR MFG.							
Opium, Cocaine, Derivatives	1	1	8	3	6	8	27
Marijuana	--	6	20	9	9	7	51
Synthetic Narcotics	--	--	4	1	--	1	6
Other Dangerous Nonnarcotics	--	--	14	12	11	5	42
DRUGS, POSSESSION							
Opium, Cocaine, Derivatives	1	1	4	6	6	3	21
Marijuana	2	45	204	121	125	104	601
Synthetic Narcotics	--	--	6	6	12	12	36
Other Dangerous Nonnarcotics	1	10	49	52	45	32	189
All Gambling	--	--	1	--	--	1	2
Offenses Against Family/Children	--	2	20	10	8	8	48
Driving Under the Influence	--	--	1	3	11	30	45
Liquor Law Violations	--	18	218	278	353	487	1,354
Disorderly Conduct	6	137	441	261	245	195	1,285
Vagrancy	--	2	4	5	6	5	22
All Other, Except Traffic	31	106	477	337	307	248	1,506
Curfew/Loitering	11	152	833	740	634	526	2,896
Runaways	12	305	1,730	1,149	995	484	4,675
PART II SUBTOTAL	95	1,039	4,886	3,492	3,253	2,524	15,289
TOTAL	181	1,716	6,518	4,412	4,082	3,204	20,113

ADULT MALE ARRESTS

OFFENSE CLASSIFICATION	AGE						
	18	19	20	21	22	23	24
PART I							
Murder/Nonneg. Manslaughter	15	25	14	14	7	11	20
Forcible Rape	14	11	9	8	8	12	11
Robbery	124	101	59	57	36	47	33
Aggravated Assault	325	243	222	220	225	206	192
Burglary	354	267	166	148	134	158	138
Larceny-Theft	1,497	1,189	900	749	764	779	680
Motor Vehicle Theft	229	150	125	93	99	90	91
Arson	10	13	2	2	2	4	6
PART I SUBTOTAL	2,568	1,999	1,497	1,291	1,275	1,307	1,171
PART II							
Manslaughter by Negligence	3	2	--	5	1	2	1
Other Assaults - Simple	556	647	673	750	772	338	596
Forgery and Counterfeiting	48	82	75	78	83	60	90
Fraud	36	48	50	31	39	40	50
Embezzlement	3	7	6	2	11	4	7
Stolen Property	237	183	138	120	144	132	123
Vandalism	409	278	262	245	240	248	233
Weapons: Carrying, Possessing, Etc.	350	285	259	238	202	178	174
Prostitution and Comm. Vice	7	5	4	7	12	10	16
Sex Offenses	41	44	64	47	38	48	51
DRUGS, SALE OR MFG.							
Opium, Cocaine, Derivatives	56	56	56	55	65	65	42
Marijuana	73	72	52	58	57	43	57
Synthetic Narcotics	23	18	16	16	19	19	19
Other Dangerous Nonnarcotics	43	43	33	59	34	63	61
DRUGS, POSSESSION							
Opium, Cocaine, Derivatives	53	58	66	65	68	51	60
Marijuana	305	716	535	461	385	364	386
Synthetic Narcotics	53	55	59	67	58	48	54
Other Dangerous Nonnarcotics	162	122	98	68	32	31	30
All Gambling	2	1	1	2	1	1	1
Offenses Against Family/Children	51	46	47	51	59	51	45
Driving Under the Influence	379	584	658	338	912	945	1,082
Liquor Law Violations	2,485	2,313	1,358	461	368	290	292
Disorderly Conduct	690	632	617	666	673	571	619
Vagrancy	23	23	17	13	16	12	16
All Other, Except Traffic	1,341	2,035	2,060	2,049	2,010	1,976	1,980
PART I SUBTOTAL	3,439	3,355	2,704	6,552	6,349	6,140	6,445
TOTAL	11,007	10,354	9,201	7,843	7,624	7,447	7,616

ADULT MALE ARRESTS (CONT.)

AGE									TOTAL ARRESTS
25-29	30-34	35-39	40-44	45-49	50-54	55-59	60-64	65-Over	
41	31	28	15	7	7	3	1	--	239
46	43	31	14	10	4	2	1	1	225
199	162	106	50	23	9	2	1	2	1,011
903	894	738	492	222	121	59	39	46	5,147
608	569	383	232	94	36	10	14	4	3,315
3,351	3,524	3,024	1,990	1,024	486	225	182	253	20,617
331	274	176	72	38	8	4	3	3	1,786
18	13	4	12	10	3	4	1	3	117
5,497	5,510	4,500	2,877	1,428	674	309	242	312	32,457
9	5	7	1	1	3	--	--	--	39
4,248	4,456	3,380	1,836	906	404	164	134	151	20,311
271	241	204	100	32	16	6	2	6	1,394
228	228	218	95	55	28	17	9	7	1,179
38	23	18	8	5	--	1	--	1	134
580	418	302	149	65	16	13	2	5	2,627
1,094	1,029	752	406	195	97	53	22	29	5,592
703	502	336	216	114	62	19	6	10	3,654
79	80	66	41	25	15	15	7	16	405
247	293	273	186	135	75	53	33	26	1,654
216	172	112	64	37	17	9	6	3	1,031
180	172	120	75	43	13	2	1	--	1,018
80	87	51	38	19	5	1	1	2	414
327	337	230	142	38	12	2	1	1	1,426
296	250	234	145	66	25	6	1	2	1,446
1,395	1,115	756	453	166	69	21	11	6	7,644
316	263	206	110	47	11	6	1	2	1,356
347	353	279	137	51	19	5	1	7	1,902
1	1	--	2	3	2	2	3	1	24
276	284	258	155	84	27	21	16	15	1,496
4,619	4,159	3,387	2,480	1,589	965	492	299	319	23,807
1,222	1,314	1,433	1,159	820	461	293	128	171	15,068
2,675	2,644	2,234	1,443	842	377	232	131	158	15,204
57	88	94	92	37	31	13	16	12	560
8,829	8,471	6,456	3,871	2,019	975	556	281	315	45,724
28,332	26,985	21,406	13,404	7,394	3,725	2,002	1,112	1,265	155,609
33,829	32,495	25,906	16,281	8,822	4,399	2,311	1,354	1,577	188,066

ADULT FEMALE ARRESTS

OFFENSE CLASSIFICATION	AGE						
	18	19	20	21	22	23	24
PART I							
Murder/Nonneg. Manslaughter	1	--	4	--	1	1	1
Forcible Rape	--	--	--	--	--	--	--
Robbery	4	4	5	5	9	8	2
Aggravated Assault	30	28	36	28	23	46	19
Burglary	23	6	10	6	19	8	12
Larceny-Theft	533	444	392	317	277	268	296
Motor Vehicle Theft	20	23	16	10	12	8	9
Arson	1	1	--	1	1	--	--
PART I SUBTOTAL	612	506	463	367	342	339	339
PART II							
Manslaughter by Negligence	--	--	--	--	1	--	--
Other Assaults - Simple	145	178	180	191	176	182	215
Forgery and Counterfeiting	23	23	32	40	37	22	29
Fraud	9	22	30	31	20	19	19
Embezzlement	6	2	1	4	2	2	3
Stolen Property	19	20	18	21	10	26	20
Vandalism	46	43	41	46	38	49	49
Weapons: Carrying, Possessing, Etc.	11	10	18	13	11	19	10
Prostitution and Comm. Vice	35	45	40	61	54	57	64
Sex Offenses	6	6	7	6	8	9	5
DRUGS, SALE OR MFG.							
Opium, Cocaine, Derivatives	6	4	3	8	9	6	4
Marijuana	7	9	8	5	11	5	8
Synthetic Narcotics	1	2	2	5	5	1	--
Other Dangerous Nonnarcotics	10	12	10	10	19	18	14
DRUGS, POSSESSION							
Opium, Cocaine, Derivatives	3	10	14	5	14	12	14
Marijuana	104	95	81	63	62	47	49
Synthetic Narcotics	9	12	18	17	19	11	13
Other Dangerous Nonnarcotics	25	24	20	17	25	21	28
All Gambling	--	1	--	--	--	1	--
Offenses Against Family/Children	23	21	27	24	21	24	17
Driving Under the Influence	53	81	98	129	125	145	164
Liquor Law Violations	542	491	398	69	45	38	38
Disorderly Conduct	173	154	167	153	158	156	188
Vagrancy	7	8	3	4	--	--	2
All Other, Except Traffic	353	408	395	418	408	388	439
PART II SUBTOTAL	1,621	1,681	1,611	1,340	1,278	1,258	1,392
TOTAL	2,233	2,187	2,074	1,707	1,620	1,597	1,731

ADULT FEMALE ARRESTS (CONT.)

AGE									TOTAL ARRESTS
25-29	30-34	35-39	40-44	45-49	50-54	55-59	60-64	65-Over	
3	5	1	4	2	1	1	--	--	25
--	--	--	--	--	--	--	--	--	--
26	20	9	6	2	1	--	--	--	101
139	196	144	93	34	17	3	4	5	345
57	57	47	26	13	2	2	--	1	289
1,440	1,595	1,238	749	352	221	107	79	153	3,461
59	52	25	16	3	1	1	--	--	255
2	4	1	6	1	--	--	--	1	19
1,726	1,929	1,465	900	407	243	114	33	160	9,995
1	1	5	--	--	--	--	--	--	3
874	918	723	406	190	87	44	18	24	4,551
148	196	86	47	16	4	2	1	--	706
140	133	88	47	27	13	3	4	4	609
12	9	6	4	2	--	--	--	--	53
91	87	57	27	5	1	1	--	--	403
257	221	162	86	43	16	11	3	5	1,116
62	75	49	26	5	4	2	1	1	317
357	312	254	101	25	--	--	--	2	1,407
37	47	33	16	6	4	1	--	1	192
44	34	37	12	6	--	1	--	--	174
32	29	26	13	7	1	1	--	--	162
33	26	32	15	4	2	--	--	--	128
123	149	79	42	9	5	2	2	1	505
73	89	59	38	8	1	--	--	--	345
245	247	163	80	31	8	1	--	2	1,278
92	119	76	39	8	3	1	--	--	437
138	136	81	47	13	--	--	--	--	575
1	--	--	2	--	--	1	--	--	6
140	164	116	71	28	12	3	1	--	692
669	819	722	527	280	150	75	30	52	4,119
159	169	185	149	65	35	20	8	7	2,418
781	786	661	409	212	92	32	30	25	4,177
10	13	10	8	3	1	1	2	2	74
2,101	2,098	1,647	889	341	163	82	38	74	10,242
6,620	6,877	5,357	3,101	1,334	602	284	138	200	34,694
8,346	8,806	6,822	4,001	1,741	845	398	221	360	44,689



**COUNTY
ARREST
DATA**

APACHE COUNTY - TOTAL ARRESTS BY AGE

OFFENSE CLASSIFICATION	UNDER	10-12	13-14	15	16	17	TOTAL	18	19	20	21
	10						UNDER 18				
PART I											
Murder/Nonneg. Manslaughter	--	--	1	--	--	--	1	--	--	--	--
Forcible Rape	--	--	--	--	--	--	--	--	--	--	--
Robbery	--	--	--	--	--	--	--	--	--	--	--
Aggravated Assault	--	3	4	4	2	1	14	2	2	--	2
Burglary	--	3	8	2	4	1	18	1	--	2	--
Larceny-Theft	2	20	15	5	9	10	61	9	6	6	2
Motor Vehicle Theft	--	--	7	2	1	1	11	--	--	--	--
Arson	--	3	2	--	--	--	5	--	--	--	--
PART I SUBTOTAL	2	29	37	13	16	13	110	12	3	8	4
PART II											
Manslaughter by Negligence	--	--	--	--	--	--	--	--	--	--	--
Other Assaults - Simple	4	4	9	13	9	3	42	8	4	2	4
Forgery and Counterfeiting	--	--	--	--	--	1	1	--	--	1	--
Fraud	--	--	--	--	--	--	--	--	--	--	--
Embezzlement	--	--	--	--	--	--	--	--	--	--	--
Stolen Property	--	--	--	--	--	--	--	--	--	--	--
Vandalism	4	1	9	1	1	1	17	--	--	--	--
Weapons: Carrying, Possessing, Etc.	--	1	--	--	--	2	3	--	--	--	--
Prostitution and Comm. Vice	--	--	--	--	--	--	--	--	--	--	--
Sex Offenses	--	--	3	--	1	--	4	--	--	--	--
DRUGS, SALE OR MFG.											
Opium, Cocaine, Derivatives	--	--	--	--	--	--	--	--	--	--	--
Marijuana	--	--	--	--	--	--	--	2	1	1	--
Synthetic Narcotics	--	--	--	--	--	--	--	--	--	--	--
Other Dangerous Nonnarcotics	--	--	--	--	--	--	--	1	--	--	1
DRUGS, POSSESSION											
Opium, Cocaine, Derivatives	--	--	--	--	--	--	--	--	--	--	--
Marijuana	--	1	5	4	3	3	16	9	10	4	3
Synthetic Narcotics	--	--	--	--	1	1	2	2	3	1	3
Other Dangerous Nonnarcotics	--	4	--	--	--	--	4	--	1	1	--
All Gambling											
Offenses Against Family/Children	--	--	--	1	--	--	1	--	1	--	1
Driving Under the Influence	--	--	--	--	--	--	--	1	3	2	--
Liquor Law Violations	--	3	16	20	30	26	95	16	10	3	--
Disorderly Conduct	1	6	11	7	8	6	39	7	6	7	8
Vagrancy	--	--	--	--	--	--	--	--	--	--	--
All Other, Except Traffic	2	5	27	14	13	9	70	8	12	7	6
Curfew/Loitering (Juvenile)	--	3	--	3	5	7	18	--	--	--	--
Runaways (Juvenile)	--	--	14	9	8	3	34	--	--	--	--
PART II SUBTOTAL	11	28	94	72	79	62	346	54	51	34	27
TOTAL	13	57	131	85	95	75	456	66	59	42	31

APACHE COUNTY - TOTAL ARRESTS BY AGE (CONT.)

22	23	24	25-29	30-34	35-39	40-44	45-49	50-54	55-59	60-64	65 AND OVER	TOTAL OVER '8	TOTAL ALL AGES
--	1	--	--	--	--	--	--	--	--	--	--	1	21
--	--	--	--	--	--	--	--	--	1	--	--	1	11
--	--	--	1	--	--	--	--	--	--	--	--	1	11
4	1	3	8	5	5	7	4	--	--	--	1	44	58
2	--	--	6	2	1	1	2	1	1	--	--	19	37
--	--	3	5	6	7	3	1	1	1	--	2	52	131
--	--	--	--	1	--	--	--	--	--	--	--	1	12
--	--	--	--	--	--	--	--	--	--	--	--	--	5
6	2	6	20	14	13	11	7	2	3	--	3	119	229
--	--	--	--	--	--	--	--	--	--	--	--	--	--
3	4	3	11	15	8	16	5	2	1	3	--	39	171
--	--	--	1	--	--	--	1	--	--	--	--	3	4
--	--	--	--	1	--	1	1	--	--	1	--	4	4
--	--	--	--	--	--	--	--	--	--	--	--	--	--
--	--	--	1	--	1	--	--	--	--	--	--	2	21
2	--	--	1	--	1	1	--	--	1	--	--	7	14
--	--	--	1	--	--	--	--	--	--	--	--	1	11
--	--	--	--	--	--	--	--	--	--	--	--	--	11
--	--	--	1	--	--	--	1	--	--	--	--	2	21
--	--	--	4	4	1	--	--	1	--	--	--	14	121
--	--	--	--	--	--	--	--	--	--	--	--	--	--
--	--	1	--	--	1	--	--	--	--	--	--	4	4
--	--	--	--	1	--	--	--	--	--	--	--	1	1
2	3	--	15	8	11	11	2	1	--	--	--	79	95
2	--	--	5	5	1	1	1	--	--	--	--	24	26
--	--	--	--	--	1	--	--	--	--	--	--	3	7
--	--	--	--	--	--	--	--	--	--	--	--	--	--
1	--	--	2	4	5	3	--	--	--	--	--	17	18
--	--	2	5	6	4	6	4	2	5	--	2	42	42
2	--	1	5	3	4	--	--	1	--	--	--	50	145
4	5	3	11	11	13	16	4	2	--	1	1	99	138
--	--	--	--	--	--	--	--	--	--	1	--	1	1
4	3	4	17	28	22	15	12	6	2	3	--	149	219
--	--	--	--	--	--	--	--	--	--	--	--	--	18
--	--	--	--	--	--	--	--	--	--	--	--	--	34
20	15	14	80	86	73	70	31	15	9	9	3	591	937
26	17	20	100	100	86	81	38	17	12	9	6	710	1,166

COCHISE COUNTY - TOTAL ARRESTS BY AGE

OFFENSE CLASSIFICATION	UNDER	10-12	13-14	15	16	17	TOTAL	18	19	20	21
	10						UNDER 18				
PART I											
Murder/Nonneg. Manslaughter	--	--	--	--	--	--	--	--	--	--	--
Forcible Rape	--	--	--	--	--	--	--	--	1	--	--
Robbery	--	--	1	1	--	1	3	1	2	3	--
Aggravated Assault	--	3	2	6	7	9	27	8	2	--	3
Burglary	--	3	10	13	12	16	54	8	5	1	2
Larceny-Theft	14	91	111	52	59	60	387	42	31	29	17
Motor Vehicle Theft	--	2	8	10	7	7	34	2	4	2	--
Arson	3	3	--	1	--	--	7	--	--	--	--
PART I SUBTOTAL	17	102	132	83	85	93	512	61	45	35	24
PART II											
Manslaughter by Negligence	--	--	--	--	--	--	--	--	--	--	--
Other Assaults - Simple	5	22	45	33	15	27	147	10	15	13	3
Forgery and Counterfeiting	--	1	--	1	--	--	2	--	--	--	--
Fraud	--	--	--	1	1	--	2	1	2	3	--
Embezzlement	--	--	--	--	--	1	1	--	--	--	--
Stolen Property	--	--	2	2	1	1	6	2	1	1	--
Vandalism	13	14	35	12	20	11	105	5	2	1	2
Weapons: Carrying, Possessing, Etc.	--	--	2	3	1	2	8	1	2	4	--
Prostitution and Comm. Vice	--	--	--	--	--	--	--	--	--	--	--
Sex Offenses	--	3	3	--	--	1	7	--	1	--	--
DRUGS, SALE OR MFG.											
Opium, Cocaine, Derivatives	--	--	--	--	--	--	--	--	--	--	--
Marijuana	--	--	3	2	9	5	19	4	3	3	--
Synthetic Narcotics	--	--	--	--	--	--	--	--	--	--	--
Other Dangerous Nonnarcotics	--	--	--	--	--	--	--	2	2	1	--
DRUGS, POSSESSION											
Opium, Cocaine, Derivatives	--	--	1	--	--	1	2	--	--	--	--
Marijuana	--	2	23	23	29	24	101	19	20	19	13
Synthetic Narcotics	--	--	--	--	--	2	2	--	--	--	--
Other Dangerous Nonnarcotics	--	--	--	--	1	4	5	3	1	2	--
All Gambling											
Offenses Against Family/Children	1	7	25	6	10	5	54	14	3	13	16
Driving Under the Influence	--	--	--	--	--	2	2	5	8	7	12
Liquor Law Violations	--	2	20	18	16	16	72	21	18	23	3
Disorderly Conduct	1	3	35	37	29	28	138	14	11	9	9
Vagrancy	1	2	2	--	3	--	3	1	2	--	--
All Other, Except Traffic	16	15	71	45	70	42	259	47	43	47	42
Curfew/Loitering (Juvenile)	--	4	42	42	33	26	147	--	--	--	--
Runaways (Juvenile)	5	25	103	85	93	54	365	--	--	--	--
PART II SUBTOTAL	42	105	412	310	331	252	1,452	149	139	146	116
TOTAL	59	207	544	393	416	345	1,964	210	184	181	140

COCHISE COUNTY - TOTAL ARRESTS BY AGE (CONT.)

22	23	24	25-29	30-34	35-39	40-44	45-49	50-54	55-59	60-64	65 AND OVER	TOTAL OVER 18	TOTAL ALL AGES
--	--	--	--	1	1	1	--	--	--	--	--	3	31
--	--	--	--	--	--	--	--	--	--	--	--	--	--
--	1	1	--	2	--	--	--	--	--	--	--	11	141
--	2	2	6	15	13	5	1	2	2	2	--	63	901
3	8	2	10	12	5	4	--	--	--	1	--	61	1151
14	8	13	62	48	46	42	8	17	12	7	13	409	7361
--	3	1	3	3	3	1	1	--	--	--	--	24	681
--	--	--	--	--	1	--	--	--	--	--	--	1	31
17	22	19	81	81	69	53	10	19	14	10	13	573	1,0851
--	--	--	--	--	--	--	--	--	--	--	--	--	--
9	9	8	30	46	36	16	18	5	3	4	2	232	3701
1	--	1	2	2	2	2	--	--	--	--	--	10	121
4	5	1	18	17	13	7	4	--	--	--	1	77	791
1	--	1	1	1	--	--	--	--	--	--	--	4	51
--	1	1	7	1	2	2	--	--	--	--	--	13	241
3	2	2	10	8	5	2	3	--	1	--	--	46	1811
--	--	--	4	5	3	1	--	1	--	--	--	21	791
--	--	--	--	--	--	--	--	--	--	--	--	--	--
--	--	--	1	1	3	1	2	1	1	--	--	11	161
--	--	--	2	--	--	--	--	--	--	--	--	2	21
2	3	3	12	3	5	3	--	--	--	--	--	45	641
--	--	--	--	--	1	1	--	1	--	--	--	3	31
1	--	--	2	2	1	--	--	--	--	--	--	12	121
--	--	--	4	1	1	--	--	--	--	--	--	7	31
12	10	11	46	29	23	18	10	1	--	--	--	231	3321
2	1	--	1	--	--	1	--	--	--	--	--	5	31
3	2	--	6	7	7	3	--	--	--	--	--	34	391
--	--	--	--	--	--	--	--	--	--	--	--	--	--
22	14	17	59	92	67	37	20	10	8	5	5	409	4631
10	11	17	66	74	65	51	31	11	12	6	11	397	3991
1	2	3	11	6	6	3	4	--	1	--	--	102	1741
10	11	7	46	61	47	33	16	7	3	1	4	289	4271
--	--	--	--	--	2	--	--	--	--	--	--	6	141
37	34	36	168	152	147	71	43	17	15	8	11	918	1,1771
--	--	--	--	--	--	--	--	--	--	--	--	--	147
--	--	--	--	--	--	--	--	--	--	--	--	--	365
118	105	108	496	508	436	252	151	54	44	24	34	2,880	4,3321
135	127	127	577	589	505	305	161	73	58	34	47	3,453	5,4171

COCONINO COUNTY - TOTAL ARRESTS BY AGE

OFFENSE CLASSIFICATION	UNDER 10	10-12	13-14	15	16	17	TOTAL UNDER 18	18	19	20	21
PART I											
Murder/Nonneg. Manslaughter	--	--	--	--	--	1	1	--	--	--	1
Forcible Rape	--	--	2	--	--	--	2	--	--	2	--
Robbery	--	--	--	--	1	4	5	2	1	1	3
Aggravated Assault	3	6	9	10	22	10	60	11	15	21	10
Burglary	1	3	58	31	24	30	147	17	8	4	5
Larceny-Theft	11	45	92	57	60	83	348	133	85	63	55
Motor Vehicle Theft	--	--	13	14	1	1	29	--	1	1	2
Arson	--	3	3	--	--	--	6	1	--	--	--
PART I SUBTOTAL	15	57	177	112	108	129	598	164	110	92	76
PART II											
Manslaughter by Negligence	--	--	--	--	--	--	--	--	--	--	--
Other Assaults - Simple	--	8	28	25	30	15	106	33	19	27	27
Forgery and Counterfeiting	--	--	1	--	--	2	3	4	6	5	2
Fraud	--	--	--	3	1	1	5	3	2	6	5
Embezzlement	--	--	--	--	--	--	--	--	--	--	--
Stolen Property	--	--	2	--	4	3	9	3	1	5	--
Vandalism	7	8	42	40	17	13	127	18	15	25	21
Weapons: Carrying, Possessing, Etc.	--	--	--	3	6	6	15	9	4	3	4
Prostitution and Comm. Vice	--	--	--	--	--	--	--	--	--	--	--
Sex Offenses	--	1	5	21	2	--	29	8	4	12	6
DRUGS, SALE OR MFG.											
Opium, Cocaine, Derivatives	--	--	--	--	--	--	--	1	--	--	--
Marijuana	--	--	2	--	--	--	2	1	6	1	--
Synthetic Narcotics	--	--	5	--	--	--	5	--	--	--	--
Other Dangerous Nonnarcotics	--	--	--	--	--	--	--	--	--	--	--
DRUGS, POSSESSION											
Opium, Cocaine, Derivatives	--	2	5	2	2	3	14	1	2	1	2
Marijuana	--	2	29	25	34	26	116	43	36	22	19
Synthetic Narcotics	--	--	10	2	--	2	14	1	--	1	1
Other Dangerous Nonnarcotics	--	--	1	1	5	2	9	6	7	3	2
All Gambling	--	--	--	--	--	--	--	--	--	--	--
Offenses Against Family/Children	--	--	2	2	5	1	10	23	17	16	9
Driving Under the Influence	--	1	--	3	3	15	23	53	58	66	20
Liquor Law Violations	--	2	41	74	75	81	274	69	93	102	37
Disorderly Conduct	3	5	50	54	57	45	215	83	32	100	116
Vagrancy	--	--	--	--	--	--	--	2	--	2	1
All Other, Except Traffic	6	21	151	148	102	107	535	119	166	159	178
Curfew/Loitering (Juvenile)	--	--	--	6	5	7	19	--	--	--	--
Runaways (Juvenile)	--	7	37	57	39	23	163	--	--	--	--
PART II SUBTOTAL	18	59	411	466	387	352	1,693	480	518	556	550
TOTAL	33	116	588	578	495	481	2,291	644	628	648	626

COCONINO COUNTY - TOTAL ARRESTS BY AGE (CONT.)

22	23	24	25-29	30-34	35-39	40-44	45-49	50-54	55-59	60-64	65 AND OVER	TOTAL OVER 18	TOTAL ALL AGES
1	--	2	1	2	1	--	--	--	--	--	--	3	9
1	--	--	2	2	3	2	--	--	--	--	--	12	14
--	2	--	4	7	--	--	--	--	--	--	--	20	25
25	16	9	43	39	42	30	7	9	--	1	--	278	338
5	6	5	15	9	9	1	--	1	--	--	--	95	232
54	52	49	150	135	112	74	49	12	3	5	11	1,047	1,395
2	1	2	2	--	4	--	1	1	--	--	--	17	46
1	--	--	5	5	2	2	3	--	--	--	--	19	25
39	77	67	222	199	173	109	60	23	3	6	11	1,486	2,084
--	--	--	--	--	--	--	--	--	--	--	--	--	--
47	31	37	184	153	132	64	30	9	4	2	3	802	908
4	--	16	3	17	--	5	--	--	1	1	--	64	67
5	3	2	7	10	3	2	3	--	--	--	--	51	56
--	--	--	--	--	--	--	--	--	--	--	--	--	--
3	1	3	6	5	2	1	--	--	--	--	--	30	39
16	12	13	76	62	44	21	9	7	--	2	1	342	469
6	3	3	10	6	9	2	1	4	--	--	--	63	78
--	--	--	--	--	--	--	--	--	--	--	--	--	--
6	4	8	14	10	22	18	9	5	3	2	2	133	162
1	1	--	2	--	--	--	--	--	--	--	--	6	6
3	1	--	1	4	2	2	1	--	--	--	--	22	24
--	--	--	--	--	--	--	--	--	--	--	--	--	5
2	1	--	1	2	2	1	--	--	--	--	--	9	9
2	--	1	8	9	3	2	3	--	--	--	--	34	48
18	20	10	67	34	20	18	8	3	1	--	--	319	435
1	--	3	2	1	7	5	--	--	--	--	--	22	36
6	7	3	17	20	10	7	--	--	--	--	--	98	97
--	--	--	--	--	--	--	--	--	--	--	--	--	--
11	18	6	43	55	55	27	14	4	2	3	--	303	313
120	81	92	355	263	225	134	89	37	25	9	10	1,727	1,760
32	22	17	58	56	44	31	25	17	4	2	2	611	885
107	83	92	344	334	313	189	91	52	11	13	9	2,019	2,234
2	1	--	5	25	15	18	4	10	--	4	--	99	89
172	150	149	662	624	395	230	127	53	33	20	15	3,252	3,787
--	--	--	--	--	--	--	--	--	--	--	--	--	19
--	--	--	--	--	--	--	--	--	--	--	--	--	163
564	439	455	1,365	1,690	1,302	777	414	201	84	58	42	9,995	11,688
653	516	522	2,087	1,889	1,475	886	474	224	92	64	53	11,481	13,772

GILA COUNTY - TOTAL ARRESTS BY AGE

OFFENSE CLASSIFICATION	UNDER 10	10-12	13-14	15	16	17	TOTAL UNDER 18	18	19	20	21
PART I											
Murder/Nonneg. Manslaughter	--	--	--	--	--	--	--	--	--	--	--
Forcible Rape	--	--	--	--	--	--	--	--	--	--	--
Robbery	--	--	--	--	--	--	--	--	1	--	--
Aggravated Assault	4	7	9	8	3	3	34	5	1	2	4
Burglary	2	6	5	9	7	6	35	3	1	2	--
Larceny-Theft	4	47	72	47	42	25	237	13	12	9	5
Motor Vehicle Theft	--	1	4	10	4	1	20	1	--	--	--
Arson	1	--	--	--	--	--	1	--	--	--	--
PART I SUBDTAL	11	61	90	74	56	35	327	22	15	13	10
PART II											
Manslaughter by Negligence	--	--	--	--	--	--	--	--	--	--	--
Other Assaults - Simple	--	8	32	15	12	10	77	5	9	7	7
Forgery and Counterfeiting	--	--	--	1	--	--	1	--	--	1	--
Fraud	--	--	1	--	--	--	1	1	--	1	--
Embezzlement	--	--	--	--	--	--	--	--	--	--	--
Stolen Property	--	--	--	--	--	--	--	--	--	--	--
Vandalism	6	12	19	20	9	12	78	4	6	--	7
Weapons: Carrying, Possessing, Etc.	--	2	5	4	3	--	14	3	1	1	--
Prostitution and Comm. Vice	--	--	--	--	--	1	1	--	--	--	--
Sex Offenses	--	1	1	1	2	2	7	1	1	--	--
DRUGS, SALE OR MFG.											
Opium, Cocaine, Derivatives	--	--	2	--	--	--	2	--	1	--	--
Marijuana	--	--	1	2	--	4	7	--	--	--	--
Synthetic Narcotics	--	--	--	--	--	--	--	--	--	--	--
Other Dangerous Nonnarcotics	--	--	--	--	--	1	1	--	--	--	--
DRUGS, POSSESSION											
Opium, Cocaine, Derivatives	--	--	1	1	--	--	2	--	1	--	--
Marijuana	--	--	5	3	10	11	34	5	6	4	7
Synthetic Narcotics	--	--	--	--	--	1	1	--	2	1	--
Other Dangerous Nonnarcotics	--	--	--	--	--	3	3	1	1	--	--
All Gambling											
Offenses Against Family/Children	--	1	1	--	--	1	3	12	3	3	5
Driving Under the Influence	--	--	--	--	--	1	1	4	5	13	12
Liquor Law Violations	--	--	20	17	27	39	103	57	40	22	2
Disorderly Conduct	1	18	48	29	30	26	152	19	26	17	19
Vagrancy	--	--	--	2	--	4	6	1	--	--	--
All Other, Except Traffic	7	19	40	43	23	29	161	36	43	36	34
Curfew/Loitering (Juvenile)	--	--	--	--	--	1	1	--	--	--	--
Runaways (Juvenile)	--	--	16	18	14	13	62	--	--	--	--
PART II SUBTOTAL	14	62	192	161	130	159	718	149	150	106	33
TOTAL	25	123	282	235	186	194	1,045	171	165	119	93

GILA COUNTY - TOTAL ARRESTS BY AGE (CONT.)

22	23	24	25-29	30-34	35-39	40-44	45-49	50-54	55-59	60-64	65 AND OVER	TOTAL OVER 18	TOTAL ALL AGES
--	1	--	1	1	--	1	--	--	--	--	--	4	4
--	--	--	2	--	--	--	--	--	--	--	--	2	2
1	--	--	1	--	1	2	--	--	--	--	1	5	8
6	4	3	18	21	12	11	9	2	--	--	2	100	134
1	1	2	10	3	4	3	1	--	--	--	--	31	66
13	3	6	29	38	27	17	12	3	4	--	2	193	430
--	1	2	7	3	3	1	3	1	1	--	--	23	43
--	--	--	--	--	--	--	--	--	--	1	--	1	2
21	10	13	68	66	47	35	25	6	5	1	5	362	689
--	--	--	--	--	--	--	--	--	--	--	--	--	--
5	5	6	31	38	40	23	9	8	5	1	4	203	280
--	1	--	3	--	4	2	1	1	--	--	--	13	14
--	--	5	5	3	3	--	--	--	--	--	--	19	20
--	--	--	--	--	--	--	--	--	--	--	--	--	--
--	--	--	1	--	--	--	--	--	--	--	--	1	1
5	2	2	11	6	5	6	3	3	1	1	--	56	134
--	1	3	7	10	8	2	--	--	1	--	--	38	42
--	--	--	--	--	--	--	--	--	--	--	--	--	--
--	2	--	7	2	--	4	--	1	--	--	2	20	27
--	--	--	--	--	--	--	--	--	--	--	--	--	--
--	--	--	2	--	--	--	1	--	--	--	--	4	5
--	--	--	1	--	1	--	--	1	--	--	--	3	10
--	--	--	--	--	--	--	--	--	--	--	--	--	--
--	--	--	1	--	--	--	1	--	--	--	--	2	3
--	1	--	--	2	1	--	--	--	--	--	--	5	7
--	1	--	5	6	3	1	2	--	1	--	--	35	69
--	--	1	6	5	2	1	--	--	--	--	--	18	19
--	--	1	2	2	2	--	--	--	--	--	--	9	12
--	--	--	--	--	--	--	--	--	--	--	--	--	--
7	9	6	35	32	30	27	10	3	--	--	2	190	193
6	10	6	39	55	59	48	39	25	13	6	13	353	354
2	1	2	5	1	3	2	--	3	2	1	1	144	247
18	17	16	84	96	69	63	43	13	7	6	10	523	675
--	--	--	--	--	--	8	1	2	1	--	--	13	19
46	46	45	198	203	157	80	36	28	17	3	7	1,015	1,176
--	--	--	--	--	--	--	--	--	--	--	--	--	1
--	--	--	--	--	--	--	--	--	--	--	--	--	62
89	96	93	443	461	387	267	146	88	49	18	39	2,664	3,382
110	106	106	511	527	434	302	171	94	54	19	44	3,026	4,071

GRAHAM COUNTY - TOTAL ARRESTS BY AGE

OFFENSE CLASSIFICATION	UNDER	10-12	13-14	15	16	17	TOTAL	18	19	20	21
	10						18				
PART I											
Murder/Nonneg. Manslaughter	--	--	--	--	--	--	--	--	--	--	--
Forcible Rape	--	--	--	--	--	--	--	--	--	--	--
Robbery	--	--	--	--	--	--	--	--	--	1	--
Aggravated Assault	1	10	8	1	5	4	29	2	2	1	2
Burglary	1	2	12	3	16	10	44	5	--	1	--
Larceny-Theft	3	12	24	23	22	25	109	15	8	5	1
Motor Vehicle Theft	--	1	2	1	4	1	9	--	--	1	1
Arson	2	--	1	--	--	--	3	--	--	--	--
PART I SUBTOTAL	7	25	47	28	47	40	194	22	10	9	5
PART II											
Manslaughter by Negligence	--	--	--	--	--	--	--	--	--	--	--
Other Assaults - Simple	1	2	3	1	3	3	18	1	4	--	2
Forgery and Counterfeiting	--	2	--	--	1	2	5	--	--	--	2
Fraud	--	--	--	--	--	--	--	--	--	--	--
Embezzlement	--	--	--	--	--	--	--	--	--	--	--
Stolen Property	--	--	--	--	--	1	1	--	--	--	--
Vandalism	2	3	10	2	12	5	39	5	2	--	1
Weapons: Carrying, Possessing, Etc.	--	--	--	--	--	--	--	--	--	--	--
Prostitution and Comm. Vice	--	--	--	--	--	--	--	--	--	--	--
Sex Offenses	--	--	2	--	--	--	2	--	1	--	2
DRUGS, SALE OR MFG.											
Opium, Cocaine, Derivatives	--	--	--	--	--	--	--	--	--	--	--
Marijuana	--	--	1	1	1	1	4	1	1	--	--
Synthetic Narcotics	--	--	--	--	--	--	--	--	--	--	--
Other Dangerous Nonnarcotics	--	--	--	--	--	--	--	--	--	--	--
DRUGS, POSSESSION											
Opium, Cocaine, Derivatives	--	--	--	--	--	--	--	--	--	1	--
Marijuana	--	3	1	3	5	4	16	3	2	3	1
Synthetic Narcotics	--	--	--	--	--	2	2	1	--	--	--
Other Dangerous Nonnarcotics	--	--	--	--	1	1	2	1	1	1	--
All Gambling											
Offenses Against Family/Children	--	--	--	--	1	--	1	1	--	1	1
Driving Under the Influence	--	--	--	--	1	1	2	2	1	--	4
Liquor Law Violations	--	2	16	11	16	39	94	40	44	28	1
Disorderly Conduct	--	4	20	14	14	18	70	12	9	9	9
Vagrancy	--	--	--	--	--	--	--	--	--	--	--
All Other, Except Traffic	1	10	27	29	18	21	106	12	6	7	15
Curfew/Loitering (Juvenile)	--	1	10	12	22	20	65	--	--	--	--
Runaways (Juvenile)	--	--	5	13	3	2	28	--	--	--	--
PART II SUBTOTAL	4	32	95	96	108	120	445	79	71	50	42
TOTAL	11	57	142	114	155	160	639	101	81	59	47

GRAHAM COUNTY - TOTAL ARRESTS BY AGE (CONT.)

22	23	24	25-29	30-34	35-39	40-44	45-49	50-54	55-59	60-64	65 AND OVER	TOTAL OVER 18	TOTAL ALL AGES
--	--	--	--	--	--	--	--	--	--	--	--	--	--
1	--	--	--	--	--	--	--	--	--	--	--	1	1
--	--	--	--	--	1	--	--	--	--	--	--	2	2
3	5	1	15	16	13	8	1	6	--	--	2	77	106
--	--	2	6	7	1	1	--	--	--	--	--	24	68
16	10	2	27	25	20	11	3	6	1	1	3	154	263
1	--	2	1	4	1	--	--	--	--	--	--	11	20
--	--	--	--	--	--	--	--	--	--	--	--	--	3
21	15	7	49	52	36	20	4	12	1	1	5	269	463
--	--	--	--	--	--	--	--	--	--	--	--	--	--
1	2	3	9	--	5	1	--	--	--	--	--	29	47
1	--	--	3	2	--	--	--	1	--	--	--	9	14
--	--	--	--	--	--	--	--	--	--	--	--	--	--
--	--	--	--	--	--	--	--	--	--	--	--	--	--
--	2	1	3	3	--	2	--	--	1	--	--	20	59
--	--	1	1	--	--	--	--	--	--	--	--	2	2
--	--	--	--	--	--	--	--	--	--	--	--	--	--
--	--	--	1	1	--	--	--	--	--	--	--	5	7
--	--	--	1	--	--	--	--	--	1	--	--	2	2
--	--	2	6	1	4	2	1	--	--	--	--	18	22
1	--	--	1	--	--	1	--	--	--	--	--	4	4
--	--	--	--	--	--	--	--	--	--	--	--	--	--
1	--	--	--	1	--	--	--	--	--	--	--	5	5
2	--	--	7	7	4	4	--	1	--	--	--	34	50
--	--	1	2	2	--	--	--	--	--	--	--	6	8
2	1	--	--	2	1	--	--	--	--	--	--	11	13
--	--	--	--	--	--	--	--	--	--	--	--	--	--
2	1	2	5	4	3	1	1	--	--	--	--	22	23
4	6	3	19	22	20	15	10	7	9	2	2	126	128
--	--	3	6	1	1	1	--	--	--	--	1	126	210
11	18	11	40	21	23	13	4	5	4	1	3	193	263
--	--	--	3	--	--	--	--	--	--	--	--	3	3
5	7	10	50	39	20	14	7	9	2	1	4	208	314
--	--	--	--	--	--	--	--	--	--	--	--	--	65
--	--	--	--	--	--	--	--	--	--	--	--	--	28
30	37	37	159	106	81	54	23	23	17	4	10	923	1,268
51	52	44	208	158	117	74	27	35	18	5	15	1,092	1,731

GREENLEE COUNTY - TOTAL ARRESTS BY AGE

OFFENSE CLASSIFICATION	UNDER 10	10-12	13-14	15	16	17	TOTAL UNDER 18	18	19	20	21
PART I											
Murder, Nonneg. Manslaughter	--	--	--	--	--	--	--	--	--	--	--
Forcible Rape	--	--	--	--	--	--	--	--	--	--	--
Robbery	--	--	--	--	--	--	--	--	--	--	--
Aggravated Assault	--	--	1	1	1	1	4	--	--	--	--
Burglary	--	--	1	1	1	--	3	--	--	--	--
Larceny-Theft	--	6	2	4	1	1	14	1	1	1	--
Motor Vehicle Theft	--	--	--	--	--	--	--	--	--	--	--
Arson	--	--	--	--	--	--	--	--	--	--	--
PART I SUBTOTAL	--	6	4	6	3	2	21	1	1	1	--
PART II											
Manslaughter by Negligence	--	--	--	--	--	--	--	--	--	--	--
Other Assaults - Simple	--	--	--	--	1	--	1	--	--	--	--
Forgery and Counterfeiting	--	--	--	--	--	--	--	--	--	--	--
Fraud	--	--	--	--	--	--	--	--	--	--	--
Embezzlement	--	--	--	--	--	--	--	--	--	--	--
Stolen Property	--	--	--	--	--	--	--	--	--	--	--
Vandalism	1	--	1	--	3	--	5	--	--	--	--
Weapons: Carrying, Possessing, Etc.	--	--	--	--	1	--	1	--	--	--	--
Prostitution and Comm. Vice	--	--	--	--	--	--	--	--	--	--	--
Sex Offenses	--	--	--	--	--	--	--	--	--	--	--
DRUGS, SALE DR MFG.											
Opium, Cocaine, Derivatives	--	--	--	--	--	--	--	--	--	--	--
Marijuana	--	--	--	--	1	--	1	--	--	--	--
Synthetic Narcotics	--	--	--	--	--	--	--	--	--	--	--
Other Dangerous Nonnarcotics	--	--	--	--	--	--	--	--	--	--	--
DRUGS, POSSESSION											
Opium, Cocaine, Derivatives	--	--	--	--	--	--	--	--	--	--	--
Marijuana	--	1	3	--	2	1	7	2	--	2	2
Synthetic Narcotics	--	--	1	--	2	--	3	--	1	--	--
Other Dangerous Nonnarcotics	--	--	--	--	--	--	--	--	--	--	--
Other Offenses											
All Gambling	--	--	--	--	--	--	--	--	--	--	--
Offenses Against Family/Children	--	--	--	--	--	--	--	--	--	--	--
Driving Under the Influence	--	--	--	--	--	--	--	2	--	--	2
Liquor Law Violations	--	--	6	3	15	15	44	10	10	3	--
Disorderly Conduct	--	2	8	5	2	3	20	1	1	--	4
Vagrancy	--	--	1	--	--	--	1	--	--	--	--
All Other, Except Traffic	--	2	5	3	3	1	14	2	1	5	7
Curfew/Loitering (Juvenile)	--	--	2	--	--	2	4	--	--	--	--
Runaways (Juvenile)	--	3	4	2	7	--	16	--	--	--	--
PART II SUBTOTAL	--	3	31	18	40	22	120	17	13	10	15
TOTAL	1	14	35	24	43	24	141	18	14	11	15

GREENLEE COUNTY - TOTAL ARRESTS BY AGE (CONT.)

22	23	24	25-29	30-34	35-39	40-44	45-49	50-54	55-59	60-64	65 AND OVER	TOTAL OVER 18	TOTAL ALL AGES
--	--	--	--	--	--	--	--	--	--	--	--	--	--
--	--	--	--	--	--	--	--	--	--	--	--	--	--
--	2	1	--	--	1	2	--	--	--	--	--	6	10
--	--	--	--	--	--	--	--	--	--	--	--	--	3
--	3	--	2	2	1	1	--	--	--	--	--	12	26
--	--	--	--	--	--	--	--	--	--	--	--	--	--
--	5	1	2	2	2	3	--	--	--	--	--	18	39
--	--	--	--	--	--	--	--	--	--	--	--	--	--
1	3	1	7	7	10	2	2	1	--	--	--	34	28
--	--	--	--	--	--	--	--	--	--	--	--	--	--
--	--	--	1	--	--	--	--	1	--	--	--	2	2
--	--	--	--	--	--	--	--	--	--	--	--	--	--
--	--	--	--	--	--	--	--	--	--	--	--	--	5
--	--	--	--	--	--	1	--	--	--	--	--	1	2
--	--	--	--	--	--	--	--	--	--	--	--	--	--
--	--	--	--	--	--	--	--	--	--	--	--	--	--
--	--	--	--	--	--	1	--	--	--	--	--	1	2
--	--	--	--	--	--	1	--	--	--	--	--	1	1
--	--	--	--	--	--	--	--	--	--	--	--	--	--
--	2	1	9	8	4	1	1	1	--	--	--	33	40
--	--	--	2	2	3	--	--	--	--	--	--	8	11
--	--	--	2	--	1	--	--	--	--	--	--	3	3
--	--	--	--	--	--	--	--	--	--	--	--	--	--
--	--	--	--	--	1	--	--	--	--	--	--	1	1
2	1	--	5	6	10	1	1	--	--	--	1	31	31
1	--	--	2	--	--	--	--	--	--	--	--	26	70
7	1	4	7	16	11	1	3	3	--	1	--	60	80
--	--	--	--	--	1	--	--	--	--	--	--	1	2
3	5	4	8	11	5	3	3	3	--	--	--	60	74
--	--	--	--	--	--	--	--	--	--	--	--	--	4
--	--	--	--	--	--	--	--	--	--	--	--	--	16
14	12	10	43	50	47	10	10	9	--	1	1	262	382
14	17	11	45	52	49	13	10	9	--	1	1	280	421

LA PAZ COUNTY - TOTAL ARRESTS BY AGE

OFFENSE CLASSIFICATION	UNDER 10	10-12	13-14	15	16	17	TOTAL UNDER 18	18	19	20	21
PART I											
Murder/Nonneg. Manslaughter	--	--	--	--	--	--	--	--	--	--	--
Forcible Rape	--	--	--	--	--	--	--	--	--	--	--
Robbery	--	--	--	--	--	--	--	--	--	--	--
Aggravated Assault	--	--	1	2	2	2	7	1	1	--	--
Burglary	--	1	1	1	2	1	6	2	--	--	--
Larceny-Theft	1	--	1	3	1	--	6	--	--	--	--
Motor Vehicle Theft	--	--	--	--	--	--	--	--	--	--	--
Arson	--	--	--	--	--	--	--	--	--	--	--
PART I SUBTOTAL	1	1	3	6	5	3	19	3	2	--	--
PART II											
Manslaughter by Negligence	--	--	--	--	--	--	--	--	--	--	--
Other Assaults - Simple	--	--	2	2	1	1	6	2	2	--	--
Forgery and Counterfeiting	--	--	--	--	--	--	--	--	--	--	--
Fraud	--	--	--	--	--	--	--	--	--	--	--
Embezzlement	--	--	--	--	--	--	--	--	--	--	--
Stolen Property	--	--	2	2	--	--	4	--	--	--	--
Vandalism	2	1	2	1	1	1	8	1	--	--	--
Weapons: Carrying, Possessing, Etc.	--	--	--	--	--	--	--	--	--	--	--
Prostitution and Comm. Vice	--	--	--	--	--	--	--	--	--	--	--
Sex Offenses	--	--	1	--	--	--	1	--	--	--	--
DRUGS, SALE OR MFG.											
Opium, Cocaine, Derivatives	--	--	--	--	--	--	--	--	--	--	--
Marijuana	--	--	--	--	--	--	--	--	--	--	--
Synthetic Narcotics	--	--	--	--	--	--	--	--	--	--	--
Other Dangerous Nonnarcotics	--	--	--	--	--	--	--	--	--	--	--
DRUGS, POSSESSION											
Opium, Cocaine, Derivatives	--	--	--	--	--	--	--	--	--	--	--
Marijuana	--	--	2	1	2	--	5	1	3	2	--
Synthetic Narcotics	--	--	--	--	--	--	--	--	--	--	1
Other Dangerous Nonnarcotics	--	--	--	--	--	--	--	--	--	--	--
All Gambling											
Offenses Against Family/Children	1	--	--	--	--	--	1	--	1	--	2
Driving Under the Influence	--	--	--	--	--	--	--	--	3	2	3
Liquor Law Violations	--	--	1	2	2	2	7	3	5	3	--
Disorderly Conduct	--	--	1	2	1	1	5	2	--	2	3
Vagrancy	--	--	--	--	--	--	--	--	--	--	--
All Other, Except Traffic	1	1	--	2	2	--	6	5	6	10	7
Curfew/Loitering (Juvenile)	--	--	--	--	--	--	--	--	--	--	--
Runaways (Juvenile)	--	--	--	--	--	1	1	--	--	--	--
PART II SUBTOTAL	4	2	11	12	9	6	44	14	20	21	18
TOTAL	5	3	14	18	14	9	63	17	22	21	19

LA PAZ COUNTY - TOTAL ARRESTS BY AGE (CONT.)

22	23	24	25-29	30-34	35-39	40-44	45-49	50-54	55-59	60-64	65 AND OVER	TOTAL OVER 18	TOTAL ALL AGES
--	--	--	--	--	--	--	--	--	--	--	--	--	--
--	--	--	--	--	--	--	--	--	--	--	--	--	--
--	--	--	--	1	--	--	--	--	--	--	--	1	1
--	--	1	4	4	2	6	2	1	1	2	1	27	34
--	--	--	3	--	1	1	--	--	--	--	--	7	13
2	4	1	6	3	7	5	2	1	--	3	2	37	43
--	--	--	--	--	--	--	--	--	--	--	--	--	--
--	--	--	--	--	--	--	--	--	--	--	--	--	--
2	4	2	13	8	10	12	4	2	1	5	3	72	91
--	--	--	--	--	--	--	--	--	--	--	--	--	--
1	2	--	9	12	9	5	4	--	--	1	4	54	60
--	--	--	--	--	1	--	--	--	--	--	--	1	1
--	--	--	--	--	2	--	--	--	--	--	--	2	2
--	--	--	--	--	--	--	--	--	--	--	--	--	--
--	1	--	1	1	1	2	2	1	--	--	--	9	13
--	2	--	1	5	1	--	--	2	--	--	--	14	22
--	--	--	1	--	--	2	--	--	--	--	--	3	3
--	--	--	--	--	--	--	--	--	--	--	--	--	--
1	--	--	--	2	2	--	--	--	--	1	--	6	7
--	--	1	--	--	--	--	--	--	--	--	--	1	1
--	--	--	--	--	--	--	--	--	--	--	--	--	--
--	--	--	--	--	--	--	--	--	--	--	--	--	--
1	--	--	2	1	2	2	--	--	--	--	--	14	19
--	--	--	--	2	--	--	--	--	--	--	--	3	3
--	--	--	--	--	--	--	--	--	--	--	--	--	--
1	--	1	14	21	19	6	3	5	3	3	1	90	31
--	4	1	7	15	15	10	9	9	5	1	3	86	36
1	2	--	1	4	2	--	3	--	--	--	--	24	31
--	2	2	11	12	13	7	9	1	1	2	1	68	73
--	--	--	--	--	--	--	--	--	--	--	--	--	--
11	13	11	64	65	43	33	25	12	6	8	4	323	329
--	--	--	--	--	--	--	--	--	--	--	--	--	--
--	--	--	--	--	--	--	--	--	--	--	--	--	--
16	26	16	111	140	110	67	55	30	16	15	13	688	732
18	30	18	124	148	120	79	59	32	17	20	16	760	823

MARICOPA COUNTY - TOTAL ARRESTS BY AGE

OFFENSE CLASSIFICATION	UNDER 10	10-12	13-14	15	16	17	TOTAL UNDER 18	18	19	20	21
PART I											
Murder/Nonneg. Manslaughter	--	--	3	6	12	6	27	9	15	6	3
Forcible Rape	--	3	8	4	5	3	28	7	6	3	2
Robbery	3	20	68	63	111	117	382	91	71	36	35
Aggravated Assault	12	116	231	166	185	212	922	177	155	155	139
Burglary	25	144	359	247	241	253	1,269	179	168	105	77
Larceny-Theft	118	851	2,155	1,273	1,170	1,111	6,678	1,145	974	749	698
Motor Vehicle Theft	--	52	271	245	236	205	1,009	137	107	88	61
Arson	7	31	33	16	9	7	103	3	2	--	2
PART I SUBTOTAL	165	1,217	3,128	2,020	1,969	1,919	10,418	1,748	1,498	1,142	1,022
PART II											
Manslaughter by Negligence	--	--	1	--	--	1	2	2	--	--	5
Other Assaults - Simple	23	241	720	444	467	459	2,354	338	467	511	564
Forgery and Counterfeiting	--	--	8	14	23	41	86	51	79	73	95
Fraud	--	--	12	17	25	28	82	26	47	51	35
Embezzlement	--	3	8	2	7	12	32	9	9	6	6
Stolen Property	1	35	198	204	200	208	846	231	171	134	127
Vandalism	64	241	584	397	394	310	1,990	261	179	167	149
Weapons: Carrying, Possessing, Etc.	3	13	110	104	158	200	588	240	205	186	192
Prostitution and Comm. Vice	--	--	1	7	3	6	17	39	47	38	65
Sex Offenses	2	22	68	36	18	19	165	24	26	41	32
DRUGS, SALE OR MFG.											
Opium, Cocaine, Derivatives	2	3	15	17	12	29	78	36	32	36	47
Marijuana	--	7	39	28	21	23	118	30	36	27	25
Synthetic Narcotics	--	--	3	5	3	9	20	4	5	7	3
Other Dangerous Nonnarcotics	--	2	25	28	33	27	115	34	40	35	58
DRUGS, POSSESSION											
Opium, Cocaine, Derivatives	--	2	9	9	22	27	69	47	48	61	55
Marijuana	4	49	326	360	398	410	1,547	429	433	363	311
Synthetic Narcotics	--	1	15	14	20	26	76	38	38	45	52
Other Dangerous Nonnarcotics	--	6	55	36	44	37	178	39	32	27	26
All Gambling	--	--	--	--	--	--	--	--	--	1	2
Offenses Against Family/Children	1	--	8	6	5	4	24	13	14	7	14
Driving Under the Influence	--	--	2	14	39	114	169	269	444	504	660
Liquor Law Violations	--	11	148	332	668	1,102	2,261	1,638	1,529	1,281	330
Disorderly Conduct	3	62	352	220	237	249	1,123	329	305	305	337
Vagrancy	--	--	3	3	8	15	29	20	25	11	9
All Other, Except Traffic	30	172	652	582	587	603	2,626	1,175	1,200	1,247	1,275
Curfew/Loitering (Juvenile)	33	244	1,619	1,651	1,629	1,552	6,728	--	--	--	--
Runaways (Juvenile)	19	170	970	678	629	366	2,832	--	--	--	--
PART II SUBTOTAL	185	1,284	5,951	5,208	5,650	5,877	24,155	5,322	5,411	5,164	4,479
TOTAL	350	2,501	9,079	7,228	7,619	7,796	34,573	7,070	6,909	6,306	5,501

MARICOPA COUNTY - TOTAL ARRESTS BY AGE (CONT.)

22	23	24	25-29	30-34	35-39	40-44	45-49	50-54	55-59	60-64	65 AND OVER	TOTAL OVER 18	TOTAL ALL AGES
3	8	6	16	13	11	11	4	3	2	1	--	117	144
4	9	10	29	23	17	7	6	2	1	--	1	127	155
29	37	21	139	124	70	36	17	4	2	1	--	713	1,095
149	145	127	620	677	500	321	142	68	28	23	26	3,451	4,373
86	101	91	417	427	290	173	74	26	6	9	1	2,230	3,499
673	681	616	3,170	3,409	2,868	1,758	848	410	166	134	195	18,494	25,172
75	65	61	247	210	129	60	27	1	2	1	1	1,272	2,261
2	--	3	5	8	7	4	2	--	2	--	--	40	143
1,021	1,046	935	4,643	4,891	3,892	2,370	1,120	514	209	169	224	26,444	36,362
1	1	1	6	4	3	1	1	3	--	--	--	33	35
565	626	689	3,121	3,241	2,436	1,238	591	256	104	74	83	14,304	17,258
99	69	90	338	357	239	124	37	13	4	1	5	1,674	1,760
37	38	34	223	237	194	96	42	28	11	7	5	1,111	1,193
12	6	8	48	29	18	10	4	--	1	--	1	167	199
140	139	121	601	449	320	153	59	12	11	1	2	2,671	3,617
152	164	173	820	695	515	249	112	60	28	15	12	3,750	5,740
153	146	137	607	437	270	179	90	42	14	6	7	2,911	3,499
59	59	73	369	322	246	107	39	7	10	3	3	1,485	1,503
33	36	31	174	231	178	104	77	38	29	23	17	1,094	1,259
48	50	26	160	146	95	45	24	12	6	4	1	768	846
33	20	27	88	32	50	21	22	5	3	--	--	470	588
9	4	8	52	38	27	20	6	--	--	--	--	188	205
42	62	62	371	413	262	154	30	12	1	2	1	1,579	1,694
67	52	57	295	286	251	158	66	23	6	1	1	1,474	1,543
264	237	272	998	822	530	286	94	43	10	5	--	5,097	6,644
43	32	35	256	202	142	64	24	7	2	1	--	981	1,057
38	36	41	172	170	107	59	19	4	--	--	--	770	848
--	1	--	--	--	--	2	2	1	3	2	--	14	14
6	9	4	55	53	36	24	15	4	2	--	--	256	280
553	730	845	3,582	3,308	2,579	1,866	1,126	682	309	182	200	17,939	18,108
234	181	214	865	792	809	616	373	199	118	65	70	9,314	11,575
345	285	346	1,468	1,371	1,016	600	317	146	73	38	54	7,335	8,458
7	8	6	32	32	42	35	5	5	--	--	4	241	270
1,238	1,211	1,251	5,950	5,793	4,439	2,568	1,242	563	322	174	132	29,780	32,406
--	--	--	--	--	--	--	--	--	--	--	--	--	6,728
--	--	--	--	--	--	--	--	--	--	--	--	--	2,832
4,278	4,202	4,551	20,651	19,510	14,809	8,779	4,417	2,165	1,067	604	598	106,007	130,162
5,299	5,248	5,486	25,294	24,401	18,701	11,149	5,537	2,679	1,276	773	822	132,451	167,024

MOHAVE COUNTY - TOTAL ARRESTS BY AGE

OFFENSE CLASSIFICATION	UNDER	10-12	13-14	15	16	17	TOTAL	18	19	20	21
	10						UNDER 18				
PART I											
Murder/Nonneg. Manslaughter	--	--	--	--	1	--	1	2	--	--	--
Forcible Rape	--	1	1	--	--	--	2	--	--	--	--
Robbery	--	--	1	--	1	3	5	--	4	1	3
Aggravated Assault	4	10	21	13	8	15	71	10	8	9	10
Burglary	16	24	45	22	14	21	142	9	15	6	9
Larceny-Theft	25	73	154	68	74	72	466	105	66	66	51
Motor Vehicle Theft	--	1	9	11	6	3	30	4	3	1	3
Arson	9	12	5	3	2	4	35	--	2	--	--
PART I SUBTOTAL	54	121	236	117	106	118	752	130	98	83	76
PART II											
Manslaughter by Negligence	--	--	--	--	--	--	--	--	--	--	--
Other Assaults - Simple	2	32	47	23	27	37	168	20	18	24	14
Forgery and Counterfeiting	--	--	--	--	2	1	3	4	3	3	3
Fraud	--	--	--	2	1	3	6	1	1	2	6
Embezzlement	--	--	--	--	--	--	--	--	--	--	--
Stolen Property	--	2	5	3	2	2	14	3	4	--	3
Vandalism	10	56	58	19	22	35	200	22	12	11	6
Weapons: Carrying, Possessing, Etc.	--	5	6	1	5	7	24	5	1	5	2
Prostitution and Comm. Vice	--	--	--	--	--	--	--	--	--	--	--
Sex Offenses	--	3	7	2	1	3	16	4	6	1	3
DRUGS, SALE OR MFG.											
Opium, Cocaine, Derivatives	--	--	1	2	2	6	11	3	9	3	4
Marijuana	--	--	--	1	1	--	2	3	2	3	2
Synthetic Narcotics	--	--	5	1	2	1	9	1	2	--	--
Other Dangerous Nonnarcotics	--	--	2	--	--	--	2	1	2	3	1
DRUGS, POSSESSION											
Opium, Cocaine, Derivatives	--	--	--	--	--	--	--	--	--	--	--
Marijuana	--	4	21	11	11	14	61	3	11	3	10
Synthetic Narcotics	--	--	6	5	5	3	19	2	1	4	1
Other Dangerous Nonnarcotics	--	--	3	2	--	4	15	3	2	2	--
All Gambling											
Offenses Against Family/Children	--	1	3	4	2	3	13	3	3	20	9
Driving Under the Influence	--	--	--	--	3	3	7	3	19	12	16
Liquor Law Violations	--	1	30	44	82	173	330	213	234	181	14
Disorderly Conduct	2	45	96	44	45	48	280	40	23	35	36
Vagrancy	--	--	2	1	1	2	6	2	1	1	1
All Other, Except Traffic	5	41	178	35	93	86	488	79	79	78	79
Curfew/Loitering (Juvenile)	--	11	37	35	17	10	110	--	--	--	--
Runaways (Juvenile)	--	11	57	44	63	46	221	--	--	--	--
PART II SUBTOTAL	20	212	570	329	387	487	2,005	435	438	396	210
TOTAL	74	333	806	446	493	605	2,757	565	536	479	286

MOHAVE COUNTY - TOTAL ARRESTS BY AGE (CONT.)

22	23	24	25-29	30-34	35-39	40-44	45-49	50-54	55-59	60-64	65 AND OVER	TOTAL OVER 18	TOTAL ALL AGES
--	1	--	2	1	4	2	2	1	--	--	--	15	161
1	--	--	--	2	--	1	--	--	--	--	--	4	61
2	--	2	4	5	5	3	2	--	--	--	--	31	361
5	6	5	38	59	42	28	15	7	8	4	--	254	3251
--	9	9	28	28	19	7	7	2	--	1	1	150	1921
35	40	43	179	189	155	104	51	20	26	13	15	1,158	1,6241
1	--	1	6	5	2	2	1	--	--	--	--	29	591
--	--	--	3	2	1	6	2	2	--	--	1	20	551
44	56	60	260	291	228	153	80	32	35	18	17	1,661	2,4131
--	--	--	--	--	1	--	--	--	--	--	--	--	--
29	21	26	136	152	132	94	35	21	10	6	4	742	9101
1	--	1	15	14	11	1	4	1	1	--	--	62	651
3	1	5	15	19	10	6	5	2	1	--	--	77	831
--	--	--	--	--	--	1	--	--	--	--	--	--	--
--	1	3	11	12	11	1	2	--	--	--	--	51	651
6	15	8	37	55	35	13	11	2	5	2	3	243	4431
2	2	2	9	18	17	12	4	--	--	--	1	80	1041
--	--	--	--	--	1	--	--	--	--	--	--	--	--
1	--	1	13	6	11	16	8	5	2	--	--	77	931
3	6	3	9	11	6	5	4	1	--	--	1	73	641
--	--	--	7	2	6	1	2	1	--	1	--	30	321
1	--	1	6	6	3	5	3	--	--	--	--	28	371
1	6	5	26	19	14	12	5	3	2	--	--	100	1021
--	--	--	2	1	2	--	--	--	--	--	--	5	51
14	5	4	34	38	31	15	6	1	--	--	--	185	2461
2	--	1	17	11	10	7	2	2	--	--	--	60	791
2	6	6	16	16	19	5	4	1	--	--	--	62	971
--	--	--	--	--	--	--	--	--	--	--	--	--	--
9	11	16	93	92	90	53	27	9	3	3	3	454	4671
18	23	20	106	118	104	94	68	46	24	17	10	703	7101
10	9	7	44	46	39	32	20	9	6	7	4	875	1,2051
33	32	39	176	192	159	85	60	39	17	20	15	1,001	1,2811
--	--	--	3	3	7	--	1	1	--	--	--	20	261
75	84	85	439	485	347	224	129	63	32	15	25	2,318	2,8061
--	--	--	--	--	--	--	--	--	--	--	--	--	110
--	--	--	--	--	--	--	--	--	--	--	--	--	221
210	222	233	1,214	1,316	1,066	682	400	207	103	71	66	7,269	9,2741
254	278	293	1,474	1,607	1,294	835	480	239	138	89	83	8,930	11,6871

NAVAJO COUNTY - TOTAL ARRESTS BY AGE

OFFENSE CLASSIFICATION	UNDER	10-12	13-14	15	16	17	TOTAL	18	19	20	21
	10						UNDER 18				
PART I											
Murder/Nonneg. Manslaughter	--	--	--	--	--	--	--	--	--	--	--
Forcible Rape	--	--	--	--	--	--	--	--	--	--	--
Robbery	--	--	2	--	--	1	3	1	1	--	2
Aggravated Assault	2	3	11	4	9	18	47	8	7	4	7
Burglary	2	8	11	7	11	11	50	4	3	2	3
Larceny-Theft	5	35	62	49	53	41	245	22	28	23	14
Motor Vehicle Theft	--	--	3	9	5	5	22	2	1	1	2
Arson	--	--	--	--	1	1	2	--	2	--	--
PART I SUBTOTAL	9	46	89	69	79	77	369	37	42	30	23
PART II											
Manslaughter by Negligence	--	--	--	--	--	--	--	--	1	--	--
Other Assaults - Simple	--	13	25	15	18	27	98	17	17	13	12
Forgery and Counterfeiting	--	--	--	--	--	--	--	1	--	--	--
Fraud	--	--	--	--	--	--	--	--	--	1	--
Embezzlement	--	--	--	--	--	--	--	--	--	--	--
Stolen Property	--	--	--	--	1	1	2	2	1	--	--
Vandalism	3	7	14	3	12	10	54	5	6	3	4
Weapons: Carrying, Possessing, Etc.	--	--	3	3	7	4	22	--	3	1	--
Prostitution and Comm. Vice	--	--	--	--	--	--	--	--	--	--	--
Sex Offenses	1	1	--	--	--	1	3	1	--	2	--
DRUGS, SALE OR MFG.											
Opium, Cocaine, Derivatives	--	--	--	--	--	--	--	--	--	--	--
Marijuana	--	--	6	2	6	4	18	4	2	3	--
Synthetic Narcotics	--	--	--	--	2	--	2	--	1	--	--
Other Dangerous Nonnarcotics	--	--	--	--	--	--	--	--	--	--	--
DRUGS, POSSESSION											
Opium, Cocaine, Derivatives	--	--	--	--	--	--	--	--	--	3	1
Marijuana	--	2	4	7	9	14	36	25	10	10	4
Synthetic Narcotics	--	--	3	2	1	1	7	--	1	--	2
Other Dangerous Nonnarcotics	--	--	2	4	2	2	10	3	--	3	2
DRUGS, OTHER											
All Gambling	--	--	--	--	--	--	--	--	--	--	--
Offenses Against Family/Children	--	--	--	--	--	--	--	2	--	1	4
Driving Under the Influence	--	--	--	2	2	1	5	11	5	13	14
Liquor Law Violations	--	1	35	41	54	49	180	73	47	27	9
Disorderly Conduct	1	15	25	21	41	34	137	36	23	27	20
Vagrancy	--	--	2	1	2	1	6	3	3	6	5
All Other, Except Traffic	2	12	31	25	31	41	142	28	48	44	34
Curfew/Loitering (Juvenile)	--	--	3	3	5	5	16	--	--	--	--
Runaways (Juvenile)	--	7	19	28	33	31	118	--	--	--	--
PART II SUBTOTAL	7	58	77	162	226	226	856	211	168	158	112
TOTAL	16	104	266	231	305	303	1,225	248	210	188	140

NAVAJO COUNTY - TOTAL ARRESTS BY AGE (CONT.)

22	23	24	25-29	30-34	35-39	40-44	45-49	50-54	55-59	60-64	65 AND OVER	TOTAL OVER 18	TOTAL ALL AGES
--	--	--	--	--	1	--	--	--	--	--	--	1	1
--	--	--	--	1	2	--	--	--	--	--	--	3	3
--	--	--	1	1	--	--	--	--	--	--	--	6	9
5	6	6	22	27	27	18	9	3	2	1	3	155	202
5	2	4	13	11	6	3	--	--	--	--	--	56	106
10	15	11	73	58	53	34	24	11	6	6	5	393	638
1	1	--	4	1	1	3	--	--	1	--	--	18	40
--	--	--	--	--	--	1	--	--	--	--	--	3	5
21	24	21	113	99	90	59	33	14	9	7	3	635	1004
--	--	--	--	--	--	--	--	--	--	--	--	--	--
22	11	17	97	107	77	47	22	12	1	4	3	469	667
--	--	--	3	1	2	--	1	--	--	--	--	3	8
--	3	1	2	1	4	1	1	--	--	--	--	14	14
--	--	--	--	1	--	1	--	--	--	--	--	3	3
--	--	--	2	1	--	--	2	--	--	1	--	3	11
4	5	1	16	12	5	14	1	2	1	1	--	90	134
--	2	1	1	3	5	2	1	3	--	1	--	23	45
--	--	--	--	--	--	--	--	--	--	--	--	--	--
1	--	1	3	3	7	4	1	2	--	2	2	29	32
--	--	--	1	--	3	1	--	--	--	--	--	5	5
2	--	4	3	14	4	5	2	--	--	--	--	43	63
--	--	1	3	8	3	2	1	--	--	--	--	20	22
--	1	1	6	5	1	2	3	--	1	--	--	20	20
--	1	1	3	1	4	--	--	--	--	--	--	14	14
5	8	4	12	17	3	9	3	--	--	--	--	115	151
1	1	--	4	2	1	3	1	--	--	--	--	16	23
2	--	--	2	1	1	2	--	--	--	--	--	19	29
--	--	--	--	--	--	--	--	--	--	--	--	--	--
2	1	--	8	7	14	4	4	--	--	--	--	47	47
11	10	9	72	76	60	70	30	20	14	4	5	424	429
9	6	2	17	18	20	12	11	10	2	3	--	266	446
25	20	24	92	90	99	52	25	6	4	5	3	551	688
5	2	6	21	29	31	27	17	13	10	11	9	198	204
43	43	49	183	206	133	109	38	31	17	6	7	1,019	1,161
--	--	--	--	--	--	--	--	--	--	--	--	--	16
--	--	--	--	--	--	--	--	--	--	--	--	--	118
132	114	122	541	603	485	367	164	99	50	38	29	3,393	4,249
153	138	143	654	702	575	426	197	113	59	45	37	4,028	5,253

PIMA COUNTY - TOTAL ARRESTS BY AGE

OFFENSE CLASSIFICATION	UNDER	10-12	13-14	15	16	17	TOTAL	18	19	20	21
	10						UNDER 18				
PART I											
Murder/Nonneg. Manslaughter	--	1	1	--	2	8	12	5	7	9	21
Forcible Rape	--	1	--	1	1	1	4	6	4	4	31
Robbery	--	4	31	25	31	41	132	27	25	21	161
Aggravated Assault	11	34	91	65	70	74	345	85	45	36	441
Burglary	19	57	122	96	112	96	502	92	47	32	361
Larceny-Theft	87	445	799	460	409	395	2,595	392	285	239	1,461
Motor Vehicle Theft	--	23	145	134	131	95	528	90	49	38	281
Arson	33	54	35	5	5	5	137	7	7	1	111
PART I SUBTOTAL	150	619	1,224	786	761	715	4,255	704	469	380	2761
PART II											
Manslaughter by Negligence	--	--	1	--	--	--	1	1	1	--	--
Other Assaults - Simple	68	267	442	257	233	214	1,481	181	205	178	234
Forgery and Counterfeiting	--	1	1	6	9	5	22	8	7	16	7
Fraud	--	--	6	12	3	6	32	9	12	12	10
Embezzlement	--	--	--	--	--	--	--	--	--	--	--
Stolen Property	--	--	3	3	7	5	18	10	18	6	3
Vandalism	72	181	244	172	134	111	914	104	69	70	221
Weapons: Carrying, Possessing, Etc.	3	12	51	36	45	71	218	78	63	50	41
Prostitution and Comm. Vice	--	--	2	--	2	1	5	3	3	6	3
Sex Offenses	2	17	24	11	16	9	79	8	7	11	5
DRUGS, SALE OR MFG.											
Opium: Cocaine, Derivatives	--	--	4	4	6	11	25	13	17	16	11
Marijuana	--	4	13	7	11	5	40	19	13	14	16
Synthetic Narcotics	--	--	2	4	6	1	13	3	7	3	4
Other Dangerous Nonnarcotics	--	1	10	7	4	6	28	5	3	1	3
DRUGS, POSSESSION											
Opium, Cocaine, Derivatives	--	--	--	--	2	2	4	4	3	7	21
Marijuana	2	54	265	188	218	221	948	306	218	143	1291
Synthetic Narcotics	--	1	7	12	19	22	61	18	19	24	181
Other Dangerous Nonnarcotics	1	30	127	150	147	110	565	130	98	75	511
All Gambling	--	1	1	1	2	2	7	2	2	--	--
Offenses Against Family/Children	--	1	4	2	2	3	12	2	5	11	71
Driving Under the Influence	--	--	1	3	13	29	46	57	82	92	164
Liquor Law Violations	2	10	99	154	251	378	894	714	613	430	1011
Disorderly Conduct	25	200	534	395	313	282	1,749	239	215	200	1,891
Vagrancy	--	--	1	2	1	1	5	1	--	--	--
All Other, Except Traffic	30	113	336	248	280	251	1,258	449	508	497	501
Curfew/Lornering (Juvenile)	10	79	411	306	310	254	1,370	--	--	--	--
Runaways (Juvenile)	25	350	1,411	1,008	766	428	3,988	--	--	--	--
PART II SUBTOTAL	240	1,322	4,000	2,988	2,805	2,428	13,783	2,369	2,188	1,867	1,585
TOTAL	390	1,941	5,224	3,774	3,566	3,143	18,038	3,073	2,657	2,247	1,861

PIMA COUNTY - TOTAL ARRESTS BY AGE (CONT.)

22	23	24	25-29	30-34	35-39	40-44	45-49	50-54	55-59	60-64	65 AND OVER	TOTAL OVER 18	TOTAL ALL AGES
4	1	7	13	11	8	2	--	1	1	--	--	71	331
--	2	1	13	13	6	4	4	2	--	1	--	63	57
12	10	9	67	38	31	14	6	2	--	--	1	279	411
30	38	39	153	131	134	77	40	20	11	3	13	904	1,249
33	23	20	89	80	62	41	18	3	3	2	1	582	1,084
138	151	163	731	801	653	508	283	139	80	64	117	4,890	7,485
27	24	22	98	80	45	18	6	4	1	1	2	533	1,061
--	4	2	5	2	2	3	2	--	--	--	3	39	176
244	253	263	1,169	1,156	941	667	359	171	96	76	137	7,361	11,616
1	--	--	2	2	3	--	--	--	--	--	--	10	11
210	239	246	1,099	1,208	918	539	272	123	56	40	54	5,302	7,233
6	10	7	31	24	24	9	3	3	--	1	1	157	179
7	8	8	46	46	42	21	19	5	4	4	5	258	290
--	--	1	--	1	5	--	3	--	--	--	--	10	10
4	5	12	23	20	13	11	5	2	3	--	2	142	160
72	71	70	295	327	244	145	79	26	20	3	14	1,691	2,605
40	33	28	86	50	45	26	17	7	3	--	3	570	788
7	8	7	66	69	73	35	11	7	5	4	15	322	327
3	10	9	60	70	68	43	30	23	13	5	3	368	447
17	11	11	66	46	33	24	8	2	1	2	--	278	303
13	13	17	39	46	38	30	10	4	--	--	--	272	312
9	8	3	33	34	27	14	7	4	1	1	2	175	188
2	3	3	15	19	7	7	2	1	--	1	1	73	101
4	2	7	27	17	15	7	2	1	--	--	--	98	102
94	89	100	325	283	215	127	54	21	8	5	5	2,121	3,069
24	23	23	100	128	102	61	24	5	5	--	2	576	637
50	49	61	246	261	194	104	40	12	5	1	7	1,384	1,949
1	1	1	2	1	--	2	1	1	--	1	1	16	23
8	7	6	64	55	27	23	8	--	2	--	--	225	237
157	160	190	747	699	640	468	288	175	90	62	61	4,132	4,178
96	85	60	317	483	634	557	421	220	165	51	94	5,041	5,935
195	191	192	854	924	901	610	370	141	119	58	60	5,458	7,207
2	1	6	3	10	5	11	12	1	3	2	1	58	63
489	470	471	1,859	1,746	1,406	916	432	214	138	53	147	10,296	11,554
--	--	--	--	--	--	--	--	--	--	--	--	--	1,370
--	--	--	--	--	--	--	--	--	--	--	--	--	3,988
1,511	1,497	1,544	6,405	6,569	5,679	3,790	2,118	998	641	294	478	39,533	53,316
1,755	1,750	1,807	7,574	7,725	6,620	4,457	2,477	1,169	737	370	615	46,894	64,932

PINAL COUNTY - TOTAL ARRESTS BY AGE

OFFENSE CLASSIFICATION	UNDER 10	10-12	13-14	15	16	17	TOTAL UNDER 18	18	19	20	21
PART I											
Murder/Nonneg. Manslaughter	--	1	--	--	--	--	1	--	--	--	--
Forcible Rape	--	--	1	--	1	--	2	1	--	--	--
Robbery	--	1	1	1	2	3	8	1	--	--	--
Aggravated Assault	1	4	5	14	17	30	71	18	12	8	9
Burglary	1	8	32	21	40	29	131	18	13	6	5
Larceny-Theft	18	61	119	72	63	69	402	61	52	25	19
Motor Vehicle Theft	--	4	12	12	13	8	49	6	2	2	2
Arson	--	--	5	6	4	2	17	--	1	1	--
PART I SUBTOTAL	20	79	175	126	140	141	681	105	80	42	36
PART II											
Manslaughter by Negligence	--	--	--	--	--	--	--	--	--	--	--
Other Assaults - Simple	7	34	78	55	59	59	292	52	49	43	42
Forgery and Counterfeiting	--	--	1	--	1	3	5	--	--	--	--
Fraud	--	--	--	--	1	--	1	--	1	--	2
Embezzlement	--	--	--	--	--	--	--	--	--	--	--
Stolen Property	--	4	9	7	10	7	37	3	3	1	--
Vandalism	6	57	58	70	42	53	286	15	17	13	11
Weapons: Carrying, Possessing, Etc.	--	1	4	9	3	10	27	7	6	13	5
Prostitution and Comm. Vice	--	--	--	--	--	--	--	--	--	--	--
Sex Offenses	--	1	1	3	1	3	9	--	1	1	--
DRUGS, SALE OR MFG.											
Opium, Cocaine, Derivatives	--	--	--	--	--	--	--	1	--	1	--
Marijuana	--	4	13	4	--	3	24	4	3	--	--
Synthetic Narcotics	--	--	--	--	--	--	--	--	--	2	--
Other Dangerous Nonnarcotics	--	--	--	--	1	--	1	--	2	--	--
DRUGS, POSSESSION											
Opium, Cocaine, Derivatives	2	2	10	2	5	4	25	3	12	5	4
Marijuana	--	3	28	20	17	33	101	17	3	10	3
Synthetic Narcotics	--	--	--	--	1	--	1	--	--	1	--
Other Dangerous Nonnarcotics	--	--	1	1	1	1	4	1	1	2	--
All Gambling	--	--	--	--	--	--	--	--	--	--	--
Offenses Against Family/Children	--	--	--	--	--	--	--	5	2	1	--
Driving Under the Influence	--	--	--	--	1	3	4	9	5	14	12
Liquor Law Violations	--	4	30	45	48	48	175	73	57	58	13
Disorderly Conduct	5	20	63	39	68	43	238	46	49	35	27
Vagrancy	--	1	4	1	1	2	9	--	--	--	--
All Other, Except Traffic	7	20	69	56	65	50	267	97	129	113	111
Curfew/Loitering (Juvenile)	--	8	25	19	17	8	77	--	--	--	--
Runaways (Juvenile)	--	13	30	45	33	25	196	--	--	--	--
PART II SUBTOTAL	27	172	474	376	375	355	1,779	333	340	313	235
TOTAL	47	251	649	502	515	496	2,460	438	420	355	271

PINAL COUNTY - TOTAL ARRESTS BY AGE (CONT.)

22	23	24	25-29	30-34	35-39	40-44	45-49	50-54	55-59	60-64	65 AND OVER	TOTAL OVER 18	TOTAL ALL AGES
--	--	--	1	3	--	1	--	1	--	--	--	6	71
--	1	--	--	2	3	--	--	--	--	--	--	3	101
--	1	1	4	2	3	--	--	--	--	--	--	12	201
4	6	3	34	24	37	22	11	6	4	1	2	201	272
5	1	6	25	8	9	7	2	1	1	1	--	108	239
34	32	19	133	155	113	68	25	31	5	3	14	794	1,196
1	1	2	8	3	7	1	--	1	--	1	--	37	361
--	--	--	1	--	2	--	--	--	1	--	--	6	231
44	42	31	206	197	174	99	38	40	11	11	16	1,172	1,353
--	--	--	--	--	--	--	--	--	--	--	--	--	--
29	32	35	224	197	170	98	56	28	17	11	3	1,091	1,393
--	--	2	1	3	2	1	--	--	--	--	--	10	151
--	--	1	2	2	4	2	1	1	--	--	--	16	171
--	--	--	--	--	--	--	--	--	--	--	--	--	--
2	3	--	8	8	8	5	--	2	--	--	--	44	311
12	10	4	32	42	22	16	4	3	2	--	4	207	493
3	2	4	11	19	12	6	2	2	2	--	--	94	121
--	--	--	--	--	--	--	--	--	--	--	--	--	--
1	3	1	4	7	5	3	6	2	--	--	--	40	491
1	1	1	4	--	4	1	2	1	1	--	1	19	191
--	2	2	5	6	3	2	1	--	--	--	--	28	521
2	2	--	2	9	2	--	--	--	--	--	--	19	191
--	--	--	--	2	--	--	--	1	--	--	--	6	71
6	2	5	15	11	7	10	1	2	--	--	1	34	109
9	10	8	28	26	11	9	3	1	1	1	2	142	243
1	2	2	3	10	3	4	3	--	--	--	--	29	301
1	1	1	9	4	4	2	--	2	--	--	--	28	321
--	--	--	--	--	--	--	--	--	--	--	--	--	--
5	--	1	5	8	9	2	1	3	--	--	--	43	431
21	9	13	62	31	75	48	37	30	17	9	14	456	460
12	6	15	31	49	33	36	17	24	12	4	3	443	618
35	31	37	147	144	91	59	45	21	11	5	8	791	1,029
--	--	--	--	--	--	--	--	--	--	--	--	--	9
128	91	116	565	577	454	226	96	54	21	8	11	2,797	3,064
--	--	--	--	--	--	--	--	--	--	--	--	--	77
--	--	--	--	--	--	--	--	--	--	--	--	--	196
268	207	248	1,158	1,205	919	535	275	177	34	38	52	6,387	8,166
312	249	279	1,364	1,402	1,093	634	313	217	95	49	68	7,559	10,019

SANTA CRUZ COUNTY - TOTAL ARRESTS BY AGE

OFFENSE CLASSIFICATION	UNDER 10	10-12	13-14	15	16	17	TOTAL UNDER 18	18	19	20	21
PART I											
Murder/Nonneg. Manslaughter	--	--	--	--	--	--	--	--	--	--	--
Forcible Rape	--	--	--	--	--	--	--	--	--	--	--
Robbery	--	--	1	1	7	1	10	4	--	1	1
Aggravated Assault	--	1	--	3	8	5	17	8	6	9	5
Burglary	--	1	3	6	8	11	29	11	5	3	4
Larceny-Theft	3	10	13	13	19	16	74	6	12	16	3
Motor Vehicle Theft	--	--	--	1	--	--	1	3	1	2	1
Arson	--	--	5	--	1	--	6	--	--	--	--
PART I SUBTOTAL	3	12	22	24	43	33	137	32	24	31	19
PART II											
Manslaughter by Negligence	--	--	--	--	--	--	--	--	--	--	--
Other Assaults - Simple	--	1	7	2	5	10	25	4	--	3	--
Forgery and Counterfeiting	--	--	--	--	--	--	--	--	--	--	--
Fraud	--	--	--	--	--	--	--	--	--	--	--
Embezzlement	--	--	--	--	--	--	--	--	--	--	--
Stolen Property	--	1	2	2	6	4	15	1	2	4	1
Vandalism	--	--	1	--	1	--	2	1	--	--	--
Weapons: Carrying, Possessing, Etc.	--	--	1	--	3	1	5	1	--	1	--
Prostitution and Comm. Vice	--	--	--	--	--	--	--	--	--	--	--
Sex Offenses	--	--	--	2	--	--	2	--	--	1	--
DRUGS, SALE OR MFG.											
Opium, Cocaine, Derivatives	--	--	--	--	--	--	--	--	--	--	--
Marijuana	--	--	2	--	3	1	6	--	--	--	--
Synthetic Narcotics	--	--	--	--	--	--	--	--	--	--	--
Other Dangerous Nonnarcotics	--	--	--	--	--	--	--	--	--	--	--
DRUGS, POSSESSION											
Opium, Cocaine, Derivatives	--	--	1	3	1	2	7	3	1	1	1
Marijuana	--	--	4	2	3	5	14	10	9	3	5
Synthetic Narcotics	--	--	--	--	--	--	--	--	--	--	--
Other Dangerous Nonnarcotics	--	--	--	--	--	--	--	--	--	--	--
All Gambling											
Offenses Against Family/Children	--	--	--	--	--	--	--	1	--	--	--
Driving Under the Influence	--	--	--	--	1	2	3	1	3	10	5
Liquor Law Violations	--	--	--	--	--	--	--	--	--	--	--
Disorderly Conduct	1	2	7	2	7	4	23	5	4	9	5
Vagrancy	--	--	--	--	--	--	--	--	--	--	--
All Other, Except Traffic	--	6	9	4	8	16	43	5	16	25	20
Curfew/Loitering (Juvenile)	--	--	--	--	--	--	--	--	--	--	--
Runaways (Juvenile)	--	--	--	--	--	--	--	--	--	--	--
PART II SUBTOTAL	1	10	34	17	38	45	145	32	36	62	37
TOTAL	4	22	56	41	81	78	282	64	60	93	56

SANTA CRUZ COUNTY - TOTAL ARRESTS BY AGE (CONT.)

22	23	24	25-29	30-34	35-39	40-44	45-49	50-54	55-59	60-64	65 AND OVER	TOTAL OVER 18	TOTAL ALL AGES
--	--	--	--	--	--	--	--	--	--	--	--	--	--
--	--	--	--	--	--	--	--	--	--	--	--	--	--
1	--	--	2	--	1	--	--	--	--	--	--	10	20
5	3	3	11	9	4	5	2	2	3	--	--	75	92
2	8	3	15	12	6	2	--	--	--	--	--	71	100
13	7	6	31	39	27	15	6	5	2	3	1	197	271
1	1	--	6	4	1	--	--	--	--	--	--	20	21
--	--	--	--	--	--	--	--	--	--	--	--	--	6
22	19	12	65	64	39	22	8	7	5	3	1	373	510
--	--	--	--	--	--	--	--	--	--	--	--	--	--
1	5	6	16	27	13	13	13	3	--	--	--	110	135
--	--	--	--	--	--	--	--	--	--	--	--	--	--
--	--	--	--	--	--	--	--	--	--	--	--	--	--
1	5	2	6	3	--	--	--	--	--	--	--	25	40
--	--	--	--	--	--	--	--	--	--	--	--	--	3
--	1	1	5	2	1	--	--	--	--	--	--	12	17
--	--	--	--	--	--	--	--	--	--	--	--	--	--
--	--	1	--	--	1	2	--	--	1	--	--	6	31
--	--	--	--	--	--	--	--	--	--	--	--	--	--
--	--	--	--	--	--	--	--	--	--	--	--	--	6
--	--	--	--	--	--	--	--	--	--	--	--	--	--
--	--	--	--	--	--	--	--	--	--	--	--	--	--
--	--	--	5	3	2	--	--	--	--	--	--	18	25
7	6	7	21	18	13	2	2	--	1	--	--	104	118
--	--	--	--	--	--	--	--	--	--	--	--	--	--
--	--	--	--	--	--	--	--	--	--	--	--	--	--
--	--	--	--	--	--	--	--	--	--	--	--	--	--
--	--	--	--	1	1	--	--	--	--	1	--	5	5
4	3	6	18	22	14	9	9	6	--	2	1	118	121
--	--	--	--	--	--	--	--	--	--	--	--	--	--
4	1	4	13	15	13	12	4	3	2	--	--	94	117
--	--	--	--	--	--	--	--	--	--	--	--	--	--
20	11	16	76	63	41	25	21	10	3	2	--	354	397
--	--	--	--	--	--	--	--	--	--	--	--	--	--
--	--	--	--	--	--	--	--	--	--	--	--	--	--
37	38	44	160	154	99	63	49	22	8	4	2	847	992
59	57	56	225	218	138	85	57	29	13	7	3	1,220	1,502

YAVAPAI COUNTY - TOTAL ARRESTS BY AGE

OFFENSE CLASSIFICATION	UNDER	10-12	13-14	15	16	17	TOTAL	18	19	20	21
	10						UNDER 18				
PART I											
Murder/Nonneg. Manslaughter	--	--	--	--	--	--	--	--	3	3	2
Forcible Rape	--	3	--	--	--	--	3	--	--	--	2
Robbery	--	--	2	1	--	2	5	--	--	--	--
Aggravated Assault	2	6	16	12	10	15	61	18	13	13	12
Burglary	--	16	37	25	28	22	128	26	6	10	10
Larceny-Theft	8	77	161	88	81	79	494	75	57	49	41
Motor Vehicle Theft	--	2	8	6	8	5	29	2	4	3	--
Arson	--	--	5	--	--	--	5	--	--	--	--
PART I SUBTOTAL	10	104	229	132	127	123	725	122	83	78	68
PART II											
Manslaughter by Negligence	--	--	--	--	--	--	--	--	--	--	--
Other Assaults - Simple	6	17	46	25	36	29	159	25	11	22	20
Forgery and Counterfeiting	1	--	--	5	2	4	12	3	10	8	7
Fraud	--	--	--	--	4	2	6	4	5	4	2
Embezzlement	--	--	--	--	--	--	--	--	--	--	--
Stolen Property	--	--	3	1	3	1	8	1	2	5	--
Vandalism	4	23	40	18	16	17	118	11	7	8	11
Weapons: Carrying, Possessing, Etc.	--	1	10	4	7	9	31	14	3	11	5
Prostitution and Comm. Vice	--	--	--	--	--	--	--	--	--	--	--
Sex Offenses	--	2	--	1	1	3	7	1	3	2	1
DRUGS, SALE OR MFG.											
Opium, Cocaine, Derivatives	1	--	7	4	11	9	32	3	1	3	--
Marijuana	--	2	16	3	3	4	28	12	14	8	15
Synthetic Narcotics	--	--	3	--	3	1	7	11	5	1	--
Other Dangerous Nonnarcotics	--	--	--	--	--	--	--	10	6	3	4
DRUGS, POSSESSION											
Opium, Cocaine, Derivatives	--	--	--	1	1	1	3	3	1	--	3
Marijuana	2	11	21	18	17	17	96	24	43	17	20
Synthetic Narcotics	--	--	2	5	4	4	15	--	2	--	1
Other Dangerous Nonnarcotics	--	--	1	2	--	2	5	--	1	2	3
All Gambling											
Offenses Against Family/Children	--	--	1	1	3	3	8	3	3	1	4
Driving Under the Influence	--	--	--	--	3	5	8	10	21	20	32
Liquor Law Violations	--	6	31	50	48	34	219	31	36	74	14
Disorderly Conduct	--	9	48	24	21	28	130	23	20	18	32
Vagrancy	--	--	--	--	--	--	--	--	--	--	--
All Other, Except Traffic	11	25	72	56	71	81	316	130	176	168	145
Curfew/Loitering (Juvenile)	--	5	25	27	17	19	93	--	--	--	--
Runaways (Juvenile)	3	20	114	71	85	29	322	--	--	--	--
PART II SUBTOTAL	28	121	440	316	356	352	1,613	379	425	375	334
TOTAL	38	225	669	448	483	475	2,338	501	508	453	402

YUMA COUNTY - TOTAL ARRESTS BY AGE

OFFENSE CLASSIFICATION	UNDER 10	10-12	13-14	15	16	17	TOTAL UNDER 18	18	19	20	21
PART I											
Murder/Nonneg. Manslaughter	--	--	--	--	--	--	--	--	--	--	--
Forcible Rape	--	--	--	--	--	--	--	--	--	--	--
Robbery	--	--	--	--	--	--	--	--	--	--	--
Aggravated Assault	1	1	3	5	4	2	16	2	2	--	--
Burglary	--	--	5	2	4	2	13	2	2	2	2
Larceny-Theft	9	3	13	8	5	1	39	11	15	12	3
Motor Vehicle Theft	--	--	--	6	1	4	11	2	1	2	--
Arson	--	--	--	--	--	--	--	--	--	--	--
PART I SUBTOTAL	10	4	21	21	14	9	79	17	20	16	13
PART II											
Manslaughter by Negligence	--	--	--	--	--	--	--	--	--	--	--
Other Assaults - Simple	--	6	17	7	3	3	41	5	4	4	5
Forgery and Counterfeiting	--	--	--	--	1	--	1	--	--	--	--
Fraud	--	--	--	--	--	--	--	--	--	--	--
Embezzlement	--	--	--	--	--	--	--	--	--	--	--
Stolen Property	--	--	--	--	--	--	--	--	--	--	--
Vandalism	11	6	27	16	16	7	83	3	6	4	2
Weapons: Carrying, Possessing, Etc.	--	--	4	1	2	3	10	3	2	2	--
Prostitution and Comm. Vice	--	--	--	--	--	--	--	--	--	--	--
Sex Offenses	--	--	2	--	--	--	2	--	--	--	--
DRUGS, SALE OR MFG.											
Opium, Cocaine, Derivatives	--	--	--	--	--	--	--	--	--	--	--
Marijuana	--	1	2	3	--	--	6	--	--	--	--
Synthetic Narcotics	--	--	--	--	--	--	--	--	--	--	--
Other Dangerous Nonnarcotics	--	--	--	--	--	--	--	--	--	--	--
DRUGS, POSSESSION											
Opium, Cocaine, Derivatives	--	--	2	2	1	3	8	--	--	1	--
Marijuana	--	3	5	1	11	10	30	3	7	6	4
Synthetic Narcotics	--	1	--	--	1	--	2	--	--	--	--
Other Dangerous Nonnarcotics	--	--	--	--	--	--	--	--	1	--	--
All Gambling	--	--	--	--	--	--	--	--	--	--	--
Offenses Against Family/Children	--	--	--	--	--	--	--	--	--	--	--
Driving Under the Influence	--	--	--	--	--	--	--	--	8	1	11
Liquor Law Violations	1	--	2	2	2	6	13	9	18	16	6
Disorderly Conduct	--	5	24	13	20	11	73	7	12	11	5
Vagrancy	--	2	2	1	--	--	5	--	--	--	--
All Other, Except Traffic	--	3	13	5	10	9	40	2	10	12	13
Curfew/Loitering (Juvenile)	--	1	7	7	4	3	22	--	--	--	--
Runaways (Juvenile)	--	4	15	19	9	8	55	--	--	--	--
PART II SUBTOTAL	12	32	122	77	85	63	391	37	68	57	49
TOTAL	22	36	143	98	99	72	470	54	88	73	62

YUMA COUNTY - TOTAL ARRESTS BY AGE

OFFENSE CLASSIFICATION	UNDER 10	10-12	13-14	15	16	17	TOTAL UNDER 18	18	19	20	21
PART I											
Murder/Nonneg. Manslaughter	--	--	--	--	--	--	--	--	--	--	--
Forcible Rape	--	--	--	--	--	--	--	--	--	--	--
Robbery	--	--	--	--	--	--	--	--	--	--	--
Aggravated Assault	1	1	3	5	4	2	16	2	2	--	--
Burglary	--	--	5	2	4	2	13	2	2	2	2
Larceny-Theft	9	3	13	8	5	1	39	11	15	12	3
Motor Vehicle Theft	--	--	--	6	1	4	11	2	1	2	--
Arson	--	--	--	--	--	--	--	--	--	--	--
PART I SUBTOTAL	10	4	21	21	14	9	79	17	20	16	13
PART II											
Manslaughter by Negligence	--	--	--	--	--	--	--	--	--	--	--
Other Assaults - Simple	--	6	17	7	3	3	41	5	4	4	5
Forgery and Counterfeiting	--	--	--	--	1	--	1	--	--	--	--
Fraud	--	--	--	--	--	--	--	--	--	--	--
Embezzlement	--	--	--	--	--	--	--	--	--	--	--
Stolen Property	--	--	--	--	--	--	--	--	--	--	--
Vandalism	11	6	27	16	16	7	83	3	6	4	2
Weapons: Carrying, Possessing, Etc.	--	--	4	1	2	3	10	3	2	2	--
Prostitution and Comm. Vice	--	--	--	--	--	--	--	--	--	--	--
Sex Offenses	--	--	2	--	--	--	2	--	--	--	--
DRUGS, SALE OR MFG.											
Opium, Cocaine, Derivatives	--	--	--	--	--	--	--	--	--	--	--
Marijuana	--	1	2	3	--	--	6	--	--	--	--
Synthetic Narcotics	--	--	--	--	--	--	--	--	--	--	--
Other Dangerous Nonnarcotics	--	--	--	--	--	--	--	--	--	--	--
DRUGS, POSSESSION											
Opium, Cocaine, Derivatives	--	--	2	2	1	3	8	--	--	1	--
Marijuana	--	3	5	1	11	10	30	3	7	6	4
Synthetic Narcotics	--	1	--	--	1	--	2	--	--	--	--
Other Dangerous Nonnarcotics	--	--	--	--	--	--	--	--	1	--	--
All Gambling	--	--	--	--	--	--	--	--	--	--	--
Offenses Against Family/Children	--	--	--	--	--	--	--	--	--	--	--
Driving Under the Influence	--	--	--	--	--	--	--	--	8	1	11
Liquor Law Violations	1	--	2	2	2	6	13	9	18	16	6
Disorderly Conduct	--	5	24	13	20	11	73	7	12	11	5
Vagrancy	--	2	2	1	--	--	5	--	--	--	--
All Other, Except Traffic	--	3	13	5	10	9	40	2	10	12	13
Curfew/Loitering (Juvenile)	--	1	7	7	4	3	22	--	--	--	--
Runaways (Juvenile)	--	4	15	19	9	8	55	--	--	--	--
PART II SUBTOTAL	12	32	122	77	85	63	391	37	68	57	49
TOTAL	22	36	143	98	99	72	470	54	88	73	62

YUMA COUNTY - TOTAL ARRESTS BY AGE (CONT.)

22	23	24	25-29	30-34	35-39	40-44	45-49	50-54	55-59	60-64	65 AND OVER	TOTAL OVER '8	TOTAL ALL AGES
--	--	--	--	--	1	--	--	--	--	--	--	1	1
--	--	--	--	--	--	--	--	--	--	--	--	--	--
--	--	1	--	--	--	--	--	--	--	--	--	1	1
2	3	--	4	2	2	9	1	--	--	--	--	28	44
3	1	3	6	5	1	--	--	--	1	--	--	28	41
5	8	8	49	69	36	12	9	4	2	5	7	260	299
--	1	3	2	1	--	--	--	--	--	--	--	13	24
--	--	--	--	--	--	--	1	--	--	--	--	1	1
10	13	15	61	77	40	21	10	4	3	5	7	332	411
--	--	--	--	--	--	--	--	--	--	--	--	--	--
3	5	8	27	25	17	17	3	1	1	--	3	133	174
1	--	--	4	3	1	--	--	--	--	--	--	10	11
--	--	--	2	--	--	--	--	1	--	--	--	3	3
--	--	--	--	--	--	--	--	--	--	--	--	--	--
--	--	1	2	1	1	2	1	1	1	--	--	25	108
2	--	2	1	2	2	--	--	1	--	--	--	18	29
--	--	--	--	--	--	--	--	--	--	--	--	--	--
--	--	3	1	3	2	1	1	1	1	--	--	13	15
--	--	--	1	--	--	--	--	--	--	--	--	1	1
--	--	--	1	--	--	--	--	--	--	--	--	1	2
--	--	--	--	--	--	--	--	--	--	--	--	--	--
1	1	--	2	2	3	1	1	--	--	--	--	12	20
5	4	7	16	17	6	3	--	1	--	--	--	84	114
--	--	--	4	5	4	--	--	--	--	--	--	14	16
--	--	1	2	--	--	--	1	--	--	--	--	5	5
--	--	--	--	--	--	--	--	--	--	--	--	--	--
--	--	--	--	--	--	1	--	--	--	--	1	2	2
9	8	6	23	38	26	27	18	10	8	2	7	202	202
5	4	--	6	13	9	7	3	6	2	3	2	109	122
10	5	7	35	25	27	22	11	7	6	1	2	193	266
--	--	--	--	1	--	--	--	--	--	--	--	1	6
6	17	13	68	48	31	23	19	3	4	3	2	274	314
--	--	--	--	--	--	--	--	--	--	--	--	--	22
--	--	--	--	--	--	--	--	--	--	--	--	--	55
42	44	48	195	183	129	104	63	32	23	9	17	1,100	1,491
52	57	63	256	260	169	125	73	36	26	14	24	1,432	1,902

POLICE DISPOSITION OF JUVENILES

COUNTY	TOTAL	Handled within Department and Released	Referred to Juvenile Court or Prob. Dept.	Referred to Welfare Agency	Referred to Other Police Agency	Referred to Criminal or Adult Court
APACHE	457	87	367	1	--	2
COCHISE	1,968	154	1,810	--	4	--
COCONINO	2,292	30	2,258	--	4	--
GILA	1,053	49	997	--	5	2
GRAHAM	641	65	573	--	3	--
GREENLEE	141	--	141	--	--	--
LA PAZ	63	4	59	--	--	--
MARICOPA	35,105	5,012	27,670	9	427	1,987
MOHAVE	2,757	--	2,757	--	--	--
NAVAJO	1,245	74	1,166	--	3	2
PIMA	18,075	1,268	16,120	13	41	633
PINAL	2,459	261	2,105	80	7	6
SANTA CRUZ	282	2	275	--	4	1
YAVAPAI	2,632	427	2,185	10	4	6
YUMA	476	152	314	--	10	--
TOTAL	69,646	7,585	58,797	113	512	2,639

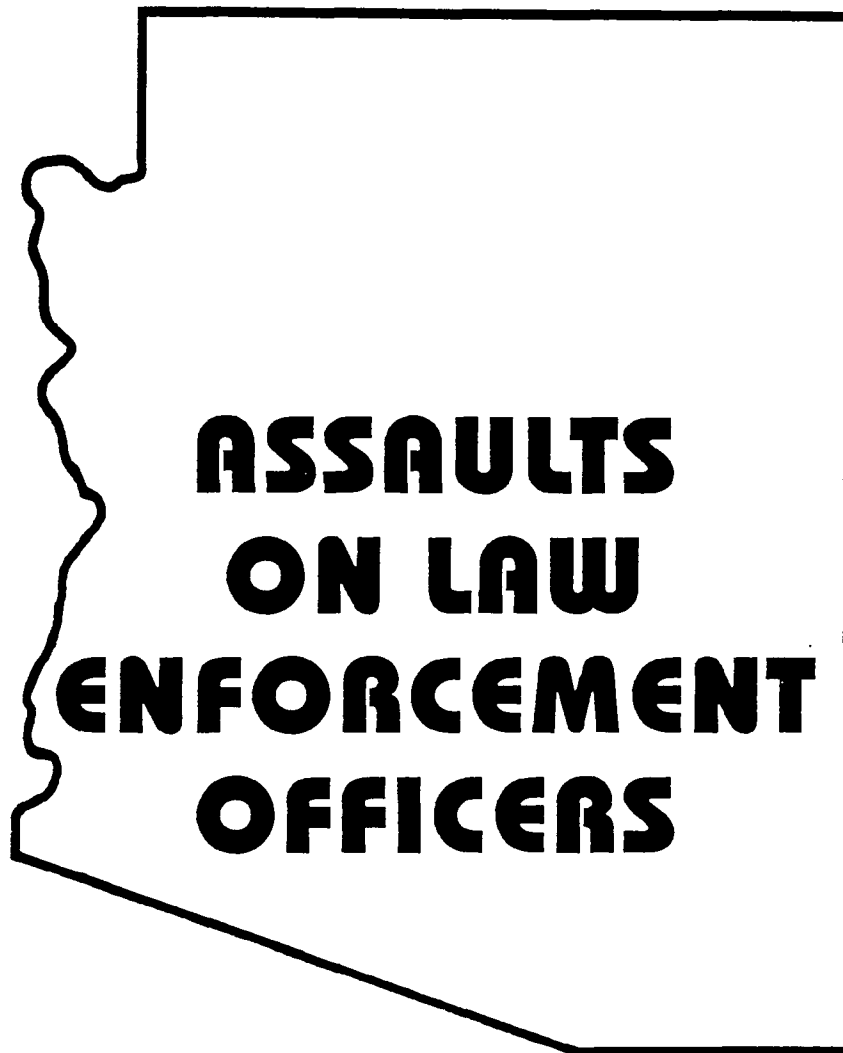

**ASSAULTS
ON LAW
ENFORCEMENT
OFFICERS**

POLICE OFFICER ASSAULTS

DEFINITION

All assaults on sworn officers resulting in serious injury or in which a weapon was used that could have caused serious injury or death. Also included are assaults not causing injury which involved more than mere verbal abuse or minor resistance to arrest.

SUMMARY

- There were a total of 1,786 police officers assaulted statewide in 1995.
- Personal weapons, such as hands, fists, and feet, were used in 1,407 assaults, or 78.8 percent.
- The time period of 10:01 PM to midnight recorded the highest incidence of assaults with 317, or 17.8 percent.
- The highest number of assaults, 642, or 36.0 percent, occurred when officers were responding to disturbance calls.
- Personal injuries were sustained in 305 assaults, or 17.1 percent.

CLEARANCES

- There were 1,481 clearances for assaults on police officers. This represents a clearance rate of 82.9 percent.

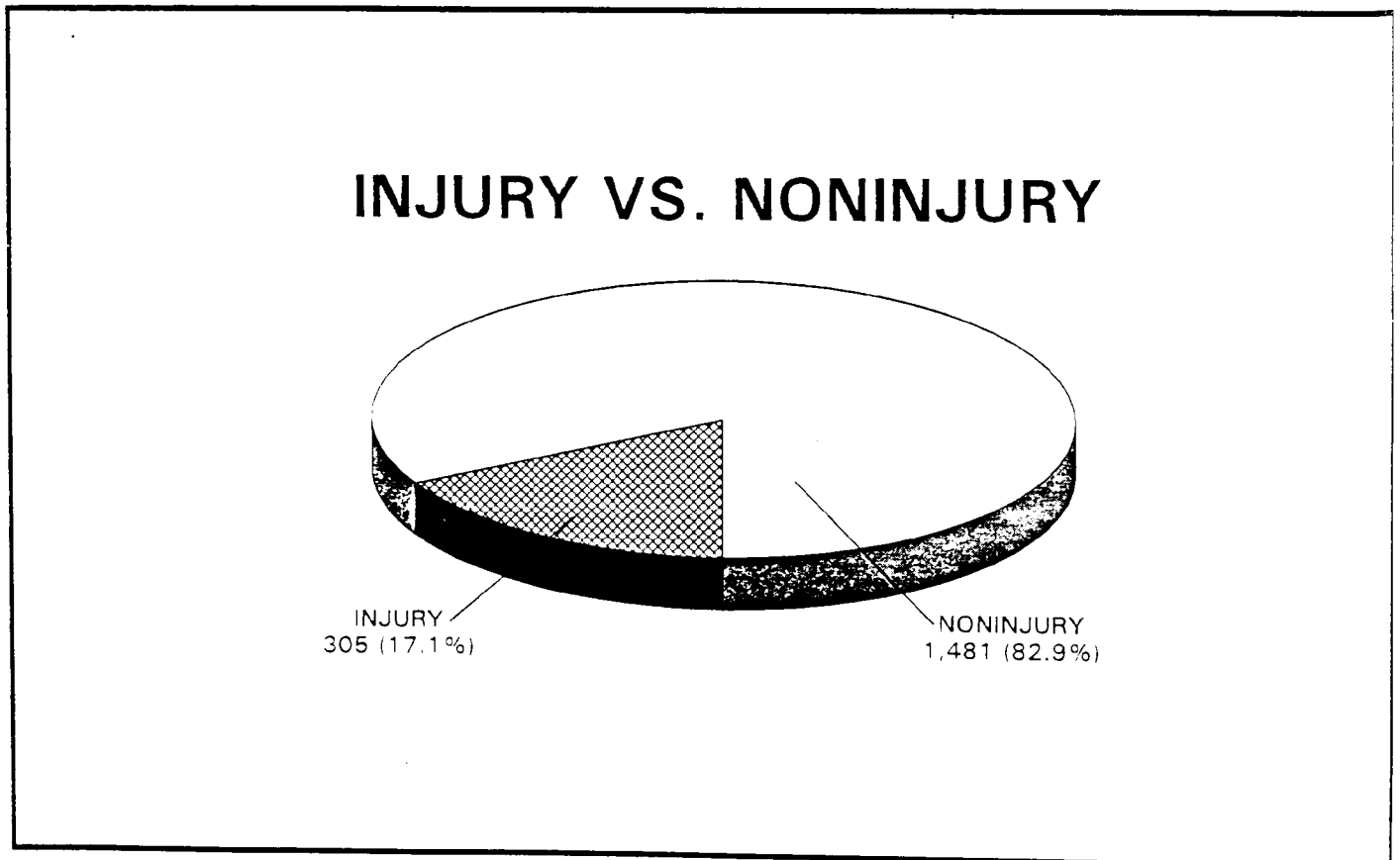

OFFICERS ASSAULTED FREQUENCY DISTRIBUTION

TYPE OF ACTIVITY	TOTAL ASSAULTS BY WEAPON	TYPE OF WEAPON				TYPE OF ASSIGNMENT						POLICE ASSAULTS CLEARED	
		FIREARM	KNIFE OR OTHER CUTTING INSTRUMENT	OTHER DANGEROUS WEAPON	HANDS, FISTS, FEET, ETC.	TWO-MAN VEHICLE	ONE-MAN VEHICLE		DETECTIVE OR SPECIAL ASSIGNMENT		OTHER		
							ALONE	ASSISTED	ALONE	ASSISTED	ALONE		ASSISTED
Responding to "disturbance" calls	642	43	25	52	522	43	73	494	4	7	7	14	614
Burglaries in progress or pursuing burglary suspects	20	--	1	6	13	3	6	9	--	--	--	2	19
Robberies in progress or pursuing robbery suspects	28	17	3	6	2	--	2	14	--	10	--	2	27
Attempting other arrests	250	7	9	14	220	18	49	155	3	13	5	7	244
Civil disorder (Riot, mass disobedience)	15	--	--	2	13	--	1	11	--	1	--	2	15
Handling or transporting of prisoners	241	3	--	10	228	9	46	173	--	1	2	10	237
Investigating suspicious persons or circumstances	126	12	7	15	92	2	21	89	--	10	--	4	117
Ambush - No warning	17	11	--	4	2	6	5	6	--	--	--	--	17
Mentally deranged	15	--	--	--	15	--	5	10	--	--	--	--	15
Traffic pursuits and stops	178	20	--	41	117	20	45	103	1	3	1	--	157
All Other	254	27	9	35	183	22	38	136	4	25	13	16	225
TOTAL	1,786	140	54	185	1,407	123	291	1,200	12	75	28	57	1,673
Number with personal injury	305	10	5	42	247								
Number without personal injury	1,481	130	48	143	1,160								

OFFICERS ASSAULTED FREQUENCY DISTRIBUTION

TYPE OF ACTIVITY	TOTAL ASSAULTS BY WEAPON	TYPE OF WEAPON				TYPE OF ASSIGNMENT						POLICE ASSAULTS CLEARED	
		FIREARM	KNIFE OR OTHER CUTTING INSTRUMENT	OTHER DANGEROUS WEAPON	HANDS, FISTS, FEET, ETC.	TWO-MAN VEHICLE	ONE-MAN VEHICLE		DETECTIVE OR SPECIAL ASSIGNMENT		OTHER		
							ALONE	ASSISTED	ALONE	ASSISTED	ALONE		ASSISTED
Responding to "disturbance" calls	642	43	25	52	522	43	73	494	4	7	7	14	614
Burglaries in progress or pursuing burglary suspects	20	--	1	6	13	3	6	9	--	--	--	2	19
Robberies in progress or pursuing robbery suspects	28	17	3	6	2	--	2	14	--	10	--	2	27
Attempting other arrests	250	7	9	14	220	18	49	155	3	13	5	7	244
Civil disorder (Riot, mass disobedience)	15	--	--	2	13	--	1	11	--	1	--	2	15
Handling or transporting of prisoners	241	3	--	10	228	9	46	173	--	1	2	10	237
Investigating suspicious persons or circumstances	126	12	7	15	92	2	21	89	--	10	--	4	117
Ambush - No warning	17	11	--	4	2	6	5	6	--	--	--	--	17
Mentally deranged	15	--	--	--	15	--	5	10	--	--	--	--	15
Traffic pursuits and stops	178	20	--	41	117	20	45	103	1	3	1	--	157
All Other	254	27	9	35	183	22	38	136	4	25	13	16	225
TOTAL	1,786	140	54	185	1,407	123	291	1,200	12	75	28	57	1,673
Number with personal injury	305	10	5	42	247								
Number without personal injury	1,481	130	48	143	1,160								

OFFICERS ASSAULTED DISTRIBUTION BY COUNTY

COUNTY	NUMBER OF ASSAULTS	WITH INJURY	WITHOUT INJURY	PERCENT DISTRIBUTION	CLEARANCE
Apache	2	--	2	0.1%	2
Cochise	5	2	3	0.3%	5
Coconino	7	4	3	0.4%	7
Gila	7	--	7	0.4%	4
Graham	1	1	--	0.1%	1
Greenlee	--	--	--	--	--
La Paz	1	1	--	0.1%	--
Maricopa	1,294	164	1,130	72.4%	1,210
Mohave	17	5	12	1.0%	12
Navajo	8	6	2	0.4%	3
Pima	384	100	284	21.5%	370
Pinal	18	8	10	1.0%	16
Santa Cruz	2	--	2	0.1%	2
Yavapai	35	11	24	1.9%	32
Yuma	5	3	2	0.3%	4
TOTAL	1,786	305	1,481	100.0%	1,673

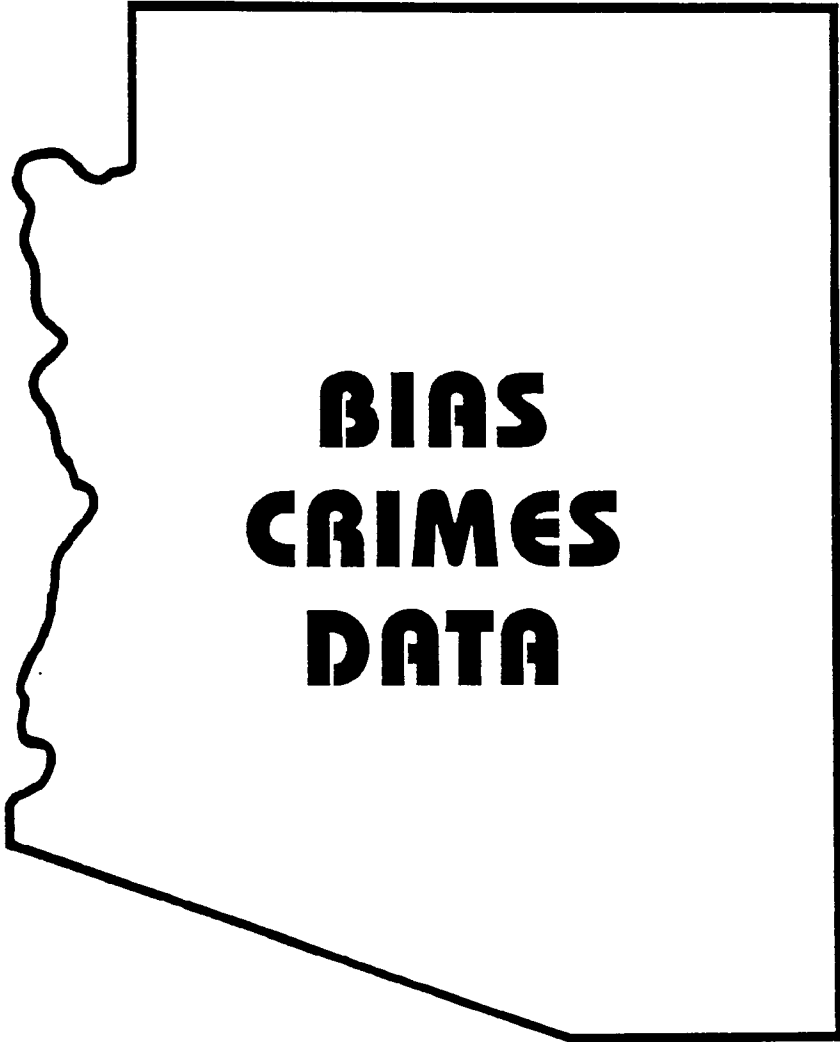

**BIAS
CRIMES
DATA**

BIAS (HATE) CRIME DATA COLLECTION

BACKGROUND

The collection of bias (hate) crime statistics is the latest addition to the Uniform Crime Reporting program. It reflects a growing concern on both a federal and state level to the problem of crimes being committed due to bias or hate.

The collection of these statistics began with the passage of Public Law 101-275, known as the Hate Crime Statistics Act, in April 1990. The Act required the Attorney General to establish guidelines and collect data "about crimes that manifest evidence of prejudice based on race, religion, sexual orientation, or ethnicity, including where appropriate the crimes of murder, non-negligent manslaughter; forcible rape; aggravated assault, simple assault, intimidation; arson; and destruction, damage or vandalism of property."

In Arizona, legislation mandating the collection of bias (hate) crime statistics was passed in 1991. Arizona Revised Statutes 41-1750 was amended in part to read that the criminal identification section within the Department of Public Safety shall "Collect information concerning criminal offenses that manifest evidence of prejudice based on race, color, religion, national origin, sexual orientation, gender or disability."

Statewide collection began January 1992. Statistics received from Arizona law enforcement agencies for 1995 are listed on the following pages.

BIAS OFFENSES - FOUR YEAR COMPARISON

OFFENSE	1992	1993	1994	1995
Homicide	--	--	1	--
Forcible Rape	1	--	--	--
Robbery	--	3	7	3
Aggravated Assault	38	45	38	42
Simple Assault	49	50	29	47
Burglary	2	3	6	3
Larceny-Theft	--	--	--	--
Motor Vehicle Theft	--	--	--	--
Arson	--	1	4	1
Intimidation	66	55	66	66
Destruction/Damage/Vandalism	23	59	64	57
TOTAL	179	216	215	230

BIAS (HATE) CRIMES

DEFINITION

A criminal offense committed against a person or property which is motivated, in whole or in part, by the offender's bias against a race, religion, ethnic/national origin group, sexual orientation group, gender, or disability.

SUMMARY

- There were 220 actual incidents of bias crimes reported in 1995 involving 230 offenses.
- Intimidation accounted for 66 offenses, or 28.7 percent, followed by vandalism with 57 offenses and aggravated assault with 42 offenses.
- The residence/home accounted for the most frequent location of occurrence of bias offenses with 88 or 38.3 percent.
- Racial bias accounted for 139 of all bias offenses, or 60.4 percent, followed by sexual bias with 43 offenses or 18.7 percent.
- The most frequently reported known suspected offenders' race was white, reported in 118 incidents, or 53.6 percent, followed by black with 25, and multi-racial group with 3. In 74 bias incidents, the suspected offenders' race was reported as unknown.

BIAS OFFENSES BY QUARTER - 1995

OFFENSE	1ST	2ND	3RD	4TH	TOTAL
Homicide	--	--	--	--	--
Forcible Rape	--	--	--	--	--
Robbery	3	2	3	--	8
Aggravated Assault	15	11	6	10	42
Simple Assault	13	7	14	13	47
Burglary	--	2	3	3	8
Larceny-Theft	--	--	1	--	1
Motor Vehicle Theft	--	--	--	--	--
Arson	1	--	--	--	1
Intimidation	16	18	22	10	66
Destruction/Damage/Vandalism	20	15	17	5	57
TOTAL	68	55	66	41	230

BIAS OFFENSE LOCATIONS BY QUARTER - 1995

LOCATION	1ST	2ND	3RD	4TH	TOTAL
Air/Bus/Train Terminal	2	2	--	1	5
Bank/Savings and Loan	--	--	--	--	--
Bar/Night Club	1	3	1	1	6
Church/Synagogue/Temple	4	3	1	2	10
Commercial/Office Building	2	2	5	2	11
Construction Site	--	--	1	--	1
Convenience Store	1	--	--	2	3
Department/Discount Store	1	--	--	--	1
Drug Store/Doctor's Office/Hospital	1	--	--	--	1
Field/Woods	1	--	--	--	1
Government/Public Building	2	1	1	--	4
Grocery/Supermarket	--	--	1	1	2
Highway/Road/Alley/Street	14	12	12	11	49
Hotel/Motel/Etc.	--	--	--	--	--
Jail/Prison	--	--	--	--	--
Lake/Waterway	--	--	--	--	--
Liquor Store	--	--	--	--	--
Parking Lot/Garage	10	1	4	2	17
Rental Storage Facility	--	--	--	--	--
Residence/Home	21	21	33	13	88
Restaurant	--	1	2	2	5
School/College	4	4	4	4	16
Service/Gas Station	1	1	--	--	2
Specialty Store	--	--	--	--	--
Other/Unknown	3	4	1	--	8
TOTAL	68	55	66	41	230

BIAS MOTIVATION BY QUARTER - 1995

TYPE OF BIAS	1ST	2ND	3RD	4TH	TOTAL
RACIAL					
Anti-White	4	12	7	4	27
Anti-Black	31	17	29	15	92
Anti-American Indian/Alaskan Native	--	--	--	2	2
Anti-Asian/Pacific Islander	1	2	2	4	9
Anti-Multi-Racial Group	--	3	6	--	9
ETHNIC/NATIONAL ORIGIN					
Anti-Arab	--	1	1	2	4
Anti-Hispanic	4	3	4	6	17
Anti-Other Ethnic/National Origin	2	--	1	--	3
RELIGIOUS					
Anti-Jewish	6	5	6	1	18
Anti-Catholic	2	1	--	--	3
Anti-Protestant	1	--	--	--	1
Anti-Islamic	--	--	--	--	--
Anti-Other Religion	1	--	--	1	2
Anti-Multi-Religious Group	--	--	--	--	--
Anti-Atheism/Agnosticism/Etc.	--	--	--	--	--
SEXUAL					
Anti-Male Homosexual	14	11	10	5	40
Anti-Female Homosexual	2	--	--	1	3
Anti-Homosexual	--	--	--	--	--
Anti-Heterosexual	--	--	--	--	--
Anti-Bisexual	--	--	--	--	--
TOTAL	68	55	66	41	230

BIAS OFFENSES BY COUNTY - 1995

COUNTY	1ST	2ND	3RD	4TH	TOTAL
Apache	--	--	--	--	--
Cochise	4	1	--	--	5
Coconino	--	--	3	--	3
Gila	--	--	--	--	--
Graham	--	--	--	--	--
Greenlee	--	--	--	--	--
La Paz	--	--	--	--	--
Maricopa	51	45	53	33	182
Mohave	1	--	1	2	4
Navajo	1	--	--	--	1
Pima	8	6	9	6	29
Pinal	--	2	--	--	2
Santa Cruz	--	--	--	--	--
Yavapai	2	1	--	--	3
Yuma	1	--	--	--	1
TOTÁL	68	55	66	41	230

BIAS OFFENSES BY AGENCY - 1995

AGENCY	1ST	2ND	3RD	4TH	TOTAL
Apache Junction PD	--	1	--	--	1
Bisbee PD	2	--	--	--	2
Buckeye PD	--	--	--	1	1
Bullhead City PD	--	--	1	2	3
Chandler PD	2	--	1	--	3
Coolidge PD	--	1	--	--	1
Flagstaff PD	--	--	3	--	3
Gilbert PD	--	2	--	--	2
Glendale PD	4	3	1	1	9
Lake Havasu City PD	1	--	--	--	1
Marana PD	--	--	--	1	1
Maricopa County SO	--	--	1	--	1
Mesa PD	1	6	6	5	18
Paradise Valley PD	1	--	1	--	2
Peoria PD	--	--	1	--	1
Phoenix PD	40	28	36	21	125
Pima County SO	3	6	9	5	23
Pinetop-Lakeside PD	1	--	--	--	1
Prescott PD	1	--	--	--	1
Prescott Valley PD	1	1	--	--	2
Scottsdale PD	2	4	5	2	13
Sierra Vista PD	2	--	--	--	2
Tempe PD	1	2	1	3	7
Tombstone MO	--	1	--	--	1
Tucson PD	5	--	--	--	5
Yuma County SO	1	--	--	--	1
TOTAL	68	55	66	41	230



**FULL-TIME
LAW
ENFORCEMENT
EMPLOYEES**

FULL-TIME LAW ENFORCEMENT EMPLOYEES

DEFINITION

The following chart reflects full-time law enforcement personnel employed as of October 31, 1995. These figures include full-time sworn personnel with full arrest powers; however they do not include persons performing guard or protection duties, such as school crossing guards, nor reserve officers. Civilian employees include clerks, dispatchers, secretaries, etc. who are employed full-time and are paid from law enforcement funds or budget.

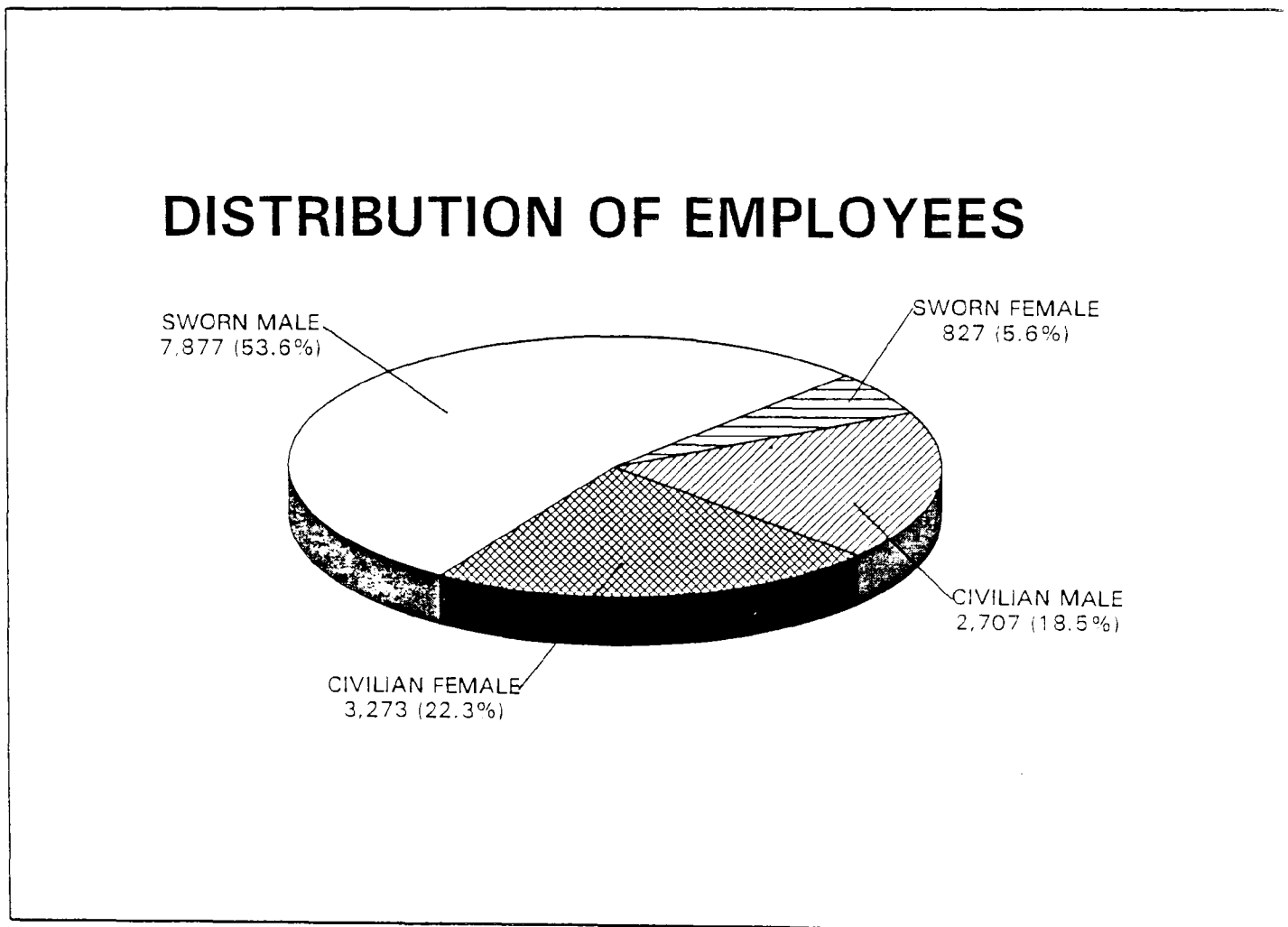

NUMBER OF EMPLOYEES BY AGENCY

AGENCY	SWORN		CIVILIAN		TOTAL	POPULATION
	MALE	FEMALE	MALE	FEMALE		
APACHE COUNTY SO	27	1	14	13	55	54,505
APACHE JUNCTION PD	42	3	3	14	62	19,525
AVONDALE PD	38	2	5	7	52	23,950
BENSON PD	12	--	2	5	19	4,115
BISBEE PD	13	1	1	5	20	5,500
BUCKEYE PD	15	2	2	5	24	5,130
BULLHEAD CITY PD	54	2	4	32	92	26,940
CAMP VERDE MO	12	2	3	5	22	7,465
CASA GRANDE PD	46	3	7	16	72	20,880
CHANDLER PD	173	7	12	52	244	128,035
CHINO VALLEY PD	11	1	--	6	18	6,365
CLARKDALE PD	9	--	--	2	11	2,600
CLIFTON PD	6	--	1	3	10	2,995
COCHISE COUNTY SO	61	3	64	33	161	42,530
COCONINO COUNTY SO	51	7	32	33	123	44,765
COLORADO CITY MO	4	--	--	--	4	3,190
COOLIDGE PD	18	1	--	6	25	7,055
COTTONWOOD PD	20	1	7	6	34	6,545
DOUGLAS PD	31	2	4	8	45	14,780
EAGAR PD	7	--	1	1	9	4,515
EL MIRAGE PD	11	1	1	3	16	5,355
ELOY PD	20	1	8	3	32	8,915
FLAGSTAFF PD	76	5	8	28	117	52,745
FLORENCE PD	10	2	1	5	18	11,440
FOUNTAIN HILLS MO	4	--	1	1	6	13,100
FREDONIA MO	2	--	--	1	3	1,250
GILA COUNTY SO	48	2	23	35	108	24,100
GILBERT PD	57	10	3	24	94	54,935
GLENDALE PD	207	23	32	63	325	172,155
GLOBE PD	21	2	1	7	31	7,075
GOODYEAR PD	21	1	--	9	31	9,595
GRAHAM COUNTY SO	13	2	8	7	30	15,320
GREENLEE COUNTY SO	15	--	8	2	25	5,455
HAYDEN PD	5	--	--	1	6	910
HOLBROOK PD	15	2	--	5	22	5,070
HUACHUCA CITY PD	6	--	--	6	12	1,940
JEROME PD	3	--	--	--	3	460
KEARNY PD	6	2	1	3	12	2,455
KINGMAN PD	34	5	2	16	57	16,775
LA PAZ COUNTY SO	30	2	21	22	75	11,595
LAKE HAVASU CITY PD	55	3	5	15	78	36,285
MAMMOTH PD	4	--	--	6	10	1,960
MARANA PD	29	4	1	7	41	5,160
MARICOPA COUNTY SO	417	28	760	491	1,696	205,915
MESA PD	496	54	81	198	829	328,735
MIAMI PD	5	1	1	2	9	2,040
MOHAVE COUNTY SO	80	7	75	52	214	41,310
NAVAJO COUNTY SO	43	4	18	22	87	51,355
NOGALES PD	51	1	7	10	69	20,655
ORO VALLEY PD	35	3	3	12	53	15,885
PAGE PD	18	2	3	12	35	7,950

NUMBER OF EMPLOYEES BY AGENCY (CONTINUED)

AGENCY	SWORN		CIVILIAN		TOTAL	POPULATION
	MALE	FEMALE	MALE	FEMALE		
PARADISE VALLEY PD	29	--	4	5	38	12,930
PARKER PD	11	--	--	2	13	2,950
PATAGONIA MO	3	--	--	--	3	945
PAYSON PD	23	1	1	8	33	9,950
PEORIA PD	64	7	5	25	101	69,970
PHOENIX PD	1,941	242	271	534	2,988	1,082,610
PIMA COUNTY SO	327	58	401	247	1,033	284,360
PIMA PD	2	--	--	--	2	1,375
PINAL COUNTY SO	122	12	64	60	258	63,335
PINETOP-LAKESIDE PD	14	1	2	4	21	2,515
PRESCOTT PD	47	6	8	19	80	30,270
PRESCOTT VALLEY PD	21	1	1	7	30	16,120
QUARTZSITE MO	6	--	--	1	7	2,005
SAFFORD PD	16	1	1	1	19	8,855
ST. JOHNS PD	5	--	--	1	6	3,360
SAN LUIS PD	17	1	2	3	23	3,100
SANTA CRUZ COUNTY SO	36	2	15	11	64	12,275
SCOTTSDALE PD	225	24	53	91	393	163,700
SEDONA PD	18	1	2	6	27	3,910
SHOW LOW PD	18	1	1	10	30	5,830
SIERRA VISTA PD	34	2	3	15	54	37,815
SNOWFLAKE-TAYLOR PD	11	--	1	--	12	6,775
SOMERTON PD	11	1	2	3	17	5,850
SOUTH TUCSON PD	21	2	2	6	31	5,570
SPRINGERVILLE PD	6	--	--	1	7	1,920
SUPERIOR PD	5	2	--	4	11	3,485
SURPRISE PD	23	2	--	2	27	10,510
TEMPE PD	236	26	37	78	377	155,610
THATCHER PD	9	--	--	1	10	3,975
TOLLESON PD	11	1	3	3	18	4,650
TOMBSTONE MO	5	1	--	1	7	1,315
TUCSON PD	721	113	55	197	1,086	447,075
WELLTON MO	4	--	--	--	4	1,130
WICKENBURG PD	9	--	3	2	14	4,965
WILLCOX PD	10	--	--	5	15	3,305
WILLIAMS PD	10	--	1	5	16	2,590
WINSLOW PD	18	2	--	9	29	10,780
YAVAPAI COUNTY SO	84	5	44	49	182	50,765
YOUNGTOWN PD	7	2	1	4	14	2,675
YUMA COUNTY SO	50	3	97	46	196	46,320
YUMA PD	99	12	10	43	164	60,475
Agencies with no measurable population						
AZ DEPT OF PUBLIC SAFETY	304	66	327	389	1,686	
AZ STATE CAPITOL PD	25	1	26	6	58	
AZ STATE UNIV DPS	35	7	4	15	61	
AZ STATE UNIV WEST DPS	8	--	6	2	16	
AZ WESTERN COLLEGE PD	5	3	--	1	9	
CENTRAL AZ COLLEGE PD	5	1	--	--	6	
NORTHERN AZ UNIV PD	16	3	4	8	31	
PIMA COLLEGE PD	23	2	2	8	35	
UNIV OF AZ PD	38	5	14	15	72	
YAVAPAI COLLEGE PD	2	2	--	--	4	

GLOSSARY

ADULT	For UCR, a person aged 18 or over.
AMERICAN INDIAN or ALASKAN NATIVE	A person having origins in any of the original peoples of North America, and who maintains cultural identification through tribal affiliation or community recognition.
ASIAN or PACIFIC ISLANDER	A person having origins in any of the original peoples of the Far East, Southeast Asia, the Indian subcontinent, or the Pacific Islands. This area includes for example: China, India, Japan, Korea, the Philippine Islands, and Samoa.
BLACK	A person having origins in any of the black racial groups of Africa, characterized by dark skin pigmentation.
CLEARED BY ARREST	An offense that is cleared (solved) when at least one person is arrested, charged with the commission of the offense, and turned over to the court for prosecution.
CRIMES AGAINST PERSONS	Includes the following Index offenses: Murder, rape and aggravated assault.
CRIME INDEX	Total of eight offenses used to measure the extent, fluctuation and distribution of crime in a given geographical area. The Crime Index includes: Murder, rape, robbery, aggravated assault, burglary, larceny-theft, motor vehicle theft and arson.
EXCEPTIONAL CLEARANCE	An offense that is cleared when an offender has been identified, located, and there is some reason beyond law enforcement control which prohibits bringing the offender to court.
HIERARCHY RULE	A UCR scoring practice used in multiple offense situations where only the most serious offense (as determined by the established crime index order) is counted.
HISPANIC	A person of Mexican, Cuban, Central or South American, or other Spanish culture or origin, regardless of race.
JUVENILE	For UCR, any person under the age of 18.
JUVENILE CLEARANCE	Offenses involving only persons under the age of 18 that are cleared by arrest or exceptional means.
NONVIOLENT CRIME	Any of the following Index offenses: Burglary, larceny-theft, motor vehicle theft and arson.
VIOLENT CRIME	Any of the following Index offenses: Murder, rape, robbery and aggravated assault.
WHITE	A person having origins in any of the original peoples of Europe, North Africa or the Middle East.