

FD-7.7
454
994 7A
AZDOC

1994

ARIZ SONIT DOCS

CRIME

DEC 27 1995

ASU LIBRARY

IN

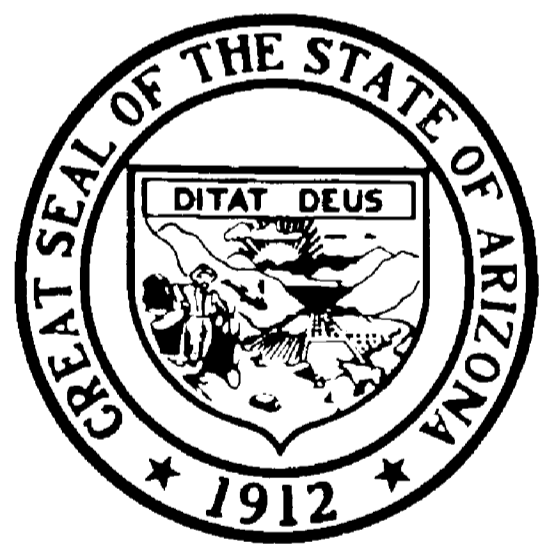

ARIZONA

CRIME IN ARIZONA 1994

*An annual report compiled by
the Arizona Department of Public Safety*

Joe Albo
Director
Arizona Department of Public Safety



Arizona Department of Public Safety, 2102 West Encanto Boulevard, P. O. Box 6638, Phoenix, Arizona 85005-6638

ARIZONA DEPARTMENT OF PUBLIC SAFETY

2102 WEST ENCANTO BLVD. P. O. BOX 6638 PHOENIX, ARIZONA 85005-6638 (602) 223-2000

FIFE SYMINGTON
GOVERNOR

JOE ALBO
DIRECTOR

FOREWORD

The Arizona Department of Public Safety is pleased to participate in and serve as the coordinating agency for the Arizona Crime Reporting Program.

The purpose of the 1994 "Crime in Arizona" is to provide data regarding the nature and extent of crime throughout the state. This report does not draw conclusions as to the causes of crime. However, it does provide the vital information necessary to assist law enforcement agencies, government, and the public in their approach to crime in our state.

This report is the culmination of a joint effort by our state's law enforcement agencies to collect and organize crime data. The information contained in this report should provide a valuable overview of the crime problem.

This is also the third year that data concerning the nature and extent of bias (hate) crimes has been included. Again, this information does not draw conclusions as to the causes of crimes committed due to bias, but it is an additional resource that can be utilized by the citizens of Arizona.

Sincere appreciation is expressed to all Arizona law enforcement agencies without whose cooperation this publication would not be possible.

JOE ALBO
Director

TABLE OF CONTENTS

DEDICATION	1
ACKNOWLEDGEMENT	2
THE ARIZONA UNIFORM CRIME REPORTING SYSTEM	
History of Uniform Crime Reporting	4
Objectives of Arizona UCR	4
Considerations for Interpretation	4
Population Grouping	6-7
SUMMARY OF STATE CRIME DATA	
Arizona Crime Clock	10
Arizona Crime Cycle	11
State Crime Summary	12
Total Index Crimes by Month	14
Index Crimes Cleared	14
Index Crime Comparison	15
Value of Property Loss by Index Crime Offense	16
Type and Value of Property Stolen and Recovered	16
PART I INDEX CRIMES	
Murder	19
Definition and Summary	19
Murder by Population Group	19
Murder by Month	20
Murder by Day of Week	20
Murder by Time of Day	21
Murder Distribution by Circumstance	21
Murder by Type of Weapon Used	22
Murder by Type of Weapon Used	22
Murder Distribution by Relationship	22
Murder Victim by Age, Sex, Race and Ethnic Origin	23
Rape	24
Definition and Summary	24
Rape by Population Group	24
Rape by Month	25
Robbery	26
Definition and Summary	26
Robbery by Population Group	26
Robbery by Location and Value	27
Robbery by Month and Weapon Used	27
Aggravated Assault	28
Definition and Summary	28
Assault by Population Group	28
Assault by Weapon Used	29
Assault by Month	29
Burglary	30
Definition and Summary	30
Burglary by Population Group	30
Burglary by Location and Time	31
Burglary by Month and Means of Entry	31

TABLE OF CONTENTS

Larceny-Theft	32
Definition and Summary	32
Larceny-Theft by Population Group	32
Larceny-Theft by Type by Month	33
Larceny-Theft by Value by Month	33
Larceny-Theft by Classification and Value	34
Additional Analysis	34
Motor Vehicle Theft	35
Definition and Summary	35
Motor Vehicle Theft by Population Group	35
Motor Vehicle Theft by Month	36
Stolen Vehicles by Type	36
Motor Vehicle Recovery Information	37
Arson	38
Definition and Summary	38
Arson by Population Group	38
Arson by Property Classification	39
Value of Property Damaged	39
Arson Offenses by Property Type by Month	40
COUNTY OFFENSE AND SUPPLEMENTAL DATA	
Index Crimes by County	43
Analysis of Robbery, Burglary, and Larceny-Theft by County	44
Value, in Dollars, of Property Stolen by Crime by County	45
Type and Value, in Dollars, of Property Stolen and Recovered by County	46
STATE AND COUNTY ARREST DATA	
Arrest Summary and Arrest by Age Group	48
Arrest by Offense, Race and Ethnic Origin	49
Total Arrests by Age	50
Juvenile Male Arrests	52
Juvenile Female Arrests	53
Adult Male Arrests	54
Adult Female Arrests	55
Total Arrests by County	56
Adult Arrests by County	57
Juvenile Arrests by County	58
Police Disposition of Juveniles	59
ASSAULTS ON LAW ENFORCEMENT OFFICERS	
Definition and Summary	62
Injury vs. Noninjury	62
Weapons Used	63
Time of Day	63
Officers Assaulted Frequency Distribution	64
Officers Assaulted Distribution by County	65
BIAS CRIMES DATA	68-71
FULL-TIME LAW ENFORCEMENT EMPLOYEES	
Definition	74
Distribution of Employees	74
Number of Employees by Agency	75-76
GLOSSARY	77

**This publication is dedicated to those Arizona Law Enforcement
Officers who gave their lives in the line of duty during 1994.**

**Officer Steve Pollard
Mesa Police Department
November 27, 1994**

**We also wish to remember the following "four-footed officer"
who gave his life in the line of duty during 1994.**

**K-9 Dax
Phoenix Police Department
October 20, 1994**



Acknowledgement

Appreciation is expressed to the agencies listed below. The monthly Uniform Crime Reporting (UCR) information submitted by these agencies served as the basis for this publication.

Apache County Sheriff's Office
Apache Junction Police Department
Arizona Department of Public Safety
AZ State University Police Department
AZ State University West Police Department
AZ Western College Police Department
Avondale Police Department
Benson Police Department
Bisbee Police Department
Buckeye Police Department
Bullhead City Police Department
Camp Verde Marshal's Office
Casa Grande Police Department
Central AZ College Police Department
Chandler Police Department
Chino Valley Police Department
Clarkdale Police Department
Cochise County Sheriff's Office
Coconino County Sheriff's Office
Coolidge Police Department
Cottonwood Police Department
Douglas Police Department
Eagar Police Department
El Mirage Police Department
Eloy Police Department
Flagstaff Police Department
Florence Police Department
Gila County Sheriff's Office
Gilbert Police Department
Glendale Police Department
Globe Police Department
Goodyear Police Department
Graham County Sheriff's Office
Greenlee County Sheriff's Office
Hayden Police Department
Holbrook Police Department
Huachuca City Police Department
Jerome Police Department
Kearny Police Department
Kingman Police Department
Lake Havasu City Police Department
La Paz County Sheriff's Office
Mammoth Police Department
Marana Police Department
Maricopa County Sheriff's Office
Mesa Police Department
Miami Police Department
Mohave County Sheriff's Office

Navajo County Sheriff's Office
Nogales Police Department
Northern AZ University Police Department
Oro Valley Police Department
Page Police Department
Paradise Valley Police Department
Parker Police Department
Payson Police Department
Peoria Police Department
Phoenix Police Department
Pima College Police Department
Pima County Sheriff's Office
Pima Police Department
Pinal County Sheriff's Office
Pinetop-Lakeside Police Department
Prescott Police Department
Prescott Valley Police Department
Quartzsite Marshal's Office
Safford Police Department
St. Johns Police Department
San Luis Police Department
Santa Cruz County Sheriff's Office
Scottsdale Police Department
Sedona Police Department
Show Low Police Department
Sierra Vista Police Department
Snowflake-Taylor Police Department
Somerton Police Department
South Tucson Police Department
Springerville Police Department
State Capitol Police Department
Superior Police Department
Surprise Police Department
Tempe Police Department
Thatcher Police Department
Tolleson Police Department
Tombstone Marshal's Office
Tucson Police Department
University of AZ Police Department
Wellton Marshal's Office
Wickenburg Police Department
Willcox Police Department
Winslow Police Department
Yavapai College Police Department
Yavapai County Sheriff's Office
Youngtown Police Department
Yuma County Sheriff's Office
Yuma Police Department

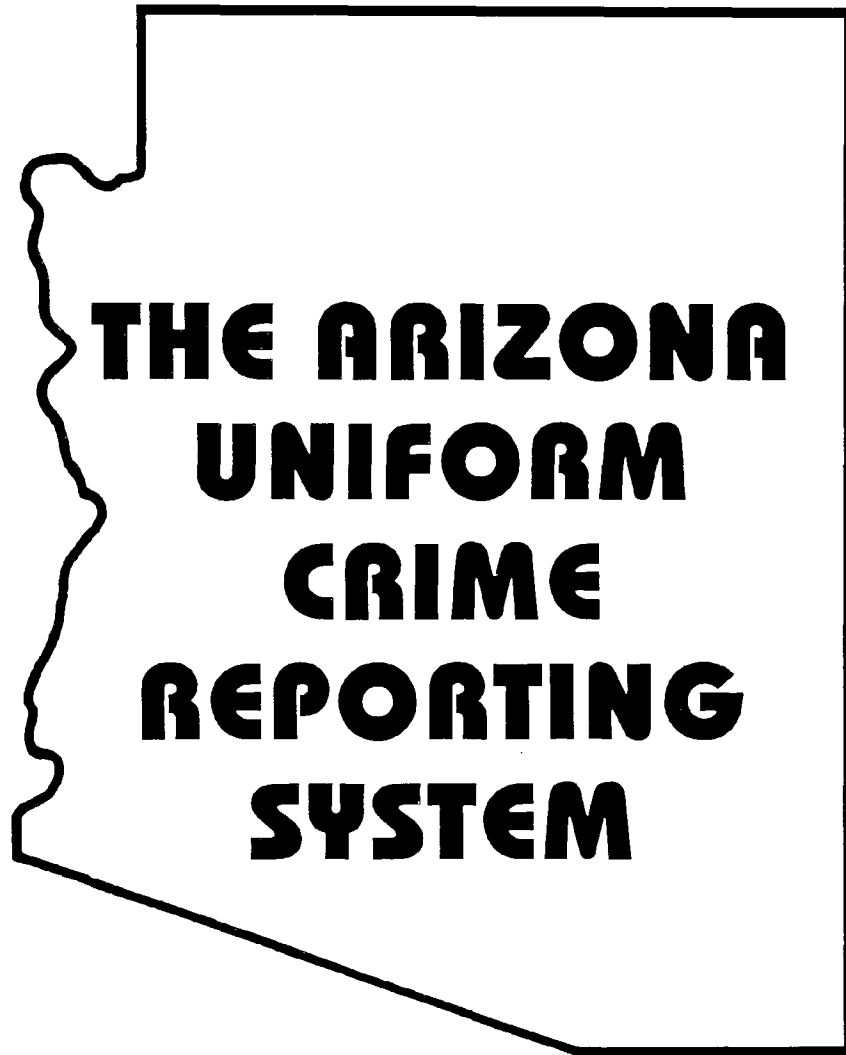

**THE ARIZONA
UNIFORM
CRIME
REPORTING
SYSTEM**

HISTORY OF UNIFORM CRIME REPORTING

The Committee on Uniform Crime Records of the International Association of Chiefs of Police (IACP) was established in 1927 to initiate a national program for collecting crime information. This Committee's responsibility to provide management information to law enforcement agencies was eventually turned over to the Federal Bureau of Investigation (FBI) in 1930, when the FBI received a Congressional mandate to collect and disseminate national crime information. The IACP has continued to serve the Uniform Crime Reporting (UCR) Program in an advisory capacity and was joined in this responsibility by the Committee on Crime Records of the National Sheriff's Association (NSA) in 1966.

The Arizona Uniform Crime Reporting (AUCR) Section first began receiving voluntary crime information from Arizona law enforcement agencies in January 1975. Prior to this date these agencies submitted their crime data directly to the FBI.

OBJECTIVES OF ARIZONA UCR

Due to increased attention being focused on the problem of crime in our communities in recent years, many segments of our population need more complete information for a variety of reasons.

Law enforcement professionals, managers and administrators who must focus on crime in their own jurisdictions, also need to know what is occurring in surrounding jurisdictions in order to deploy personnel and equipment more efficiently. Researchers and planners need to know what is actually happening to predict trends and recommend changes.

The goal of the *Crime in Arizona* is to identify the nature and extent of criminal activity in this state and present the information needed by each of these groups. This information will not in itself prevent crime, but it may encourage all segments of society, by understanding the problem, to work together with law enforcement agencies to reduce crime through more effective enforcement.

The objectives of the *Crime in Arizona* are: (1) To identify the nature and extent of crime in our state; (2) To provide the management information needed by the law enforcement community to augment their ability to attack the crime problem; (3) To provide our citizens with the most complete information available; (4) To provide legislators with the information necessary to formulate laws which address the crime problem, and (5) To provide sufficient detailed data for researchers and planners.

CONSIDERATIONS FOR INTERPRETATION

Statistics are tools used to summarize information so that patterns or trends become clearer. All statistics must be interpreted with an understanding of just what it is that they can say. Too often information of the type in this report is used incorrectly to draw conclusions that the statistics simply do not support. We ask that great care be taken in analysis and interpretation.

The following factors have a major influence on the statistics presented in this report:

1. Crime figures are police statistics as distinguished from the findings of a court, coroner, jury or decision of a prosecutor.
2. Density and size of community population.
3. Variations in composition of the population, particularly age structure.
4. Stability of population with respect to transient factors.
5. Economic conditions, including job availability.
6. Climate.
7. Effective strength of law enforcement agencies; some police jurisdictions overlap.
8. Attitudes of citizenry toward crime.
9. Crime reporting practices of citizenry.
10. Crime rates are based on census-fixed residential populations of police jurisdictions.
11. Crimes committed on Indian reservations are not reported to the AUCR program, although their population is included in the state's population figures.
12. Incomplete or zero data from reporting agencies or non-participation of some local law enforcement agencies. The number of these agencies will vary from year to year.

To obtain accurate information from many different agencies, the national UCR program had to precisely define the methods for collecting such information as the number of offenses, arrests, clearances and value of stolen or recovered property.

Classification of Offenses

UCR divides offenses into two major classifications which are designated Part I and Part II offenses. This distinction is important to keep in mind because different information is collected for each.

Part I offenses include:

Violent Crimes

- Criminal Homicide
- Forcible Rape
- Robbery
- Aggravated Assault

Property Crimes

- Burglary
- Larceny-Theft
- Motor Vehicle Theft
- Arson

Part II offenses include:

- Other Assaults-simple
- Forgery and Counterfeiting
- Fraud
- Embezzlement
- Stolen Property; Buying, Receiving, Possessing, etc.
- Vandalism
- Weapons; Carrying, Possessing, etc.
- Prostitution
- Sex Offenses (except forcible rape and prostitution)
- Narcotic Drug Laws
- Gambling
- Offenses Against Family and Children
- Driving Under the Influence
- Liquor Laws
- Drunkenness (not reported in Arizona)
- Disorderly Conduct
- Vagrancy
- All Other Offenses (except traffic)
- Suspicion (not reported in Arizona)
- Curfew and Loitering Law Violations (Juveniles)
- Runaways (Juveniles)

Note: Only arrests are counted for Part II offenses.

All offenses are classified on the basis of law enforcement officer investigation in accordance with UCR offense definitions (which will not necessarily be identical to Criminal Code definitions). Because UCR identifies a police problem, offense classifications are not based on the findings of a court, coroner, jury or decisions of a prosecutor.

Counting of Offenses

The number of offenses is collected only for Part I crimes and simple assault. The method of counting offenses varies with the type of crime committed, and it is important to remember that the number of offenders does not determine the number of offenses.

For murder and nonnegligent manslaughter, negligent manslaughter, rape, aggravated assault and simple assault, one offense is counted for each victim, regardless of the number of offenders involved.

For robbery and larceny-theft, one offense is counted for each distinct operation which is separate in time and place. The number of victims in any one operation does not determine the number of offenses.

For burglary, one offense is counted for each structure which is illegally entered. However, when the structure is an apartment house, business or office building in which units are leased for a period of time, one offense is counted for each unit burglarized.

For motor vehicle theft, one offense is counted for each vehicle stolen.

Note: Attempts to commit any one of the above are also counted as offenses, except that attempts to kill and assaults to kill are counted as aggravated assaults.

For multiple offenses that occur in one crime incident, only the most serious offense is counted. In cases when an arson occurs in conjunction with other Part I crimes, both are reported. Part I offenses are ranked according to seriousness and appear in order from most serious to least serious under "Classifications of Offenses."

Clearances

An offense is considered cleared (solved) when at least one offender is arrested for a crime, even though several may have been involved.

Offenses may also be cleared by exceptional means when the offender: commits suicide; makes a dying declaration; confesses while in custody or serving time for another crime; is prosecuted in another jurisdiction for the same offense; is a juvenile who is handled by notifying the parents; when the victim refuses to prosecute or another jurisdiction refuses to extradite the offender.

Clearances are counted as "adult" and "juvenile". A "juvenile" clearance is counted only when juveniles are *exclusively* involved in the clearance of an offense. If the arrest of both adults and juveniles

results in a clearance, it is counted as an "adult" clearance.

Property Stolen and Recovered

The figures for value of property stolen and recovered report the value at each point in time. Although property can increase in value over time, it is more likely that stolen property will be recovered in a damaged condition. Therefore, recovery value does not necessarily represent a "clearance rate" for stolen property, and one cannot use it to determine law enforcement effectiveness in recovering stolen goods. Because stolen and recovered property figures indicate thefts and recoveries in the current year, it is important to note that recovered property may have been stolen in a previous year. In addition, the type and value of stolen or recovered property is reported only for Part I offenses and does not include such Part II offenses as fraud, forgery or embezzlement.

Arrests

Arrest information is collected for all Part I and Part II offenses according to the age, sex and race of the offender. It is not possible, however, to correlate race with sex or specific ages because the information is collected independently, thus limiting analysis. Furthermore, arrest figures cannot be directly related to the number of crimes cleared because arrest totals count all offenders arrested for each offense, and clearance totals count only the offenses for which an arrest(s) or exceptional clearance(s) has occurred.

Reporting Variations and Procedures

One must be aware that unintentional variations from UCR guidelines may occur that would affect the validity of the data presented in this report. Offense totals vary from the actual number of offenses that occur because UCR statistics are based on crimes that are reported to law enforcement agencies and many crimes are not reported.

Each contributing law enforcement agency is responsible for compiling its own monthly reports. An FBI UCR handbook is supplied to all contributors outlining reporting procedures in detail and is also complete with examples and illustrations.

POPULATION GROUPING

The crime statistics reported by an individual agency indicates what is happening in one particular area. AU CR groups jurisdictions on the basis of population size and reports crime rates among these groups. The cities, towns and counties within the state have

been divided into seven groups according to population size. The seventh group (ungrouped) is provided for identification of volume and type of crime to account for total offenses. This population grouping factor has some influence on the volume and type of crime presented in this report. For use in interpreting this report, the UCR grouping is listed below:

Group No

1. Over 250,000 population. There are four (4) cities that fall within this group.
2. 100,001 to 250,000 population. There are four (4) cities and counties that fall within this group.
3. 50,001 to 100,000 population. There are seven (7) cities and counties that fall within this group.
4. 25,001 to 50,000 population. There are nine (9) cities and counties that fall within this group.
5. 10,001 to 25,000 population. There are fourteen (14) cities and counties that fall within this group.
6. 10,000 or less population. There are forty-six (46) cities and counties that fall within this group.
7. Ungrouped. There are ten (10) reporting agencies. These are educational institutions, the State Capitol Police and the Department of Public Safety, that by definition do not have measurable population. For purposes of this report, they are combined for the crimes by population distribution.

The following is a listing by population group of law enforcement agencies submitting crime data to the Uniform Crime Reporting Section.

AGENCY	POPULATION GROUP NO.	AGENCY	POPULATION GROUP NO.
Apache County S.O.	3	Mohave County S.O.	4
Apache Junction P.D.	5	Navajo County S.O.	3
Arizona DPS	7	Nogales P.D.	5
ASU DPS	7	Northern AZ Univ. P.D.	7
ASU West P.D.	7	Oro Valley P.D.	5
AZ Western College P.D.	7	Paradise Valley P.D.	5
Avondale P.D.	5	Parker P.D.	6
Benson P.D.	6	Payson P.D.	6
Bisbee P.D.	6	Peoria P.D.	3
Buckeye P.D.	6	Phoenix P.D.	1
Bullhead City P.D.	4	Pima College P.D.	7
Camp Verde M.O.	6	Pima County S.O.	1
Casa Grande P.D.	5	Pima P.D.	6
Central AZ College P.D.	7	Pinal County S.O.	3
Chandler P.D.	3	Pinetop-Lakeside P.D.	6
Chino Valley P.D.	6	Prescott P.D.	4
Clarkdale P.D.	6	Prescott Valley P.D.	5
Cochise County S.O.	4	Quartzsite M.O.	6
Coconino County S.O.	4	Safford P.D.	6
Coolidge P.D.	6	St. Johns P.D.	6
Cottonwood P.D.	6	San Luis P.D.	6
Douglas P.D.	5	Santa Cruz County S.O.	5
Eagar P.D.	6	Scottsdale P.D.	2
El Mirage P.D.	6	Sedona P.D.	6
Eloy P.D.	6	Show Low P.D.	6
Flagstaff P.D.	3	Sierra Vista P.D.	4
Florence P.D.	6	Snowflake-Taylor P.D.	6
Gila County S.O.	5	Somerton P.D.	6
Gilbert P.D.	4	South Tucson P.D.	6
Glendale P.D.	2	Springerville P.D.	6
Globe P.D.	6	State Capitol P.D.	7
Goodyear P.D.	6	Superior P.D.	6
Graham County S.O.	5	Surprise P.D.	6
Greenlee County S.O.	6	Tempe P.D.	2
Hayden P.D.	6	Thatcher P.D.	6
Holbrook P.D.	6	Tolleson P.D.	6
Huachuca City P.D.	6	Tombstone M.O.	6
Jerome P.D.	6	Tucson P.D.	1
Kearny P.D.	6	U of A P.D.	7
Kingman P.D.	5	Wellton M.O.	6
Lake Havasu City P.D.	4	Wickenburg P.D.	6
La Paz County S.O.	5	Willcox P.D.	6
Mammoth P.D.	6	Winslow P.D.	5
Marana P.D.	6	Yavapai College P.D.	7
Maricopa County S.O.	2	Yavapai County S.O.	3
Mesa P.D.	1	Youngtown P.D.	6
Miami P.D.	6	Yuma County S.O.	4

Note: Estimated population figures for these groups are furnished by the Population Statistics Unit, Arizona Department of Economic Security. The 1994 population for Arizona was estimated to be 4,071,650.



**SUMMARY
OF STATE
CRIME DATA**

ARIZONA CRIME CLOCK 1994

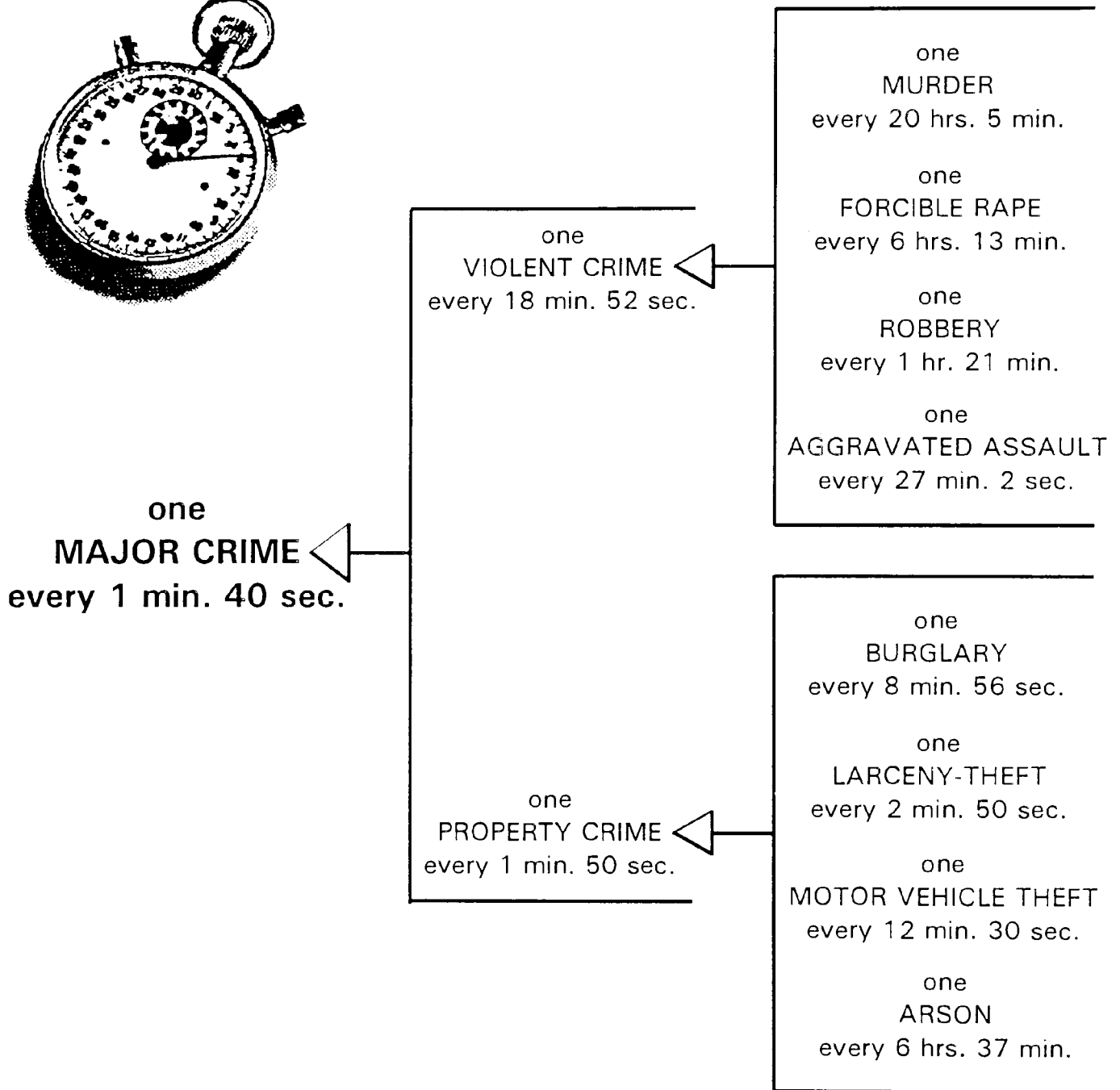
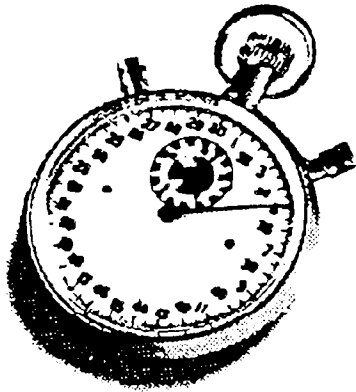

The crime clock should be viewed with care. Being the most aggregate representation of UCR data, it is designed to convey the annual reported crime experience by showing the relative frequency of occurrence of the Offenses. This mode of display should not be taken to imply a regularity in the commission of the Offenses; rather, it represents the annual ratio of crime to affixed time intervals.

ARIZONA CRIME CYCLE

The following represents the approximate number of Crime Index Offenses that were reported to Arizona law enforcement agencies every 24 hours during 1994.

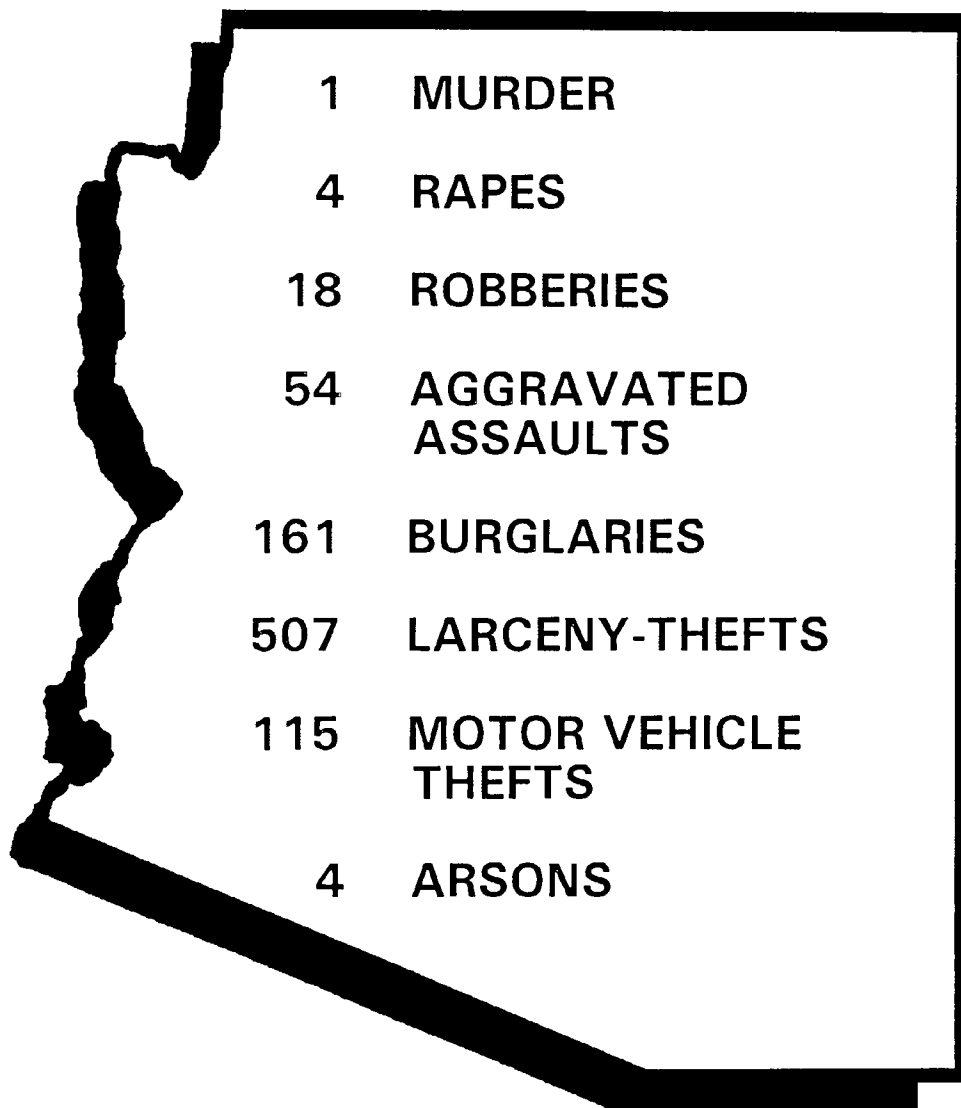

STATE CRIME SUMMARY

CRIME INDEX OFFENSES

- There were 314,931 Crime Index Offenses reported in 1994.
- October recorded the highest incidence of offenses with 26,673 reported while February recorded the lowest incidence of offenses with 23,571 reported.
- The value of property stolen amounted to \$354,547,669 in 1994.
- The value of property recovered amounted to \$139,093,890 for a recovery rate of 39.2 percent.
- The crime rate for 1994 for Arizona was 7,734.1 crimes per 100,000 population.

CRIME INDEX ARRESTS/CLEARANCES

- During 1994, a total of 56,222 persons were arrested for Index offenses.
- Adult Index arrests were 37,787 and juvenile arrests were 18,435.
- Males accounted for 76.4 percent of the Index arrests and females accounted for 23.6 percent.
- A total of 57,680 clearances, representing 18.3 percent, of Index Offenses was reported in 1994. Juveniles represented 22.8 percent of this total.

VIOLENT CRIME

OFFENSES

- A total of 28,011 violent crimes were reported in 1994.
- Violent crimes accounted for 8.9 percent of the total Crime Index.
- The highest number of violent crimes was reported in September with 2,705 offenses while the lowest number was reported in January with 2,113 offenses.
- Aggravated assault accounted for the largest incidence of violent crimes with 19,704 offenses while homicide accounted for the smallest with 419 offenses.
- The value of property stolen was \$5,574,969.
- The crime rate was 687.9 offenses per 100,000 population.

ARRESTS/CLEARANCES

- There were 9,602 arrests for violent crimes in 1994.
- Adult arrests were 7,330 and juvenile arrests were 2,272.
- Males accounted for 86.9 percent and females accounted for 13.1 percent.
- A total of 11,736 clearances, representing 41.9 percent, of violent crimes was reported in 1994. Juveniles represented 17.2 percent of this total.

PROPERTY CRIME

OFFENSES

- A total of 286,920 property crimes were reported in 1994.
- Property crimes accounted for 91.1 percent of the total Crime Index.
- The highest number of property crimes was reported in October with 24,257 offenses while the lowest number was reported in February with 21,353 offenses.
- Larceny-theft accounted for the largest incidence of property crimes with 185,037 offenses while arson accounted for the smallest with 1,325 offenses.
- The value of property stolen was \$348,972,700.
- The crime rate was 7,046.2 offenses per 100,000 population.

ARRESTS/CLEARANCES

- There were 46,620 arrests for property crimes in 1994.
- Adult arrests were 30,457 and juvenile arrests were 16,163.
- Males accounted for 74.2 percent and females accounted for 25.8 percent.
- A total of 45,944 clearances, representing 16.0 percent, of property crimes was reported in 1994. Juveniles represented 24.2 percent of this total.

TOTAL ARRESTS

- There were 271,986 persons arrested in 1994.
- Adult arrests were 207,339 and juvenile arrests were 64,647.
- Males accounted for 78.9 percent and females accounted for 21.1 percent.
- Part I offenses accounted for 56,222 arrests.
- Part II offenses accounted for 215,764 arrests.

The following agencies provided zero (0) data for 1994: Clifton P.D. (Greenlee Co.), Douglas P.D. (Cochise Co.), Duncan P.D. (Greenlee Co.), Eloy P.D. (Pinal Co.), Fredonia M.O. (Coconino Co.), Oro Valley P.D. (Pima Co.), Page P.D. (Coconino Co.), Patagonia M.O. (Santa Cruz Co.), Williams P.D. (Coconino Co.), and Yuma P.D. (Yuma Co.).

The following agencies provided only partial data for 1994: Clarkdale P.D. (Yavapai Co.), Jerome P.D. (Yavapai Co.), NAU P.D. (Coconino Co.), Parker P.D. (La Paz Co.), Pima P.D. (Graham Co.), and Yuma County S.O.

TOTAL INDEX CRIMES BY MONTH

INDEX CRIMES	TOTALS	JAN	FEB	MAR	APR	MAY	JUN	JUL	AUG	SEPT	OCT	NOV	DEC*
Murder	419	27	28	32	33	21	27	41	39	41	43	29	58
Forcible Rape	1,409	131	110	115	104	95	131	126	148	132	128	103	86
Robbery	6,479	530	527	543	563	490	489	496	538	589	590	569	555
Aggravated Assault	19,704	1,425	1,553	1,715	1,572	1,728	1,628	1,714	1,863	1,943	1,655	1,470	1,438
Burglary	58,638	4,576	4,155	4,774	4,840	4,757	4,574	5,289	5,523	5,203	4,977	4,839	5,131
Larceny-Theft	185,037	14,974	14,273	14,310	13,560	13,678	13,877	13,768	14,109	13,798	15,020	14,386	29,284
Motor Vehicle Theft	41,920	3,058	2,825	3,384	2,954	3,172	3,524	3,682	3,525	3,720	4,141	3,753	4,182
Arson	1,325	113	100	107	112	96	130	131	117	104	119	90	106
TOTALS	314,931	24,834	23,571	24,980	23,738	24,037	24,380	25,247	25,862	25,530	26,673	25,239	40,840

* One agency determined they had under reported their larceny-thefts for 1994. The additional offenses were included in the December figures, since the agency was unable to provide a monthly breakdown.

INDEX CRIMES CLEARED*

(Percent of Total)

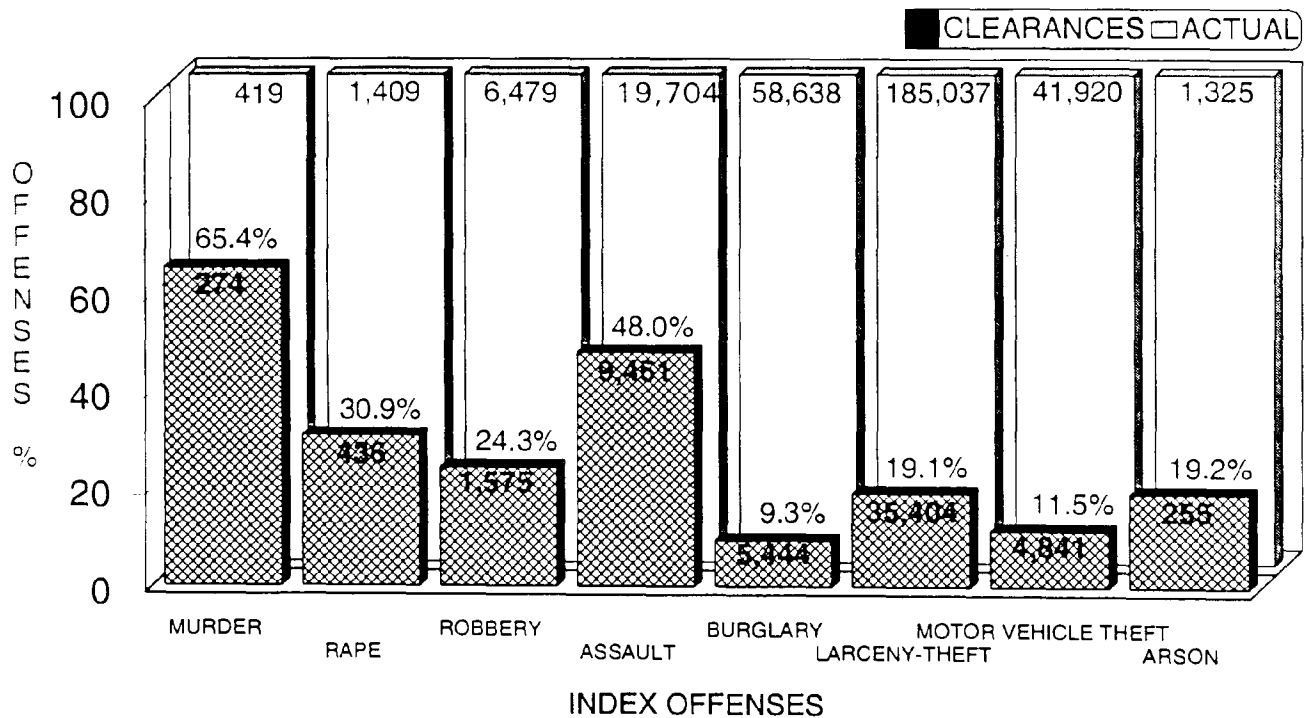

*Clearances may include offenses which were reported in prior years.

INDEX CRIME COMPARISON*

INDEX OFFENSES		Number of Offenses	Number of Offenses Cleared	Percent of Offenses Cleared
MURDER	1993	323	234	72.45
	1994	414	269	64.98
	Percent Change	+28.17	+14.96	-10.31
RAPE	1993	1,431	469	32.77
	1994	1,388	427	30.76
	Percent Change	-3.00	-8.96	-6.13
ROBBERY	1993	6,274	1,642	26.17
	1994	6,464	1,573	24.33
	Percent Change	+3.03	-4.20	-7.03
AGGRAVATED ASSAULT	1993	19,088	9,547	50.02
	1994	19,510	9,306	47.70
	Percent Change	+2.21	-2.52	-4.64
BURGLARY	1993	54,973	5,305	9.65
	1994	57,464	5,234	9.11
	Percent Change	+4.53	-1.34	-5.60
LARCENY-THEFT	1993	164,900	33,528	20.33
	1994	183,416	35,080	19.13
	Percent Change	+11.23	+4.63	-5.90
MOTOR VEHICLE THEFT	1993	33,056	3,784	11.45
	1994	41,690	4,750	11.39
	Percent Change	+26.12	+25.53	-0.52
ARSON	1993	1,143	266	23.27
	1994	1,272	238	18.71
	Percent Change	+11.29	-10.53	-19.60
TOTAL INDEX CRIME	1993	281,188	54,775	19.48
	1994	311,618	56,877	18.25
	Percent Change	+10.82	+3.84	-6.31

*For the purposes of this comparison chart only, statistics from ten agencies have been excluded. These agencies were unable to provide complete reports for a full twelve month period in 1993 and/or 1994. These agencies are: Clarkdale P.D., Douglas P.D., Eloy P.D., Hayden P.D., Jerome P.D., Mohave County S.O., NAU P.D., Parker P.D., Pima P.D. and Yuma County S.O.

(Figures for 1993 may have been updated and therefore may vary from previously published statistics.)

VALUE OF PROPERTY LOSS BY INDEX CRIME OFFENSE-STATE TOTALS

The table below reflects the amount of property stolen by offense category. Motor vehicle theft accounted for the highest property loss, \$188,468,919 or 53 percent of the total. The next highest category was burglary with \$86,439,766 or 24 percent of the total.

OFFENSE	Number of Offenses	Dist.	(\$)Value of Property Stolen	Dist.	Average (\$)Value
Murder	419	0.14%	25,267	0.01%	60.30
Rape	1,409	0.48%	63,809	0.02%	45.29
Robbery	6,479	2.21%	5,485,893	1.54%	846.72
Burglary	58,638	19.95%	86,439,766	24.38%	1,474.13
Larceny-Theft	185,037	62.96%	74,064,015	20.89%	400.27
Motor Vehicle Theft *	41,920	14.26%	188,468,919	53.16%	4,495.92
TOTAL	293,902	100.00%	\$354,547,669	100.00%	\$1,206.35

*Motor vehicles that were stolen in conjunction with a more "serious" index offense such as robbery or burglary are not included in this count. This count represents only those instances in which motor vehicle theft was the only or most "serious" offense committed. The total value shown here reflects the value of all property stolen during the commission of the offense (i.e., not just the value of each vehicle).

TYPE AND VALUE OF PROPERTY STOLEN AND RECOVERED-STATE TOTALS

The table below reflects the amount of property stolen and recovered by property type. Locally stolen motor vehicles accounted for the highest property loss in a single category with \$188,058,742. Locally stolen motor vehicles were also the most easily recovered property with a recovery rate of 68 percent or \$127,036,863.

TYPE OF PROPERTY	(\$)Value Stolen	Dist.	(\$)Value Recovered	Percent Recovered
Currency and Notes	10,936,635	3.09%	645,217	5.90%
Jewelry and Precious Metals	29,345,239	8.28%	1,114,345	3.80%
Clothing and Furs	5,039,066	1.42%	925,550	18.37%
Locally Stolen Motor Vehicles	188,058,742	53.04%	127,036,863	67.55%
Office Equipment	11,624,034	3.28%	495,948	4.27%
TVs, Radios, Cameras, etc.	34,984,227	9.87%	1,094,050	3.13%
Firearms	4,389,470	1.24%	429,805	9.79%
Household Goods	7,421,145	2.09%	319,592	4.31%
Consumable Goods	1,294,220	0.36%	260,281	20.11%
Livestock	138,566	0.04%	12,137	8.76%
Miscellaneous	61,316,325	17.29%	6,760,102	11.02%
TOTAL	\$354,547,669	100.00%	\$139,093,890	39.23%

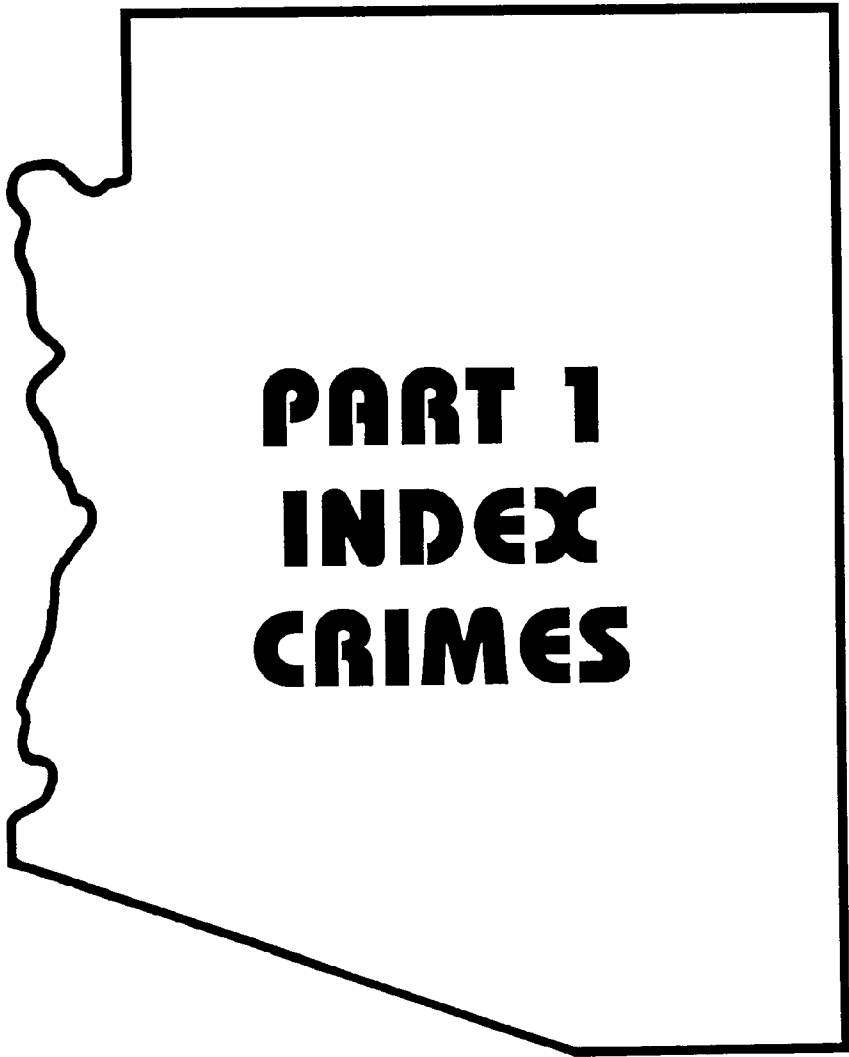

**PART 1
INDEX
CRIMES**

VIOLENT CRIMES

- Murder
- Rape
- Robbery
- Aggravated Assault

PROPERTY CRIMES

- Burglary
- Larceny-Theft
- Motor Vehicle Theft
- Arson

MURDER AND NONNEGLIGENT MANSLAUGHTER

DEFINITION

The willful (nonnegligent) killing of one person by another. Attempted murders and assaults to murder are classified as aggravated assaults. Suicides, traffic fatalities, accidental deaths, negligent manslaughters, and justifiable homicides are not counted under this classification.

SUMMARY

- There were 419 murders reported during 1994.
- Murder accounted for 0.1 percent of the total Index offenses and 1.5 percent of the total violent crimes.
- December recorded the highest number, with 58, while May recorded the lowest with 21.
- Sunday reported the highest incidence of murders, with 78, while Tuesday was the lowest with 44.
- The time period of 6:01 PM - 2:00 AM recorded the highest number of murders, with 189, while 10:01 AM - 6:00 PM was the lowest with 99.
- Firearms were used in 72.8 percent of the murders.
- In murders where the relationship between the victim and offender was known, 17.4 percent were acquaintances.

ARRESTS/CLEARANCES

- A total of 329 persons were arrested in 1994.
- Adults accounted for 260 arrests and juveniles accounted for 69 arrests.
- Males accounted for 88.1 percent and females accounted for 11.9 percent.
- There were a total of 274 clearances for murder reported in 1994. Juveniles represented 10.9 percent of this total.

MURDER BY POPULATION GROUP

	1	2	3	4	5	6	7
Population Group	Over 250,000	100,001 To 250,000	50,001 To 100,000	25,001 To 50,000	10,001 To 25,000	10,000 Or Less	Ungrouped
Murder	297	35	28	31	16	12	---
Distribution	70.9%	8.3%	6.7%	7.4%	3.8%	2.9%	---

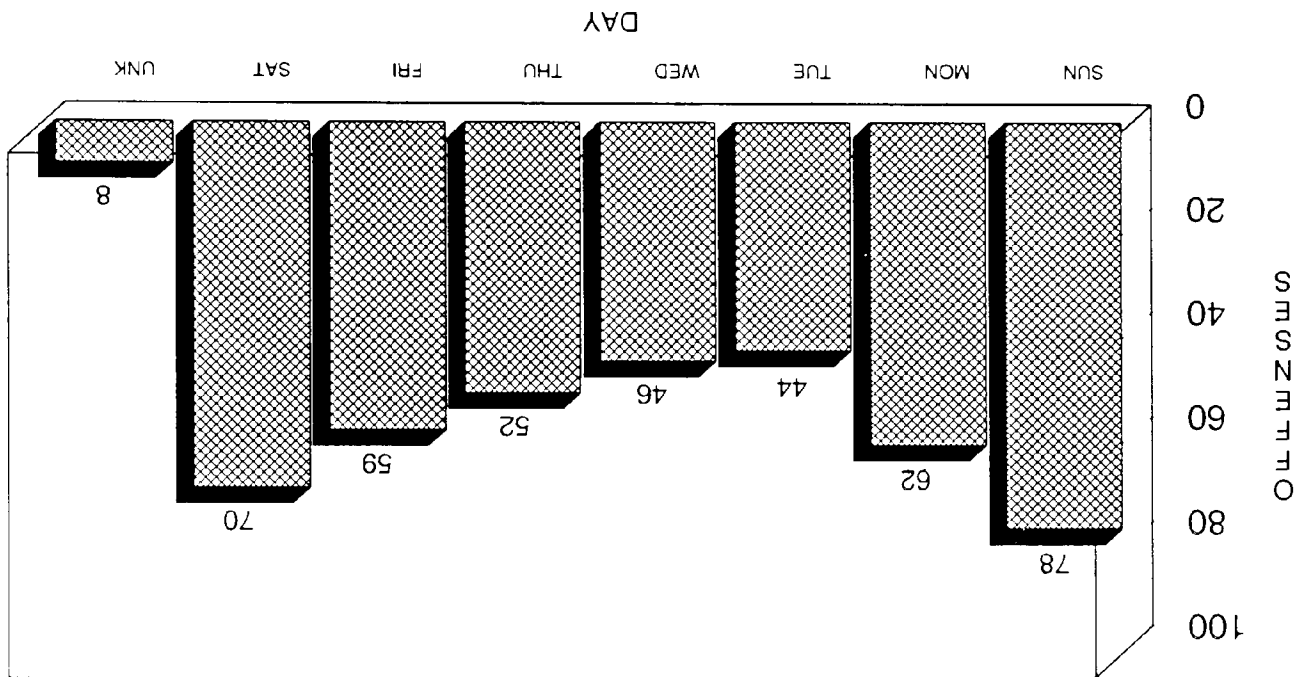

MURDER BY DAY OF WEEK

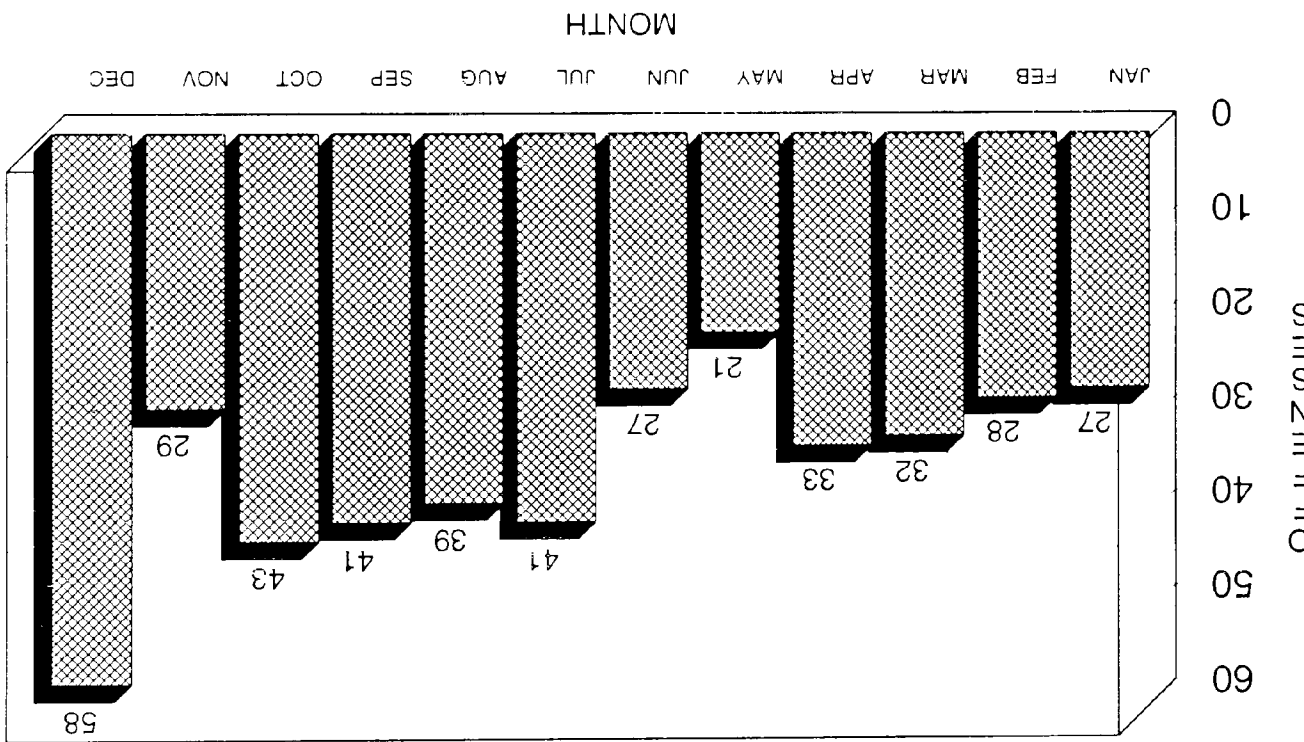

MURDER BY MONTH

MURDER BY TIME OF DAY

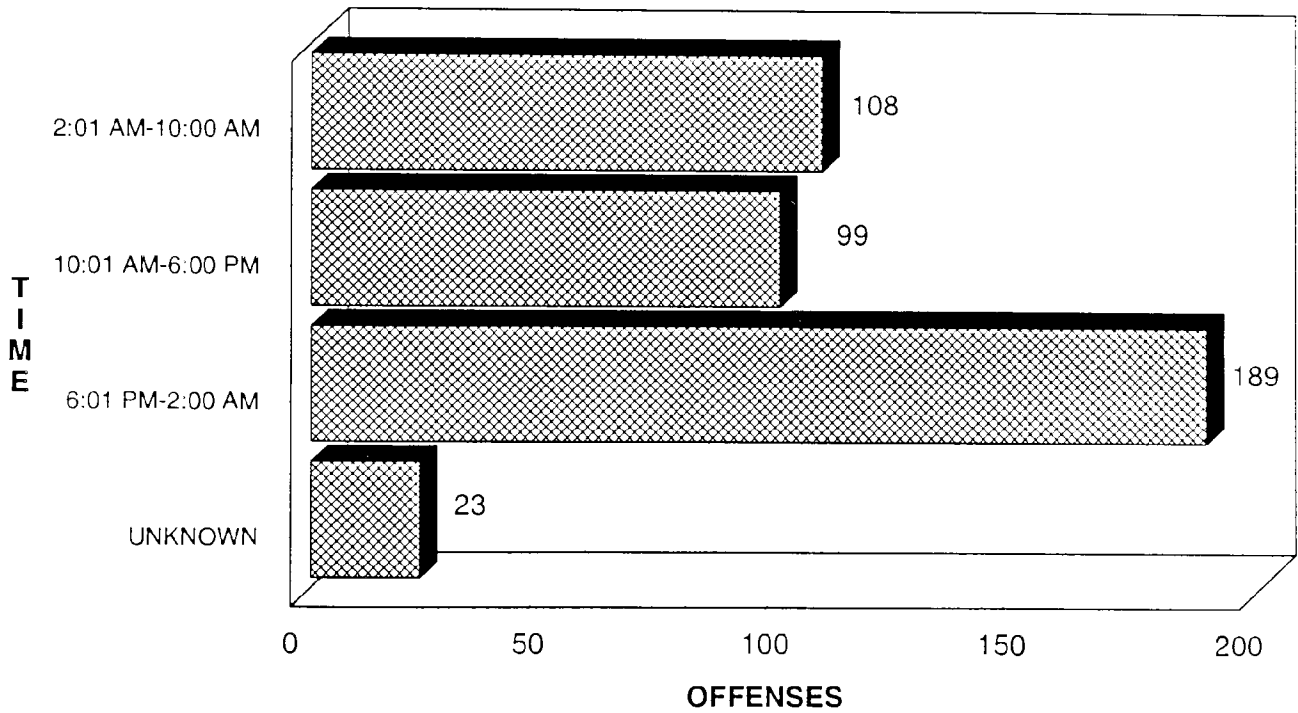

MURDER DISTRIBUTION BY CIRCUMSTANCE

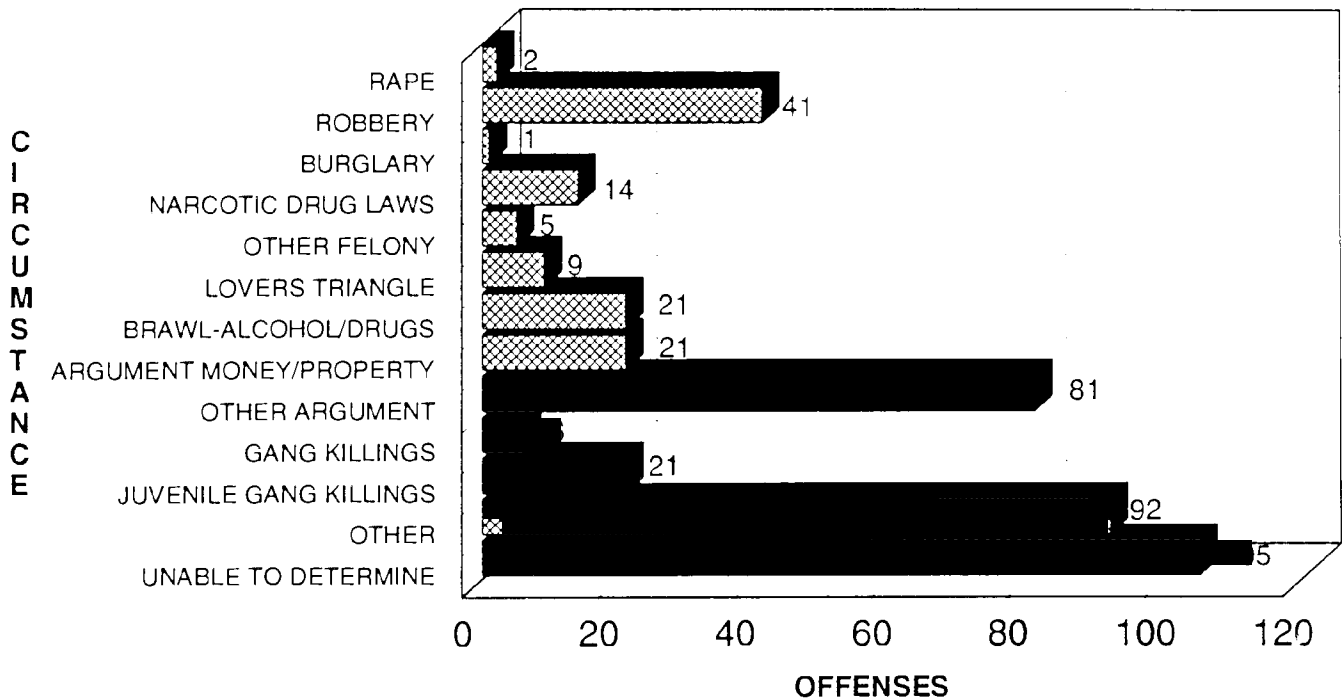

MURDER BY TYPE OF WEAPON USED

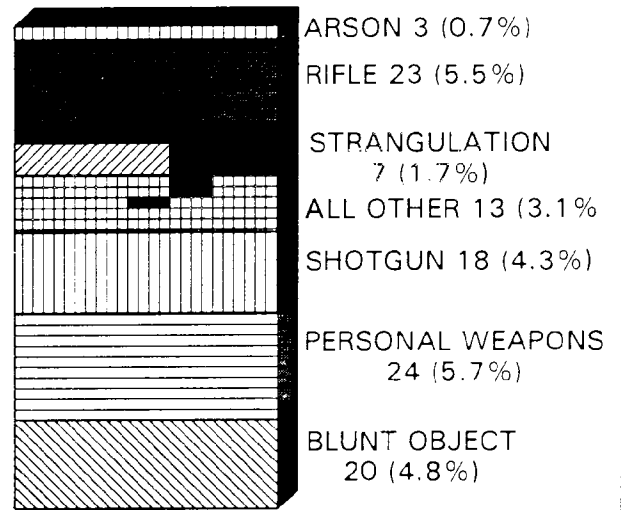
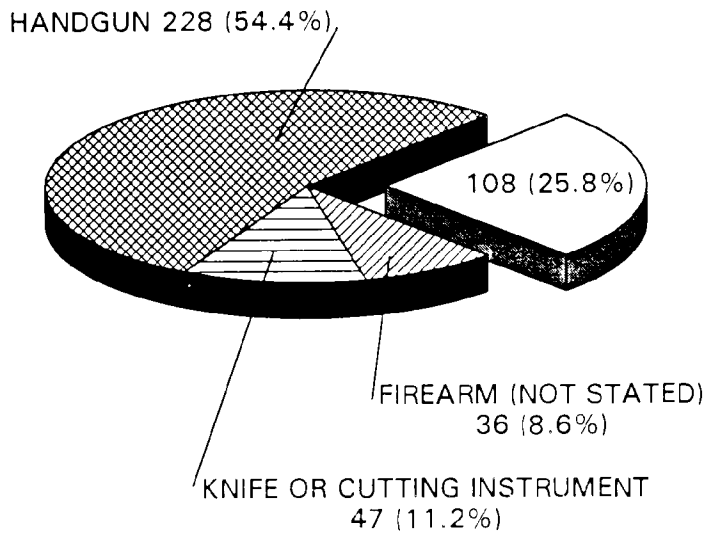

MURDER DISTRIBUTION BY RELATIONSHIP

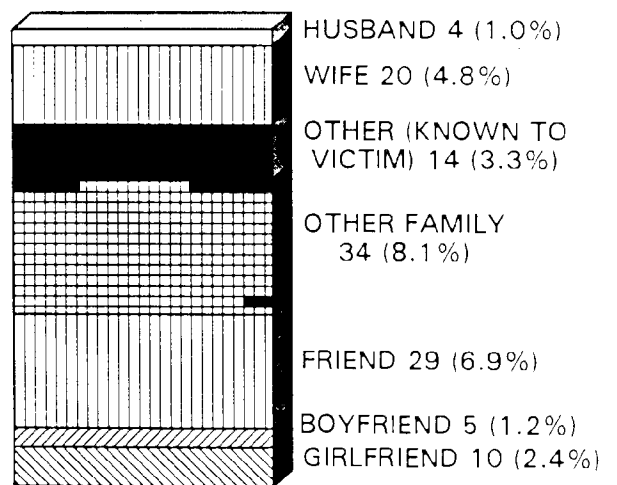
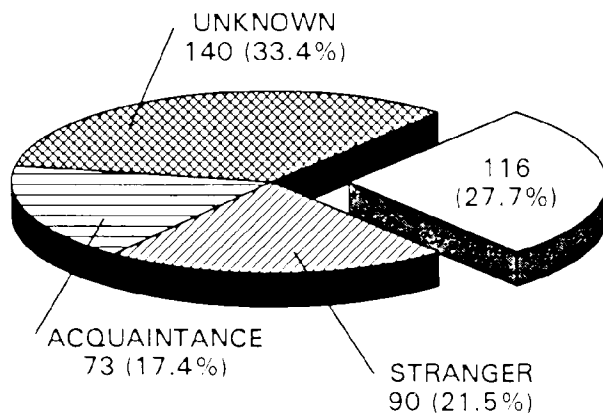

MURDER VICTIM BY AGE, SEX, RACE & ETHNIC ORIGIN

AGE	NUMBER	DISTRIBUTION	SEX		RACE				ETHNIC ORIGIN	
			MALE	FEMALE	WHITE	BLACK	INDIAN	ASIAN	HISPANIC	NOT HISPANIC
Infant	7	1.7%	4	3	3	3	1	---	---	7
1-4	14	3.3%	4	10	9	4	1	---	2	12
5-9	3	0.7%	1	2	2	1	---	---	1	2
10-14	3	0.7%	2	1	3	---	---	---	2	1
15-19	63	15.1%	55	8	49	13	1	---	32	31
20-24	72	17.2%	63	9	57	12	3	---	40	32
25-29	57	13.6%	54	3	44	10	2	1	32	25
30-34	55	13.1%	38	17	45	6	4	---	16	39
35-39	41	9.8%	32	9	35	6	---	---	12	29
40-44	25	6.0%	22	3	21	4	---	---	5	20
45-49	21	5.0%	16	5	19	1	1	---	4	17
50-54	11	2.6%	7	4	9	1	1	---	4	7
55-59	10	2.4%	10	---	9	1	---	---	2	8
60-64	11	2.6%	9	2	10	---	1	---	4	7
65-69	4	1.0%	3	1	3	1	---	---	---	4
70-74	9	2.1%	7	2	7	2	---	---	---	9
75 and Over	9	2.1%	3	6	6	3	---	---	---	9
Unknown	4	1.0%	4	---	3	1	---	---	1	3
TOTAL	419	---	334	85	334	69	15	1	157	262
Distribution	---	100.0%	79.7%	20.3%	79.7%	16.5%	3.6%	0.2%	37.5%	62.5%
ADULT	360	85.9%								
JUVENILE	55	13.1%								
UNKNOWN	4	1.0%								

RAPE

DEFINITION

The carnal knowledge of a female through the use of force or threat of force. Assaults or attempts to commit forcible rape are also included; however, statutory rape (without force) and other sex offenses are not counted in this category.

SUMMARY

- There were 1,409 rapes reported during 1994.
- Rape accounted for 0.4 percent of the total Index offenses and 5.0 percent of violent crimes.
- August recorded the highest number, with 148, while December recorded the lowest with 86.
- Of the total rapes, forcible accounted for 1,118 and attempted accounted for 291.



ARRESTS/CLEARANCES

- A total of 246 persons were arrested in 1994.
- Adults accounted for 212 arrests and juveniles accounted for 34 arrests.
- There were a total of 436 clearances for rape reported in 1994. Juveniles represented 8.7 of this total.

RAPE BY POPULATION GROUP

	1	2	3	4	5	6	7
Population Group	Over 250,000	100,001 To 250,000	50,001 To 100,000	25,001 To 50,000	10,001 To 25,000	10,000 Or Less	Ungrouped
Rape by Force	728	131	89	75	41	43	11
Attempted Rape	213	28	13	13	11	8	5
TOTAL	941	159	102	88	52	51	16
Distribution	66.8%	11.3%	7.2%	6.3%	3.7%	3.6%	1.1%

RAPE BY MONTH (Total Offenses)

 ATTEMPTED FORCIBLE RAPE
 ACTUAL RAPE

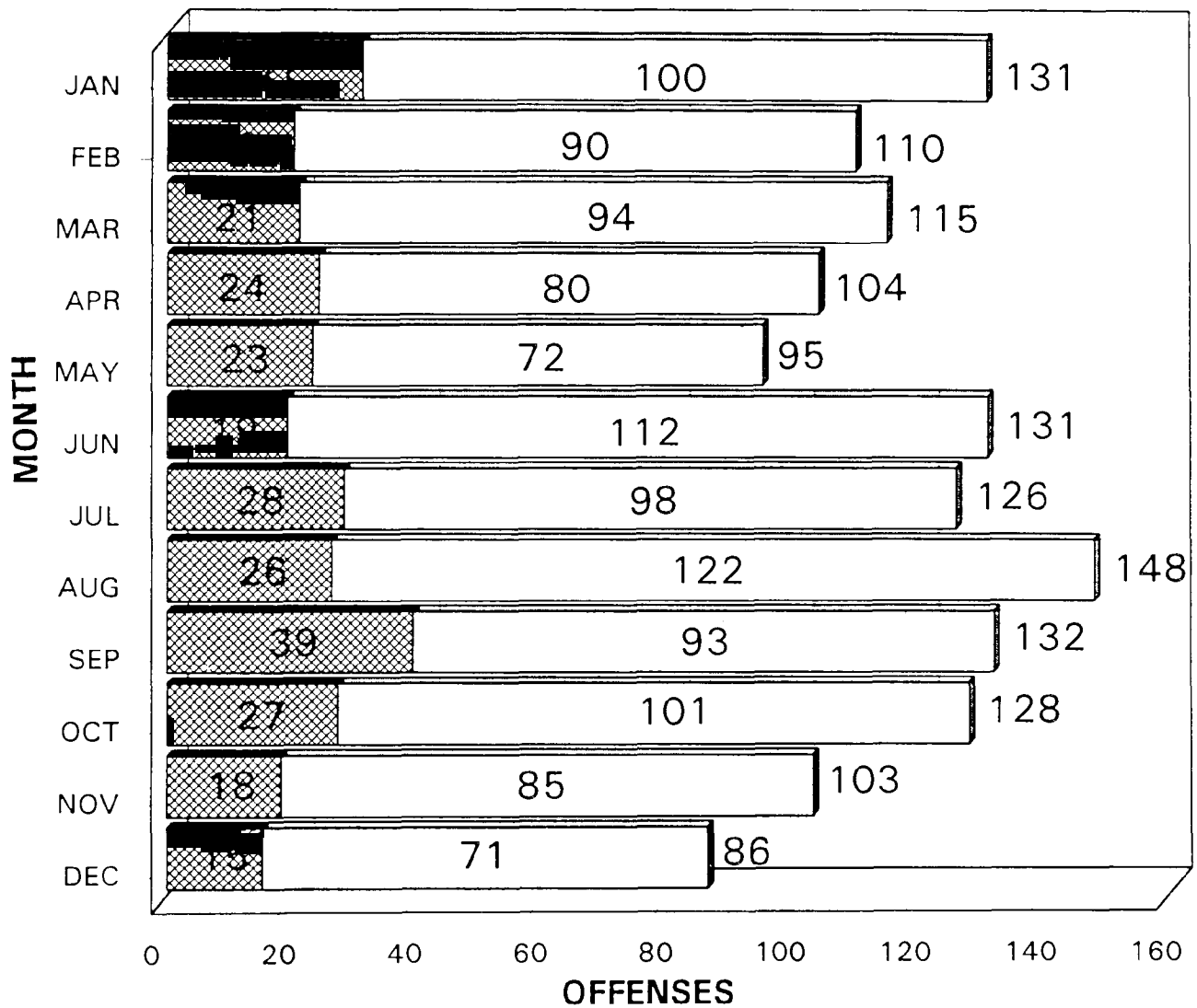

ROBBERY

DEFINITION

The taking or attempting to take anything of value from the care, custody, or control of a person by force or threat of force and/or by putting the victim in fear.

SUMMARY

- There were 6,479 robberies reported during 1994.
- Robbery accounted for 2.1 percent of the total Index offenses and 23.1 percent of the violent crimes.
- October recorded the highest number, with 590, while June recorded the lowest with 489.
- Robberies occurring on highways (streets, alleys, and sidewalks) recorded the highest number, with 3,438, or 53.1 percent of all robberies.
- Gas or service station robberies had the lowest number, with 104, or 1.6 percent of all robberies.
- Robberies occurring on highways (streets, alleys, and sidewalks) had the highest total dollar loss, with \$2,510,207.
- Bank robberies had the highest dollar loss per robbery, with \$4,561.
- Firearms represented the most common weapon used in 2,606 robberies, or 40.2 percent.

ARRESTS/CLEARANCES

- A total of 1,519 persons were arrested in 1994.
- Adults accounted for 1,084 arrests and juveniles accounted for 435 arrests.
- Males accounted for 90.7 percent and females accounted for 9.3 percent.
- There were a total of 1,575 clearances for robbery reported in 1994. Juveniles represented 17.3 percent of this total.

ROBBERY BY POPULATION GROUP

	1	2	3	4	5	6	7
Population Group	Over 250,000	100,001 To 250,000	50,001 To 100,000	25,001 To 50,000	10,001 To 25,000	10,000 Or Less	Ungrouped
Robbery	5,021	754	195	140	230	125	14
Distribution	77.5%	11.6%	3.0%	2.2%	3.6%	1.9%	0.2%

ROBBERY BY LOCATION & VALUE

LOCATION	NUMBER OF OFFENSES	DISTRIBUTION (%)	TOTAL DOLLAR VALUE STOLEN	AVERAGE DOLLAR VALUE STOLEN
Highway	3,438	53.1%	\$2,510,207	\$730
Commercial House	974	15.0%	1,211,615	1,244
Gas or Service Station	104	1.6%	18,788	181
Convenience Store	766	11.8%	100,374	131
Residence	586	9.1%	852,036	1,454
Bank	126	1.9%	574,731	4,561
Miscellaneous	485	7.5%	218,142	450
TOTAL	6,479	100.0%	\$5,485,893	\$847

ROBBERY BY MONTH & WEAPON USED

WEAPON	TOTAL	DIST. (%)	JAN	FEB	MAR	APR	MAY	JUN	JUL	AUG	SEPT	OCT	NOV	DEC
Firearm	2,606	40.2%	233	219	234	246	180	169	199	209	225	243	218	231
Knife or Cutting Instrument	678	10.5%	56	42	60	48	63	53	57	50	71	66	50	62
Other Dangerous Weapons	637	9.8%	45	67	53	50	49	50	50	44	71	50	58	50
Strong Arm	2,558	39.5%	196	199	196	219	198	217	190	235	222	231	243	212
TOTAL	6,479	---	530	527	543	563	490	489	496	538	589	590	569	555
Distribution Percentage	---	100.0%	8.2%	8.1%	8.4%	8.7%	7.6%	7.5%	7.6%	8.3%	9.1%	9.1%	8.8%	8.6%

AGGRAVATED ASSAULT

DEFINITION

The unlawful attack by one person upon another for the purpose of inflicting severe bodily injury usually accompanied by the use of a weapon or other means likely to produce death or serious bodily harm.

SUMMARY

- There were 19,704 aggravated assaults reported during 1994.
- Aggravated assault accounted for 6.3 percent of the total Index offenses and 70.4 percent of the violent crimes.
- September recorded the highest number, with 1,943, while January recorded the lowest with 1,425.
- Firearms represented the most common weapon used in 7,023 aggravated assaults, or 35.6 percent.
- There were 49,074 simple assaults reported in 1994. Simple assault is primarily differentiated from aggravated assault by the seriousness of the injury and the weapon used. Simple assault is not a Crime Index offense but is reported here for the purpose of showing the total assault violence.

ARRESTS/CLEARANCES

- A total of 7,508 persons were arrested in 1994.
- Adults accounted for 5,774 arrests and juveniles accounted for 1,734 arrests.
- Males accounted for 85.6 percent and females accounted for 14.4 percent.
- There were a total of 9,451 clearances for aggravated assault reported in 1994. Juveniles represented 17.8 percent of this total.

ASSAULT BY POPULATION GROUP

	1	2	3	4	5	6	7
Population Group	Over 250,000	100,001 To 250,000	50,001 To 100,000	25,001 To 50,000	10,001 To 25,000	10,000 Or Less	Ungrouped
Assault	13,437	2,242	1,158	878	1,111	800	78
Distribution	68.2%	11.4%	5.9%	4.4%	5.6%	4.1%	0.4%

ASSAULT BY WEAPON USED

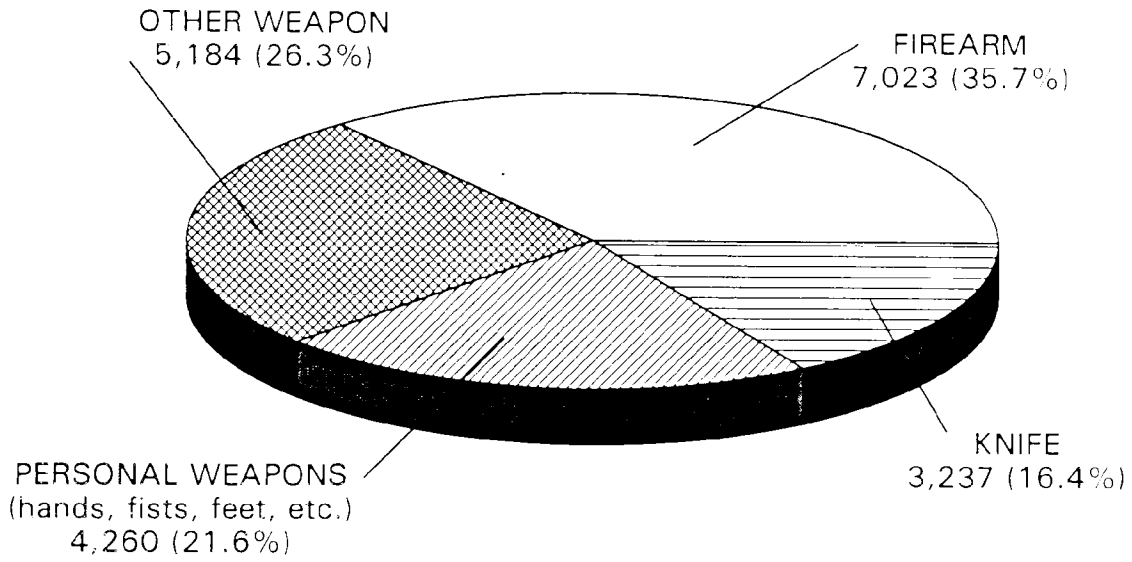

ASSAULT BY MONTH

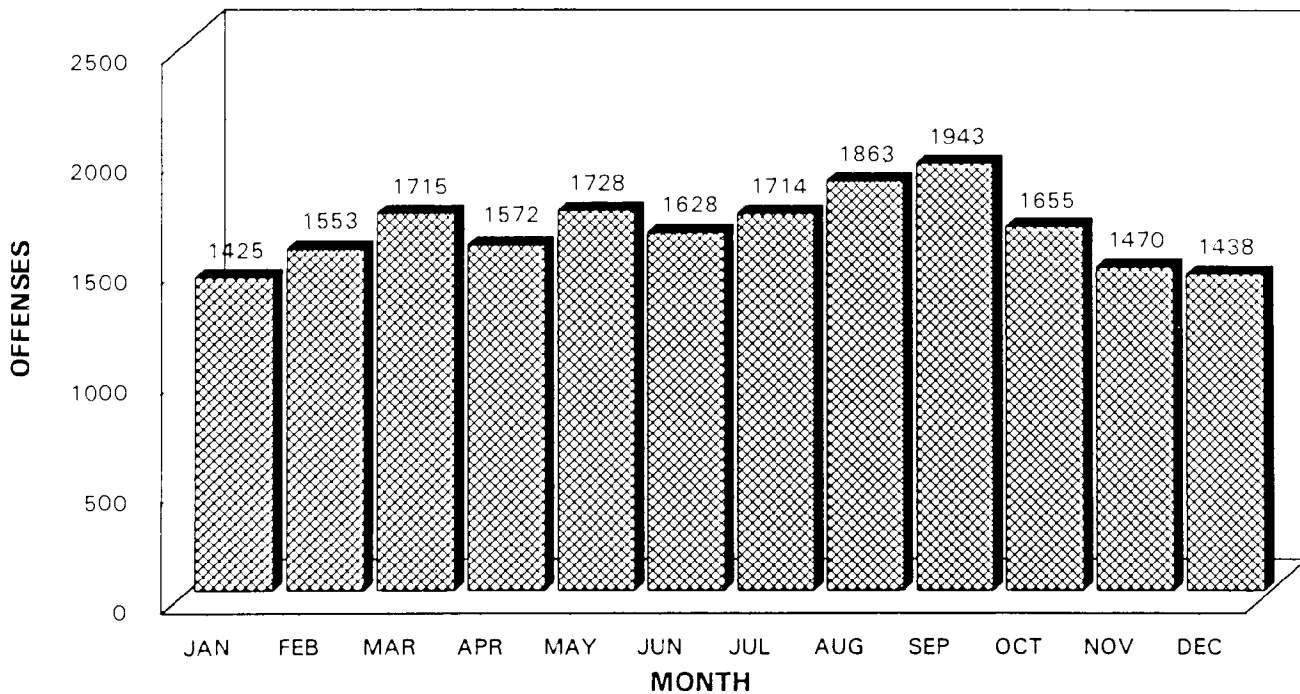

BURGLARY

DEFINITION

The unlawful entry of a structure to commit a felony or theft. The use of force to gain entry is not required to classify the crime as a burglary. A structure is considered to include, but not limited to, the following: dwelling houses, apartments, public buildings, offices, barns, cabins, etc. Burglary is divided into three subclassifications: forcible entry, unlawful entry where no force is used, and attempted forcible entry.

SUMMARY

- There were 58,638 burglaries reported during 1994.
- Burglary accounted for 18.6 percent of the total Index offenses and 20.4 percent of the property crimes.
- August recorded the highest number, with 5,523, while February recorded the lowest with 4,155.
- Forcible entry was used in 34,534, or 58.9 percent of the total burglaries.
- Residential burglaries accounted for 41,956, or 71.6 percent of the total burglaries.
- In burglaries where the time of occurrence was known, 17,189, or 29.3 percent occurred between the hours of 6 AM - 6 PM.
- Residential burglaries accounted for the highest property loss, \$64,358,592.

ARREST/CLEARANCES

- A total of 6,491 persons were arrested in 1994.
- Adults accounted for 3,592 arrests and juveniles accounted for 2,899 arrests.
- Males accounted for 90.0 percent and females accounted for 10.0 percent.
- There were a total of 5,444 clearances for burglary reported in 1994. Juveniles represented 24.1 percent of this total.

BURGLARY BY POPULATION GROUP

	1	2	3	4	5	6	7
Population Group	Over 250,000	100,001 To 250,000	50,001 To 100,000	25,001 To 50,000	10,001 To 25,000	10,000 Or Less	Ungrouped
Burglary	35,841	8,483	4,421	3,627	3,311	2,611	344
Distribution	61.1%	14.5%	7.5%	6.2%	5.6%	4.5%	0.6%

BURGLARY BY LOCATION & TIME

LOCATION	NUMBER OF OFFENSES	DISTRIBUTION	VALUE STOLEN	AVG. VALUE STOLEN
RESIDENCE				
Night (6PM-6AM)	8,249	14.1%	\$14,322,475	\$1,736
Day (6AM-6PM)	14,882	25.4%	21,497,843	1,445
Unknown	18,825	32.1%	28,538,274	1,516
SUBTOTAL	41,956	71.6%	\$64,358,592	\$1,534
NON-RESIDENCE				
Night (6PM-6AM)	5,273	9.0%	\$6,280,999	\$1,191
Day (6AM-6PM)	2,307	3.9%	1,907,588	827
Unknown	9,102	15.5%	13,892,587	1,526
SUBTOTAL	16,682	28.4%	\$22,081,174	\$1,324
TOTAL	58,638	100.0%	\$86,439,766	\$1,474

BURGLARY BY MONTH & MEANS OF ENTRY

ENTRY TYPE	TOTAL	DIST. (%)	JAN	FEB	MAR	APR	MAY	JUN	JUL	AUG	SEPT	OCT	NOV	DEC
Forcible Entry	34,534	58.9%	2,682	2,511	2,780	2,787	2,773	2,649	3,022	3,272	3,118	2,928	2,893	3,119
Unlawful Entry- No Force	20,156	34.4%	1,607	1,366	1,686	1,719	1,685	1,644	1,894	1,847	1,705	1,677	1,618	1,708
Attempted Forcible Entry	3,948	6.7%	287	278	308	334	299	281	373	404	380	372	328	304
TOTAL	58,638	---	4,576	4,155	4,774	4,840	4,757	4,574	5,289	5,523	5,203	4,977	4,839	5,131
Distribution Percentage	---	100.0%	7.8%	7.1%	8.1%	8.3%	8.1%	7.8%	9.0%	9.4%	8.9%	8.5%	8.3%	8.7%

LARCENY-THEFT

DEFINITION

The unlawful taking or stealing of property or articles from the possession of another without the use of force, violence, or fraud. This crime category does not include embezzlement, fraud, counterfeiting, or worthless checks.

SUMMARY

- There were 185,037 larceny-thefts reported during 1994.
- Larceny-theft accounted for 58.8 percent of the total Index offenses and 64.5 percent of the property crimes.
- October recorded the highest number, with 15,020, while April was the lowest with 13,560.
- Larceny-theft in the under \$50 category reported the highest number of incidents, with 91,554, or 49.5 percent.
- Shoplifting accounted for 31,265 larceny-thefts or 16.9 percent.

ARRESTS/CLEARANCES

- A total of 36,281 persons were arrested in 1994.
- Adults accounted for 24,927 arrests and juveniles accounted for 11,354 arrests.
- Males accounted for 70.2 percent and females accounted for 29.8 percent.
- There were a total of 35,404 clearances for larceny-theft reported in 1994. Juveniles represented 24.0 percent of this total.

LARCENY-THEFT BY POPULATION GROUP

	1	2	3	4	5	6	7
Population Group	Over 250,000	100,001 To 250,000	50,001 To 100,000	25,001 To 50,000	10,001 To 25,000	10,000 Or Less	Ungrouped
Larceny-Theft	116,460	26,498	12,807	8,606	8,778	8,849	3,039
Distribution	63.0%	14.3%	6.9%	4.7%	4.7%	4.8%	1.6%

LARCENY-THEFT BY TYPE BY MONTH

CLASSIFICATION	TOTAL	DIST.	JAN	FEB	MAR	APR	MAY	JUN	JUL	AUG	SEPT	OCT	NOV	DEC*
Pocket Picking	302	0.2%	35	12	26	15	22	27	24	25	28	16	32	40
Purse Snatching	706	0.4%	47	54	62	53	52	48	51	60	70	83	63	63
Shoplifting	31,265	16.9%	2,859	2,727	2,628	2,598	2,617	2,474	2,390	2,380	2,411	2,793	2,477	2,911
From Motor Vehicles	31,195	16.9%	2,693	2,564	2,665	2,373	2,367	2,422	2,542	2,534	2,532	2,763	2,734	3,006
Motor Vehicle Parts and/or Accessories	26,915	14.5%	2,333	2,193	2,335	2,057	2,077	2,214	2,209	2,218	2,031	2,335	2,452	2,461
Bicycles	14,544	7.9%	1,025	1,029	1,168	1,166	1,326	1,351	1,267	1,278	1,342	1,342	1,223	1,027
From Buildings	11,872	6.4%	962	1,013	1,004	938	955	1,011	926	999	1,032	1,038	976	1,018
From Coin Operated Machines	1,547	0.8%	151	118	125	149	113	137	137	134	110	138	136	99
All Other	66,691	36.0%	4,869	4,563	4,297	4,211	4,149	4,193	4,222	4,481	4,242	4,512	4,293	18,659
TOTAL	185,037	---	14,974	14,273	14,310	13,560	13,678	13,877	13,768	14,109	13,798	15,020	14,386	29,284

*One agency determined they had under reported their larceny-thefts for 1994. The additional offenses were included in the December figures, since the agency was unable to provide a monthly breakdown.

LARCENY-THEFT BY VALUE BY MONTH

VALUE	TOTAL	DIST.	JAN	FEB	MAR	APR	MAY	JUN	JUL	AUG	SEPT	OCT	NOV	DEC*
Over \$200	58,809	31.8%	4,866	4,746	4,956	4,447	4,619	4,780	4,633	5,012	4,955	5,056	5,182	5,557
\$50 to \$200	34,674	18.7%	2,828	2,580	2,809	2,758	2,922	2,863	2,782	2,865	2,910	3,091	3,015	3,251
Under \$50	91,554	49.5%	7,280	6,947	6,545	6,355	6,137	6,234	6,353	6,232	5,933	6,873	6,189	20,476
TOTAL	185,037	---	14,974	14,273	14,310	13,560	13,678	13,877	13,768	14,109	13,798	15,020	14,386	29,284

*One agency determined they had under reported their larceny-thefts for 1994. The additional offenses were included in the December figures, since the agency was unable to provide a monthly breakdown.

LARCENY-THEFT BY CLASSIFICATION & VALUE

CLASSIFICATION BY VALUE OF PROPERTY STOLEN	NUMBER OF OFFENSES	TOTAL VALUE STOLEN	AVERAGE VALUE	PERCENT DISTRIBUTION (VALUE)
\$200 and Over	58,809	\$68,513,432	\$1,165	92.5%
\$50 to \$200	34,674	3,758,331	108	5.1%
Under \$50	91,554	1,792,252	20	2.4%
TOTAL	185,037	\$74,064,015	\$400	100.0%

ADDITIONAL ANALYSIS

CLASSIFICATION	NUMBER OF OFFENSES	TOTAL VALUE STOLEN	AVERAGE VALUE	PERCENT DISTRIBUTION (VALUE)
Pocket Picking	302	\$48,368	\$160	0.1%
Purse Snatching	706	138,294	196	0.2%
Shoplifting	31,265	2,080,053	67	2.8%
From Motor Vehicles	31,195	15,123,611	485	20.4%
Motor Vehicle Parts and Accessories	26,915	7,971,624	296	10.8%
Bicycles	14,544	4,021,106	276	5.4%
From Buildings	11,872	8,978,319	756	12.1%
From Coin Operated Machines	1,547	192,287	124	0.3%
All Other	66,691	35,510,353	532	47.9%
TOTAL	185,037	\$74,064,015	\$400	100.0%

MOTOR VEHICLE THEFT

DEFINITION

The unlawful taking or stealing of a motor vehicle including attempts and joyriding. This definition excludes the taking for temporary use by those persons having lawful access to the vehicle.

SUMMARY

- There were 41,920 motor vehicle thefts reported during 1994.
- Motor vehicle theft accounted for 13.3 percent of the total Index offenses and 14.6 percent of the property crimes.
- December recorded the highest number, with 4,182, while February recorded the lowest with 2,825.
- Autos represented the highest single category of motor vehicle theft, with 27,194, or 64.9 percent.
- Recovered motor vehicles that were locally stolen amounted to 28,125 or a 67.1 percent recovery rate.
- The total dollar loss amounted to \$188,058,742. Of that amount, \$127,036,863 was recovered. The recovered amount reflects the value of the vehicle when recovered and may be lower than the value when stolen because of missing parts or damage.

ARRESTS/CLEARANCES

- A total of 3,418 persons were arrested in 1994.
- Adults accounted for 1,810 arrests and juveniles accounted for 1,608 arrests.
- Males accounted for 85.5 percent and females accounted for 14.5 percent.
- There were a total of 4,841 clearances for motor vehicle theft reported in 1994. Juveniles represented 23.9 percent of this total.

MOTOR VEHICLE THEFT BY POPULATION GROUP

	1	2	3	4	5	6	7
Population Group	Over 250,000	100,001 To 250,000	50,001 To 100,000	25,001 To 50,000	10,001 To 25,000	10,000 Or Less	Ungrouped
Motor Vehicle Theft	31,247	6,414	1,447	1,060	945	658	149
Distribution	74.5%	15.3%	3.4%	2.5%	2.3%	1.6%	0.4%

MOTOR VEHICLE THEFT BY MONTH

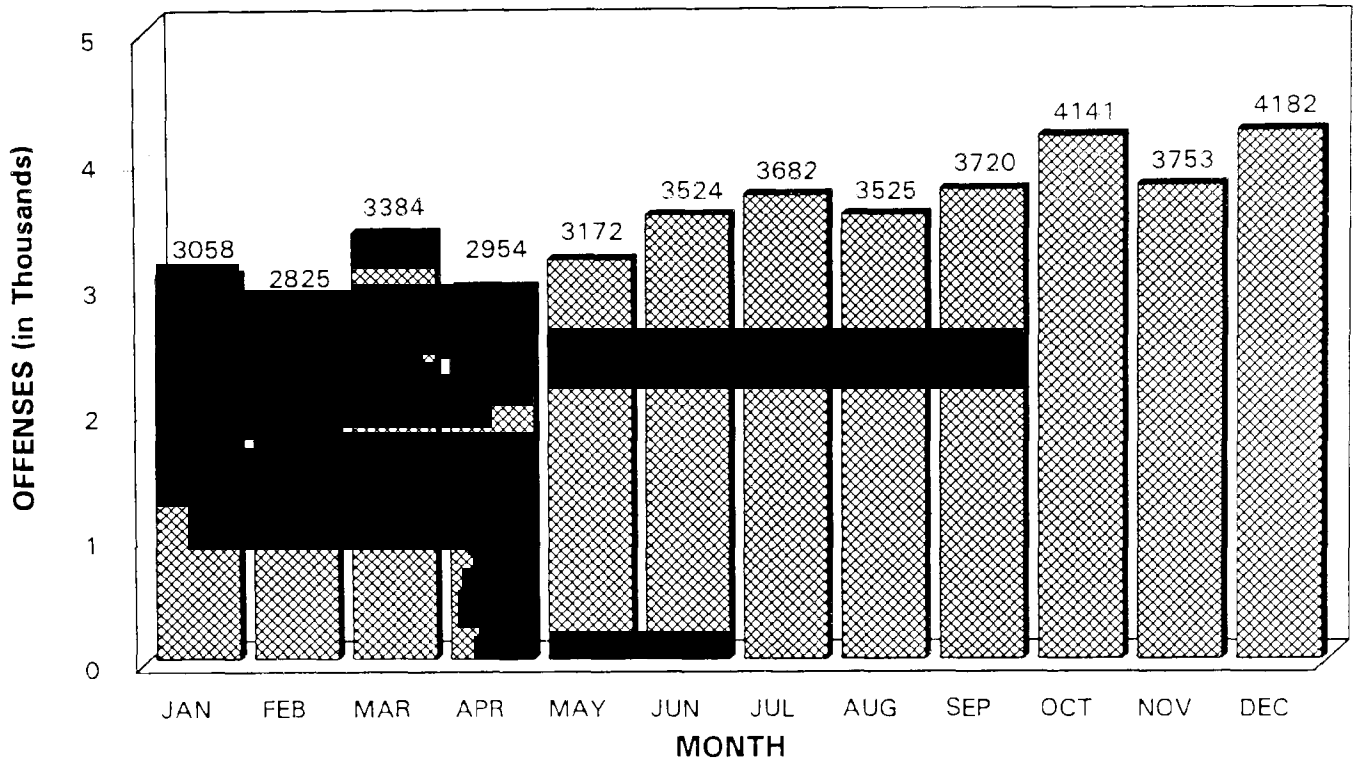

STOLEN VEHICLES BY TYPE

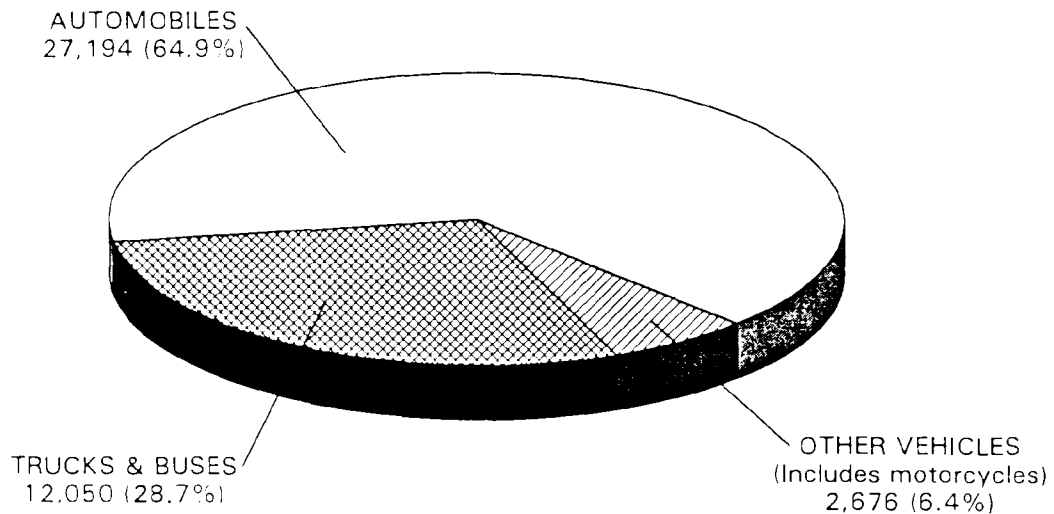

MOTOR VEHICLE RECOVERY INFORMATION

SITUATION	TOTAL	JAN	FEB	MAR	APR	MAY	JUN	JUL	AUG	SEPT	OCT	NOV	DEC
Stolen Locally- Recovered Locally	21,033	1,516	1,444	1,686	1,502	1,580	1,905	1,834	1,756	1,819	2,133	1,910	2,049
Stolen Locally- Recovered by Other Agencies in State	6,352	440	405	459	444	484	513	617	573	605	570	599	643
Stolen Locally- Recovered by Other Agencies out of State	740	45	44	82	57	50	62	66	68	63	76	72	55
SUBTOTAL	28,125	2,001	1,893	2,227	2,003	2,114	2,380	2,517	2,397	2,487	2,779	2,581	2,746
Stolen out of Town- Instate- Recovered Locally	6,207	465	299	450	399	435	519	566	590	600	623	604	657
Stolen out of State- Recovered Locally	874	60	80	72	71	70	65	89	71	69	78	55	94
SUBTOTAL	7,081	525	379	522	470	505	584	655	661	669	701	659	751
TOTAL	35,206	2,526	2,272	2,749	2,473	2,619	2,964	3,172	3,058	3,156	3,480	3,240	3,497

ARSON

DEFINITION

Arson is defined by the national Uniform Crime Reporting Program to include any willful or malicious burning or attempts to burn, with or without intent to defraud, a dwelling house, public building, motor vehicle or aircraft, personal property of another, etc. Fires of suspicious or unknown origins are excluded.

SUMMARY

- There were 1,325 arsons reported during 1994.
- Arson accounted for 0.4 percent of the total Index offenses and 0.5 percent of the property crimes.
- July recorded the highest number, with 131, while November recorded the lowest with 90.
- Structural arson accounted for 688 offenses or 51.9 percent.
- Single occupancy residential arson accounted for the highest single known category, with 279, while industrial/manufacturing arson was the lowest with 9.

ARRESTS/CLEARANCES

- A total of 430 persons were arrested in 1994.
- Adults accounted for 128 arrests and juveniles accounted for 302 arrests.
- Males accounted for 84.9 percent and females accounted for 15.1 percent.
- There were a total of 255 clearances for arson reported in 1994. Juveniles represented 54.9 percent of this total.

ARSON BY POPULATION GROUP

	1	2	3	4	5	6	7
Population Group	Over 250,000	100,001 To 250,000	50,001 To 100,000	25,001 To 50,000	10,001 To 25,000	10,000 Or Less	Ungrouped
Arson	635	250	147	109	101	64	19
Distribution	48.0%	18.9%	11.1%	8.2%	7.6%	4.8%	1.4%

ARSON BY PROPERTY CLASSIFICATION

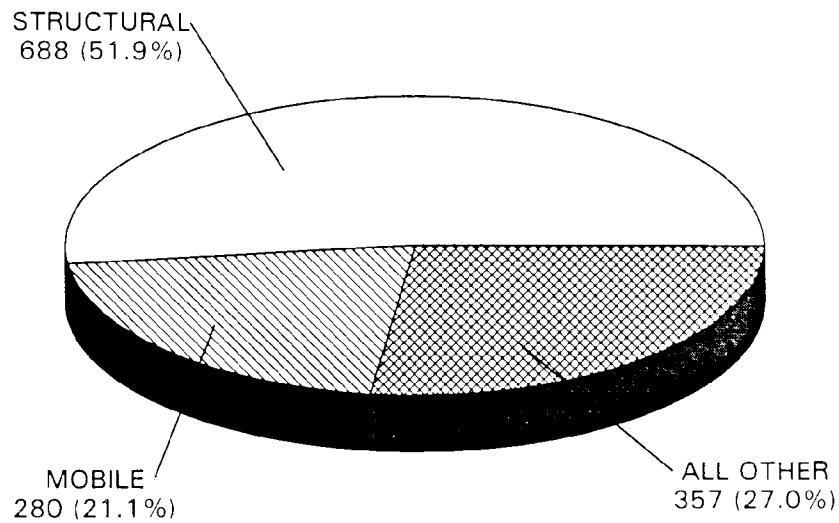

VALUE OF PROPERTY DAMAGED

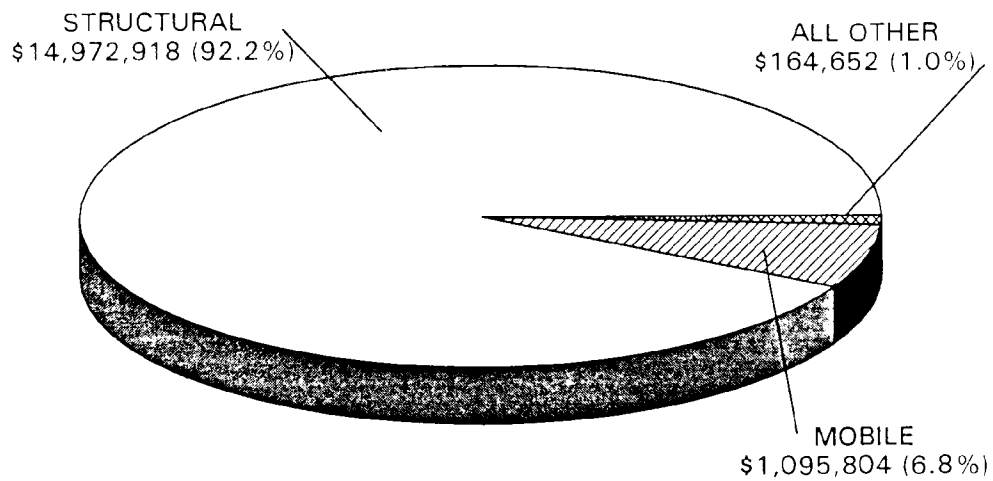

ARSON OFFENSES BY PROPERTY TYPE BY MONTH

PROPERTY CLASSIFICATION	TOTAL	JAN	FEB	MAR	APR	MAY	JUN	JUL	AUG	SEP	OCT	NOV	DEC	VALUE OF PROPERTY DAMAGE
STRUCTURE														
Single Occupancy Residential: Houses, Townhouses, Duplexes, Etc.	279	31	28	26	19	18	18	22	20	33	24	22	18	\$2,547,062
Other Residential: Apartments, Hotels, Motels, Dormitories, Etc.	96	9	4	5	8	9	12	8	10	6	10	7	8	389,816
Storage: Barns, Garages, Warehouses, Etc.	53	3	9	5	4	5	8	4	3	1	1	3	7	1,281,765
Industrial/Manufacturing	9	--	--	--	--	--	3	--	1	--	1	3	1	1,927,800
Other Commercial: Stores, Restaurants, Offices, Etc.	89	6	11	11	9	4	4	7	7	4	12	7	7	7,227,655
Community/Public: Churches, Jails, Schools, Etc.	106	11	8	7	8	8	8	9	2	10	15	8	12	593,580
All Other Monuments, Buildings under Construction, Etc	56	8	3	5	3	5	3	5	6	1	3	7	7	1,005,240
SUBTOTAL	688	68	63	59	51	49	56	55	49	55	66	57	60	\$14,972,918
MOBILE														
Motor Vehicles Autos, Trucks, Buses, Motorcycles, Etc.	243	19	8	16	23	14	24	24	24	27	24	19	21	893,592
All Other: Trailers, Recreational Vehicles, Airplanes, Boats, Etc	37	3	5	4	6	4	3	4	4	--	2	1	1	202,212
SUBTOTAL	280	22	13	20	29	18	27	28	28	27	26	20	22	1,095,804
ALL OTHER														
Crops, Timber, Fences, Signs, Etc.	357	23	24	28	32	29	47	48	40	22	27	13	24	164,652
TOTAL	1,325	113	100	107	112	96	130	131	117	104	119	90	106	\$16,233,374

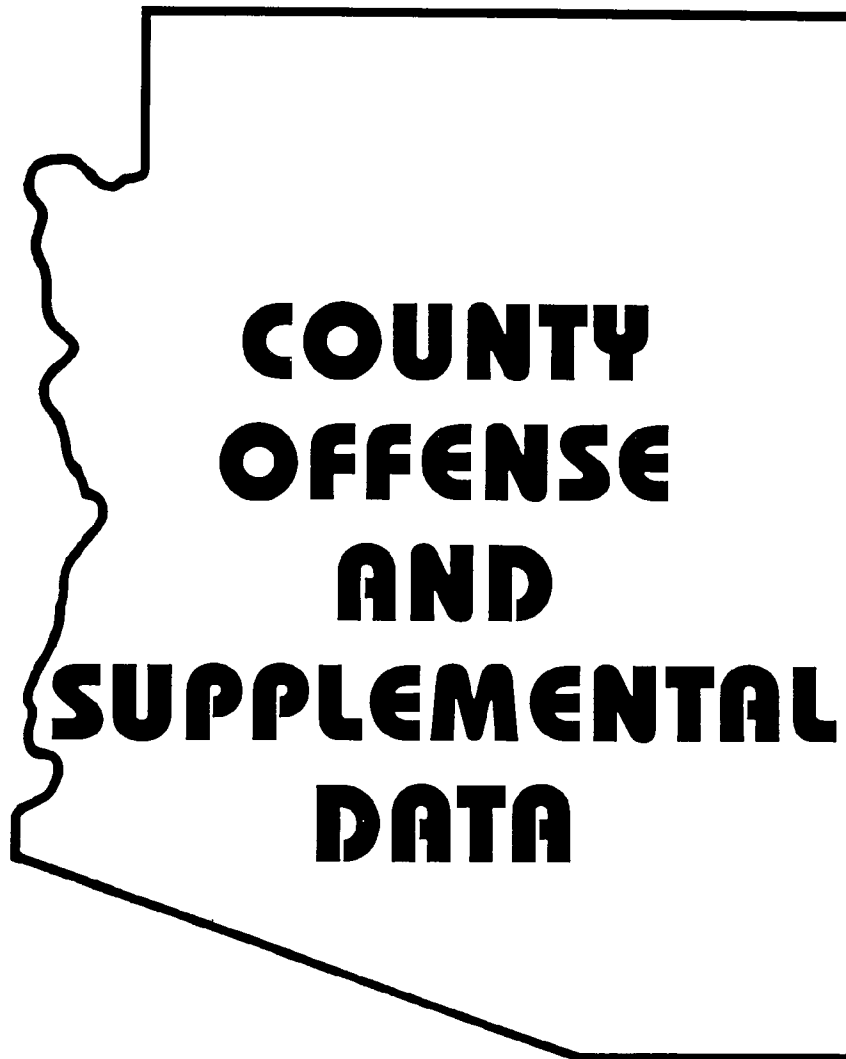

**COUNTY
OFFENSE
AND**

**SUPPLEMENTAL
DATA**

ARIZONA COUNTIES

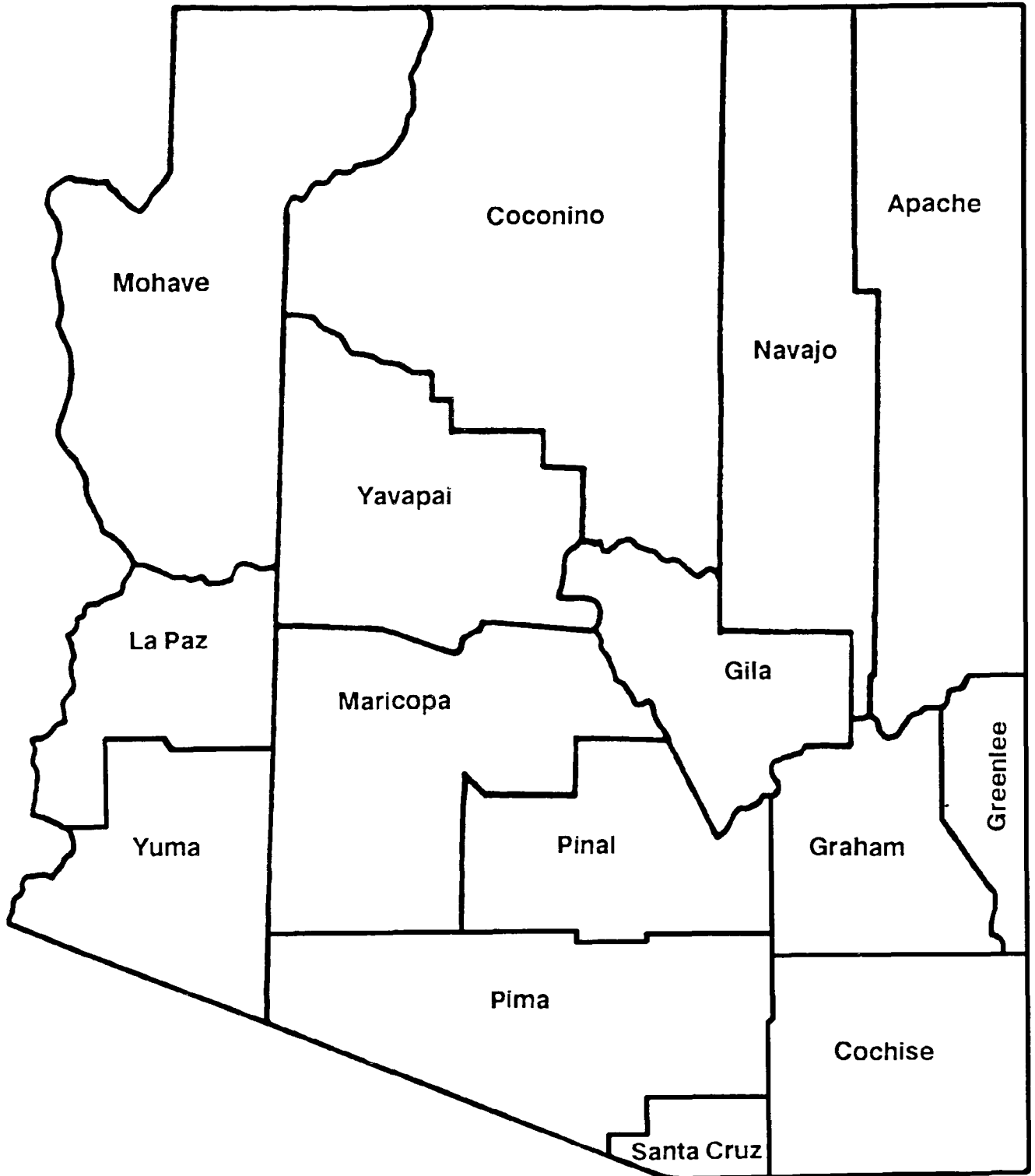

INDEX CRIMES BY COUNTY *

INDEX OFFENSES	APACHE	COCHISE	COCONINO	GILA	GRAHAM	GREENLEE	LA PAZ	MARICOPA	MOHAVE	NAVAJO	PIMA	PINAL	SANTA CRUZ	YAVAPAI	YUMA
MURDER	--	9	7	3	--	--	2	295	13	3	57	12	3	13	2
FORCIBLE RAPE	2	13	49	17	--	--	2	771	35	19	401	61	--	33	6
Rape by Force	2	13	38	16	--	--	1	618	28	15	303	48	--	32	4
Attempts to Commit	--	--	11	1	--	--	1	153	7	4	98	13	--	1	2
ROBBERY	5	32	55	8	--	--	8	4,801	81	24	1,226	91	101	40	7
Firearm	4	16	13	3	--	--	4	2,072	38	7	390	19	23	15	2
Knife/Cutting Instrument	--	2	2	--	--	--	--	491	4	3	142	3	26	2	3
Other Dangerous Weapons	--	6	10	--	--	--	--	373	8	1	222	8	1	8	--
Strong Arm	1	8	30	5	--	--	4	1,865	31	13	472	61	51	15	2
ASSAULT	50	215	329	133	125	1	151	12,330	485	261	4,237	634	164	490	99
Firearm	3	35	62	24	9	--	26	5,183	96	21	1,272	192	16	66	18
Knife/Cutting Instrument	6	18	41	18	9	--	2	2,051	79	33	827	86	19	35	13
Other Dangerous Weapons	14	32	75	56	13	--	28	3,358	99	57	870	215	15	327	25
Physical Force	27	130	151	35	94	1	95	1,738	211	150	1,268	141	114	62	43
BURGLARY	138	743	902	369	91	6	162	39,119	2,184	699	9,858	1,879	521	1,628	339
Forcible Entry	87	442	385	179	53	5	94	22,438	940	450	7,115	1,130	451	566	199
Unlawful Entry-No Force	48	193	420	103	36	1	54	14,297	1,176	218	1,865	616	31	971	127
Attempted Forcible Entry	3	108	97	87	2	--	14	2,384	68	31	878	133	39	91	13
LARCENY-THEFT	575	2,348	5,539	1,260	491	84	302	107,261	4,972	1,809	49,136	4,908	882	4,360	1,110
MOTOR VEHICLE THEFT	23	264	209	70	33	2	48	32,147	560	99	7,286	511	237	329	102
Autos	15	144	140	35	12	1	25	20,476	396	45	5,056	378	157	253	61
Trucks and Buses	5	89	38	20	10	--	4	9,782	80	36	1,813	57	61	29	26
Other Vehicles	3	31	31	15	11	1	19	1,889	84	18	417	76	19	47	15
ARSON	3	29	19	7	--	--	8	793	67	25	259	46	9	55	5
TOTAL	796	3,653	7,109	1,867	740	93	683	197,517	8,397	2,939	72,460	8,142	1,917	6,948	1,670

* Refer to page 13 for those agencies that provided only partial data or no data in 1994.

ANALYSIS OF ROBBERY, BURGLARY, AND LARCENY-THEFT BY COUNTY*

OFFENSES	APACHE	COCHISE	COCONINO	GILA	GRAHAM	GREENLEE	LA PAZ	MARICOPA	MOHAVE	NAVAJO	PIMA	PINAL	SANTA CRUZ	YAVAPAI	YUMA
ROBBERY	5	32	55	8	--	--	8	4,801	81	24	1,226	91	101	40	7
Highway	1	5	31	1	--	--	6	2,629	12	14	699	29	--	7	4
Commercial House	--	4	6	1	--	--	1	807	10	3	132	5	1	4	--
Gas or Service Station	--	1	2	--	--	--	--	69	2	--	27	2	1	--	--
Convenience Store	3	3	6	1	--	--	--	596	7	1	130	13	3	3	--
Residence	1	13	5	3	--	--	--	423	8	2	112	10	--	7	2
Bank	--	--	--	--	--	--	--	88	7	--	28	2	--	1	--
Miscellaneous	--	6	5	2	--	--	1	189	35	4	98	30	96	18	1
BURGLARY	138	743	902	369	91	6	162	39,119	2,184	699	9,858	1,879	521	1,628	339
Residence	108	509	510	200	45	4	116	28,709	1,438	384	6,933	1,224	428	1,093	255
Night, 6PM-6AM	23	120	138	55	16	2	28	5,406	224	79	1,308	460	113	210	67
Day, 6AM-6PM	12	251	184	118	10	--	50	10,753	410	78	1,674	556	221	485	80
Unknown	73	138	188	27	19	2	38	12,550	804	227	3,951	208	94	398	108
Non-Residence	30	234	392	169	46	2	46	10,410	746	315	2,925	655	93	535	84
Night, 6PM-6AM	12	115	171	42	30	2	16	3,246	237	137	678	276	51	233	27
Day, 6AM-6PM	5	42	96	103	4	--	19	1,125	134	30	377	239	26	101	6
Unknown	13	77	125	24	12	--	11	6,039	375	148	1,870	140	16	201	51
LARCENY-THEFT	575	2,348	5,539	1,260	491	84	302	107,261	4,972	1,809	49,136	4,908	882	4,360	1,110
\$200 and Over	133	517	1,902	386	180	44	144	40,969	1,785	430	9,224	1,473	297	1,084	241
\$50 to \$200	112	539	996	302	122	18	77	22,979	1,083	458	5,545	1,188	228	743	284
Under \$50	330	1,292	2,641	572	189	22	81	43,313	2,104	921	34,367	2,247	357	2,533	585
Pocket Picking	1	6	6	1	--	--	3	176	14	4	70	9	3	3	6
Purse Snatching	18	14	23	21	19	1	--	326	37	15	188	17	--	15	12
Shoplifting	65	425	1,027	222	125	13	26	18,638	678	447	7,473	853	341	668	264
From Motor Vehicle	51	206	931	218	82	3	39	21,981	741	200	5,168	644	140	571	220
Motor Vehicle Parts and Accessories	14	210	202	49	15	2	33	21,384	207	99	3,768	442	78	315	97
Bicycles	28	164	368	67	41	2	17	10,440	352	138	2,201	375	21	188	142
From Buildings	130	262	590	235	92	3	33	5,717	416	250	3,129	350	92	448	125
Coin-Operated Machines	1	5	24	3	1	--	6	844	42	30	546	19	--	24	2
All Other	267	1,056	2,368	444	116	60	145	27,755	2,485	626	26,593	2,199	207	2,128	242
TOTAL	718	3,123	6,496	1,637	582	90	472	151,181	7,237	2,532	60,220	6,878	1,504	6,028	1,456

* Refer to page 13 for those agencies that provided only partial data or no data in 1994.

VALUE OF PROPERTY STOLEN BY CRIME BY COUNTY*

OFFENSES	APACHE	COCHISE	COCONINO	GILA	GRAHAM	GREENLEE	LA PAZ	MARICOPA	MOHAVE	NAVAJO	PIMA	PINAL	SANTA CRUZ	YAVAPAI	YUMA
MURDER		700						23,066			1,500	1			
FORCIBLE RAPE								58,302			5,507				
ROBBERY	4,132	43,246	7,960	6,509			4,642	4,716,891	90,121	39,641	509,047	20,111	25,885	17,133	575
Highway	1,500	561	2,246	400			4,252	2,182,981	35,805	17,041	253,711	3,478		8,157	75
Commercial House		7,939	4,076	100			210	1,114,781	529	325	82,805	420	400	30	
Gas or Service Station			158					13,261	4,715		421	133	100		
Convenience Store	632	61	880	102				92,560	1,443	107	2,924	697	460	508	
Residence	2,000	33,885	480	5,107				650,527	2,593	15,820	124,966	11,693		4,915	50
Bank								540,347	11,306		23,068	10			
Miscellaneous		800	120	800			180	122,434	33,730	6,348	21,152	3,680	24,925	3,523	450
BURGLARY	87,254	1,209,300	820,931	399,821	66,444	3,390	130,756	63,260,002	2,726,356	946,729	12,417,604	2,405,220	326,290	1,375,818	263,851
Residence	55,222	984,804	522,640	274,166	35,170	2,800	91,589	47,383,991	1,848,186	394,779	9,899,280	1,442,983	297,377	946,506	179,099
Night, 6PM-6AM	4,158	158,457	85,820	41,333	14,285	2,500	19,784	11,619,731	184,774	50,160	1,307,315	538,115	69,861	181,769	44,413
Day, 6AM-6PM	1,731	550,216	296,258	207,077	2,985		44,994	16,590,745	423,302	66,471	2,070,750	646,254	155,723	379,052	62,285
Unknown	49,333	276,131	140,562	25,756	17,900	300	26,811	19,173,515	1,240,110	278,148	6,521,215	258,614	71,793	385,685	72,401
Non-Residence	32,032	224,496	298,291	125,655	31,274	590	39,167	15,876,011	878,170	551,950	2,518,324	962,237	28,913	429,312	84,752
Night, 6PM-6AM	17,817	82,465	146,694	22,637	23,651	590	6,459	4,184,361	269,215	127,431	568,782	617,607	11,847	190,012	11,431
Day, 6AM-6PM	1,845	20,848	80,887	93,695	1,114		26,298	1,096,444	54,055	10,276	146,470	272,537	8,986	93,116	1,017
Unknown	12,370	121,183	70,710	9,323	6,509		6,410	10,595,206	554,900	414,243	1,803,072	72,093	8,080	146,184	72,304
LARCENY-THEFT	171,188	938,278	1,873,046	490,974	272,958	44,446	257,435	52,150,037	3,135,942	407,411	10,278,988	1,840,630	355,468	1,585,294	261,920
\$200 and Over	156,387	865,672	1,700,167	453,997	256,849	41,909	248,025	48,420,498	2,990,689	344,783	9,314,645	1,682,882	322,211	1,490,328	224,390
\$50 to \$200	10,851	53,939	107,100	31,138	12,610	2,097	8,293	2,609,308	114,797	49,389	506,050	120,822	24,905	75,993	31,039
Under \$50	3,950	18,667	65,779	5,839	3,499	440	1,117	1,120,231	30,456	13,239	458,293	36,926	8,352	18,973	6,491
Pocket-Picking	100	296	909	23			910	28,150	2,999	45	11,065	1,375	368	93	2,035
Purse Snatching	4,081	545	4,831	4,027	3,251	200		74,316	8,839	3,763	24,609	5,193		2,027	2,612
Shoplifting	1,147	27,250	47,504	4,848	5,564	552	2,340	1,502,194	33,036	8,500	371,842	29,661	20,115	17,327	8,173
From Motor Vehicle	13,527	39,395	403,664	65,792	35,357	2,310	33,390	10,738,860	300,598	76,647	2,686,894	352,307	85,954	240,044	48,872
Motor Vehicle Parts and Accessories	2,030	27,822	40,163	8,442	3,261	1,675	8,160	6,631,543	76,376	17,417	873,872	110,728	49,051	91,587	29,497
Bicycles	2,554	16,944	140,844	13,750	6,579	400	2,633	2,896,944	99,933	20,034	666,885	65,682	4,645	61,333	21,940
From Buildings	31,752	367,850	287,023	112,463	83,039	5,565	20,089	4,348,030	357,411	103,357	2,505,851	219,296	99,658	339,479	97,456
Coin-Operated Machines	3	620	5,147	537	10		923	111,478	5,921	4,528	55,666	3,600		3,818	30
All Other	115,994	457,556	942,961	281,092	135,897	33,744	188,990	25,818,522	2,250,829	173,120	3,082,304	1,052,782	95,677	829,586	51,299
MOTOR VEHICLE THEFT	100,419	1,543,309	1,180,115	400,859	142,707	3,600	136,848	148,334,752	2,201,898	621,853	28,011,771	2,706,208	1,797,230	963,315	324,035
TOTAL	362,993	3,734,833	3,882,052	1,298,163	482,109	51,436	529,681	268,543,050	8,154,317	2,015,634	51,224,417	6,972,170	2,504,873	3,941,560	850,381

*Refer to page 13 for those agencies that provided only partial data or no data in 1994.

TYPE AND VALUE, IN DOLLARS, OF PROPERTY STOLEN AND RECOVERED BY COUNTY*

STOLEN	APACHE	COCHISE	COCONINO	GILA	GRAHAM	GREENLEE	LA PAZ	MARICOPA	MOHAVE	NAVAJO	PIMA	PINAL	SANTA CRUZ	YAVAPAI	YUMA
Currency/Notes/Etc	60,465	362,707	389,316	89,375	134,329	1,795	73,618	6,730,100	524,114	469,829	1,289,959	283,975	106,054	383,752	37,247
Jewelry/Precious Metals	42,293	305,433	393,648	92,084	10,974	6,400	37,935	21,340,794	632,619	79,962	5,245,213	576,646	140,436	377,335	63,467
Clothing and Furs	2,296	28,146	148,319	9,596	567	167	15,420	3,538,076	115,190	71,192	894,762	99,244	47,972	56,590	11,529
Locally Stolen Vehicles	97,400	1,556,223	1,180,115	383,265	142,088	3,600	125,556	148,359,582	2,264,205	616,371	27,831,125	2,366,372	1,794,930	1,015,053	322,857
Office Equipment	5,492	52,257	63,312	8,542	5,688	109	3,856	10,131,194	117,231	11,613	1,123,506	44,152	15,529	38,622	2,931
Stereos/TV's/Cameras	23,124	257,899	385,328	88,111	66,306	5,038	43,338	27,036,462	559,869	168,423	5,056,997	598,197	148,200	433,221	111,714
Firearms	14,941	67,523	56,407	40,464	5,819	3,652	15,220	2,961,242	163,772	87,531	595,066	166,225	23,172	170,586	17,850
Household Goods	16,472	138,906	93,245	27,086	25,095	300	27,963	5,340,052	331,637	101,512	985,036	140,988	13,097	136,620	43,136
Consumable Goods	7,134	29,703	33,517	8,030	4,325	644	4,364	916,372	74,933	30,845	110,387	41,491	9,994	18,531	3,950
Livestock	300	2,654	2,105	880	1,350	--	--	37,926	1,745	80	65,696	22,300	1,150	1,130	1,250
Miscellaneous	93,076	933,382	1,136,740	550,730	83,568	29,731	182,411	42,151,250	3,369,002	378,276	8,026,670	2,632,580	204,339	1,310,120	234,450
TOTAL STOLEN	362,993	3,734,833	3,882,052	1,298,163	482,109	51,436	529,681	268,543,050	8,154,317	2,015,634	51,224,417	6,972,170	2,504,873	3,941,560	850,381
RECOVERED															
Currency/Notes/Etc	3,525	30,432	14,066	3,950	64,770	1,000	652	366,997	19,805	5,120	25,678	49,118	9,564	49,688	852
Jewelry/Precious Metals	17,016	40,751	39,437	21,329	--	--	1,349	830,528	54,996	13,266	56,528	25,757	6,491	5,891	1,006
Clothing and Furs	152	3,560	220,156	1,993	124	82	713	522,159	9,783	52,987	84,508	9,933	13,045	4,534	1,821
Locally Stolen Vehicles	81,300	800,549	774,395	292,843	104,160	2,500	45,346	109,581,855	1,912,922	545,989	10,086,450	1,723,663	368,010	609,465	107,416
Office Equipment	2,740	3,527	4,314	438	--	--	1,540	409,452	31,940	4,594	28,511	6,752	1,425	498	217
Stereos/TV's/Cameras	6,944	18,028	21,605	16,616	23,376	--	4,298	743,325	58,019	16,276	110,332	37,506	3,010	29,964	4,751
Firearms	3,000	10,075	6,211	10,326	1,365	1,512	901	244,712	17,369	35,605	66,475	14,582	180	14,052	3,440
Household Goods	233	1,294	39,202	1,964	200	--	2,081	194,098	31,076	16,782	13,714	5,388	144	13,006	410
Consumable Goods	531	3,311	4,860	1,008	2,628	73	286	177,613	36,301	5,235	11,925	8,312	1,489	5,103	1,606
Livestock	--	1,500	700	300	1,100	--	--	4,317	1,020	--	500	1,700	--	1,000	--
Miscellaneous	11,579	55,969	213,956	167,557	10,952	3,625	25,054	4,546,535	612,367	51,610	271,885	706,661	13,596	55,363	13,393
TOTAL RECOVERED	127,020	968,996	1,338,902	518,324	208,675	8,792	82,220	117,621,591	2,785,598	747,464	10,756,506	2,589,372	416,954	788,564	134,912

* Refer to page 13 for those agencies that provided only partial data or no data in 1994.



**STATE
AND COUNTY
ARREST
DATA**

ARREST SUMMARY

- There were a total of 271,986 arrests reported in 1994.
- Arrests for Part I offenses amounted to 56,222, or 20.7 percent.
- Arrests for Part II offenses amounted to 215,764, or 79.3 percent.
- Adult arrests were 207,339, or 76.2 percent, and juvenile arrests were 64,647, or 23.8 percent.
- Males accounted for 214,559 arrests, or 78.9 percent, and females accounted for 57,427, or 21.1 percent.
- Arrests for adults between the ages of 25-29 recorded the highest number with 38,004, or 18.3 percent of the total adult arrests.
- Arrests for juveniles age 12 and under were 6,883, or 10.6 percent of the total juvenile arrests.
- Larceny-theft recorded the highest number of arrests of a specific offense with 36,281, or 13.3 of the total.

ARREST BY AGE GROUP

PART 1 OFFENSES	ADULT		JUVENILE	
	ARRESTS	DISTRIBUTION	ARRESTS	DISTRIBUTION
Murder/Manslaughter	260	0.7%	69	0.4%
Forcible Rape	212	0.5%	34	0.2%
Robbery	1,084	2.9%	435	2.4%
Aggravated Assault	5,774	15.3%	1,734	9.4%
Burglary	3,592	9.5%	2,899	15.7%
Larceny-Theft	24,927	56.0%	11,354	61.6%
Motor Vehicle Theft	1,810	4.8%	1,608	8.7%
Arson	128	0.3%	302	1.6%
TOTAL	37,787	100.0%	18,435	100.0%

ARREST BY OFFENSE, RACE & ETHNIC ORIGIN

OFFENSE CLASSIFICATION	NUMBER of ARRESTS	DIST.	WHITE	BLACK	INDIAN	ASIAN	HISPANIC	NOT HISPANIC
PART I								
Murder/Nonneg. Manslaughter	329	0.12%	263	51	15	--	119	210
Forcible Rape	246	0.09%	189	46	9	2	75	171
Robbery	1,519	0.56%	1,024	422	67	6	507	1,012
Aggravated Assault	7,508	2.76%	6,299	826	330	53	2,253	5,255
Burglary	6,491	2.38%	5,565	649	223	54	1,896	4,595
Larceny-Theft	36,281	13.34%	30,241	3,863	1,933	244	10,176	26,105
Motor Vehicle Theft	3,418	1.26%	2,994	328	89	7	1,256	2,162
Arson	430	0.16%	396	23	10	1	81	349
PART I SUBTOTAL	56,222	20.67%	46,971	6,208	2,676	367	16,363	39,859
PART II								
Manslaughter by Negligence	37	0.01%	30	2	5	--	10	27
Other Assaults - Simple	28,177	10.36%	23,647	2,818	1,562	150	7,806	20,371
Forgery and Counterfeiting	1,831	0.67%	1,606	188	26	11	362	1,469
Fraud	1,857	0.68%	1,568	224	44	21	227	1,630
Embezzlement	221	0.08%	181	39	1	--	44	177
Stolen Property	3,228	1.19%	2,815	334	64	15	958	2,270
Vandalism	10,208	3.75%	8,919	810	422	57	2,935	7,273
Weapons: Carrying, Possessing	4,504	1.65%	3,812	620	57	15	1,518	2,986
Prostitution and Comm. Vice	1,755	0.65%	1,325	370	49	11	313	1,442
Sex Offenses	2,059	0.76%	1,752	161	133	13	465	1,594
DRUGS, SALE OR MFG								
Opium, Cocaine, Derivatives	1,030	0.38%	776	247	5	2	511	519
Marijuana	1,456	0.53%	1,336	81	31	8	538	918
Synthetic Narcotics	629	0.23%	533	91	4	1	124	505
Other Dangerous Nonnarcotics	1,675	0.62%	1,619	42	11	3	149	1,526
DRUGS, POSSESSION								
Opium, Cocaine, Derivatives	1,842	0.68%	1,469	341	27	5	647	1,195
Marijuana	10,356	3.81%	9,279	689	338	50	2,897	7,459
Synthetic Narcotics	1,812	0.67%	1,618	167	24	3	428	1,384
Other Dangerous Nonnarcotics	2,743	1.01%	2,406	259	62	16	645	2,098
All Gambling	26	0.01%	22	3	--	1	10	16
Offenses Against Family/Children	2,044	0.75%	1,754	117	159	14	392	1,652
Driving Under the Influence	26,625	9.79%	23,726	705	2,095	99	7,464	19,161
Liquor Laws	22,064	8.11%	18,353	1,257	2,367	87	6,249	15,815
Disorderly Conduct	22,338	8.21%	18,807	1,852	1,561	118	5,910	16,428
Vagrancy	824	0.31%	476	88	255	5	172	652
All Other, Except Traffic	49,447	18.18%	41,026	4,619	3,649	153	11,968	37,479
Curfew/Loitering (Juveniles)	8,822	3.24%	7,954	669	157	42	3,924	4,898
Runaways (Juveniles)	8,154	3.00%	7,507	416	165	66	1,893	6,261
PART II SUBTOTAL	215,764	79.33%	184,316	17,209	13,273	966	58,559	157,205
TOTAL	271,986	100.00%	231,287	23,417	15,949	1,333	74,922	197,064
	Distribution		85.04%	8.61%	5.86%	0.49%	27.55%	72.45%

TOTAL ARRESTS BY AGE

OFFENSE CLASSIFICATION	UNDER 10	10-12	13-14	15	16	17	TOTAL UNDER 18	18	19	20	21
PART I											
Murder/Nonneg. Manslaughter	--	--	8	14	23	24	69	26	20	20	12
Forcible Rape	--	2	12	4	7	9	34	6	4	12	13
Robbery	4	22	104	95	108	102	435	104	68	65	57
Aggravated Assault	39	199	487	277	388	344	1,734	325	267	233	227
Burglary	92	339	784	625	525	534	2,899	393	327	199	180
Larceny-Theft	284	1,656	3,762	2,055	1,898	1,699	11,354	1,650	1,313	1,079	1,006
Motor Vehicle Theft	3	86	414	375	405	325	1,608	237	147	121	100
Arson	64	85	101	21	22	9	302	6	4	2	2
PART I SUBTOTAL	486	2,389	5,672	3,466	3,376	3,046	18,435	2,747	2,150	1,731	1,597
PART II											
Manslaughter by Negligence	--	--	1	1	--	1	3	1	2	--	--
Other Assaults - Simple	111	620	1,424	914	880	836	4,785	673	758	788	858
Forgery and Counterfeiting	--	7	15	25	48	52	147	67	99	89	79
Fraud	--	2	9	13	31	37	92	71	89	60	68
Embezzlement	1	1	1	6	6	8	23	9	18	8	10
Stolen Property	3	26	197	158	177	181	742	205	163	156	136
Vandalism	192	613	1,170	707	729	561	3,972	458	337	281	271
Weapons: Carrying, Possessing	2	42	212	160	256	280	952	322	318	234	229
Prostitution and Comm. Vice	--	1	3	5	4	7	20	24	52	45	60
Sex Offenses	27	38	116	53	35	38	307	42	51	56	42
DRUGS, SALE OR MFG.											
Opium, Cocaine, Derivatives	--	--	21	26	34	46	127	44	42	47	42
Manjuana	--	12	73	59	44	65	253	63	92	58	58
Synthetic Narcotics	--	2	11	8	7	12	40	18	23	22	27
Other Dangerous Nonnarcotics	3	4	25	19	37	29	117	45	63	54	56
DRUGS, POSSESSION											
Opium, Cocaine, Dervatives	--	2	12	19	35	58	126	58	67	74	54
Manjuana	5	123	546	491	608	690	2,463	732	724	578	470
Synthetic Narcotics	--	3	31	19	45	75	173	63	75	62	88
Other Dangerous Nonnarcotics	--	34	161	123	158	155	631	163	111	96	78
All Gambling	--	1	2	2	1	3	9	1	1	2	--
Offenses Against Family/Children	--	--	--	--	--	--	--	56	55	56	61
Drving Under the Influence	2	2	4	11	67	196	282	393	516	702	1,016
Liquor Laws	4	46	463	694	1,317	1,921	4,445	2,650	2,790	2,216	544
Disorderly Conduct	64	348	1,193	820	812	728	3,965	892	788	705	938
Vagrancy	--	1	14	12	17	14	58	39	39	20	27
All Other, Except Traffic	118	478	1,502	1,110	1,199	1,097	5,504	1,858	1,996	1,922	2,047
Curfew/Loitering (Juveniles)	27	376	2,271	1,979	2,174	1,995	8,822	--	--	--	--
Runaways (Juveniles)	54	613	2,923	1,907	1,740	917	8,154	--	--	--	--
PART II SUBTOTAL	613	3,395	12,400	9,341	10,461	10,002	46,212	8,947	9,269	8,331	7,259
TOTAL	1,099	5,784	18,072	12,807	13,837	13,048	64,647	11,694	11,419	10,062	8,856

22	23	24	25-29	30-34	35-39	40-44	45-49	50-54	55-59	60-64	65 AND OVER	TOTAL OVER '65	TOTAL ALL AGES
13	7	14	40	36	31	12	14	4	3	3	5	260	329
7	12	8	52	43	28	13	6	5	2	1	--	212	246
65	63	63	208	187	119	59	13	10	2	1	--	1,084	1,519
259	253	230	1,105	1,099	773	431	274	134	64	45	55	5,774	7,508
165	163	143	646	595	401	239	80	29	17	8	7	3,592	5,491
992	959	898	4,285	4,400	3,505	2,229	1,095	561	296	256	403	24,927	36,281
90	86	90	352	279	174	80	31	15	3	--	5	1,810	3,418
5	2	1	18	33	20	10	8	6	5	2	4	128	430
1,596	1,545	1,447	6,706	6,672	5,051	3,073	1,521	764	392	316	479	37,787	56,222
--	--	--	7	9	5	5	1	1	1	1	1	34	37
923	1,038	1,091	4,913	4,980	3,458	1,995	974	442	243	129	129	23,392	28,177
79	96	73	362	358	197	105	51	19	4	4	2	1,684	1,831
63	75	62	346	359	252	146	68	50	23	19	14	1,765	1,857
8	15	4	45	33	21	10	6	6	--	1	4	198	221
117	143	139	530	428	250	123	59	24	9	1	3	2,486	3,228
277	266	252	1,259	1,162	795	454	204	105	58	21	36	6,236	10,208
201	189	174	689	533	298	192	85	53	15	8	12	3,552	4,504
76	58	102	420	384	267	149	54	15	12	9	8	1,735	1,755
38	62	68	283	334	293	182	117	67	46	25	46	1,752	2,059
47	48	45	197	165	109	57	31	13	9	4	3	903	1,030
65	66	65	244	199	142	75	37	22	8	5	4	1,203	1,456
36	18	21	124	134	77	40	27	8	7	3	4	589	629
75	81	87	362	391	217	84	32	9	1	--	1	1,558	1,675
78	76	55	387	335	286	150	64	22	8	2	--	1,716	1,842
390	428	392	1,500	1,225	779	415	161	58	16	13	12	7,893	10,356
75	77	93	351	365	218	105	44	14	4	3	2	1,639	1,812
90	80	100	456	391	308	153	61	11	6	--	8	2,112	2,743
1	--	3	--	4	--	1	1	2	1	--	--	17	25
69	57	86	405	468	359	195	86	38	27	13	13	2,044	2,044
1,041	1,137	1,108	5,087	4,692	3,871	2,719	1,739	1,040	577	358	347	26,343	26,625
382	391	310	1,370	1,573	1,661	1,465	877	559	393	233	205	17,619	22,064
814	843	786	3,236	3,270	2,438	1,726	867	453	261	163	193	18,373	22,338
20	18	28	111	137	104	120	46	22	18	9	8	766	824
1,933	1,929	2,004	8,614	8,233	5,899	3,627	1,806	904	545	305	321	43,943	49,447
--	--	--	--	--	--	--	--	--	--	--	--	--	8,822
--	--	--	--	--	--	--	--	--	--	--	--	--	8,154
6,898	7,191	7,148	31,298	30,162	22,304	14,293	7,498	3,957	2,292	1,329	1,376	169,552	215,764
8,494	8,736	8,595	38,004	36,834	27,355	17,366	9,019	4,721	2,684	1,645	1,855	207,339	271,986

JUVENILE MALE ARRESTS

OFFENSE CLASSIFICATION	AGE						TOTAL JUVENILE
	UNDER 10	10-12	13-14	15	16	17	
PART I							
Murder/Nonneg. Manslaughter	--	--	7	11	21	22	61
Forcible Rape	--	2	11	4	7	9	33
Robbery	4	21	93	85	95	90	388
Aggravated Assault	36	172	391	228	329	303	1,459
Burglary	85	300	692	559	479	505	2,620
Larceny-Theft	226	1,174	2,536	1,376	1,310	1,190	7,812
Motor Vehicle Theft	3	68	304	299	345	289	1,308
Arson	57	76	82	18	22	7	262
PART I SUBTOTAL	411	1,813	4,116	2,580	2,608	2,415	13,943
PART II							
Manslaughter by Negligence	--	--	1	--	--	1	2
Other Assaults - Simple	96	468	965	588	631	621	3,369
Forgery and Counterfeiting	--	5	8	22	28	37	100
Fraud	--	2	6	5	18	27	58
Embezzlement	--	1	--	5	5	5	16
Stolen Property	3	22	158	133	156	158	630
Vandalism	184	538	970	612	646	512	3,462
Weapons: Carrying, Possessing	2	41	197	148	247	268	903
Prostitution and Comm. Vice	--	--	1	2	1	3	7
Sex Offenses	27	37	109	50	31	36	290
DRUGS, SALE OR MFG.							
Opium, Cocaine, Derivatives	--	--	16	23	26	36	101
Marijuana	--	8	59	46	35	58	206
Synthetic Narcotics	--	1	6	4	6	9	26
Other Dangerous Nonnarcotics	2	2	15	11	26	18	74
DRUGS, POSSESSION							
Opium, Cocaine, Derivatives	--	1	10	17	26	48	102
Marijuana	4	91	409	393	522	602	2,021
Synthetic Narcotics	--	2	24	12	32	63	133
Other Dangerous Nonnarcotics	--	24	116	94	139	138	511
All Gambling	--	1	1	1	1	3	7
Offenses Against Family/Children	--	--	--	--	--	--	--
Driving Under the Influence	2	2	4	9	55	169	241
Liquor Laws	4	33	273	479	1,012	1,528	3,329
Disorderly Conduct	57	260	819	593	627	579	2,935
Vagrancy	--	1	12	9	11	8	41
All Other, Except Traffic	102	383	1,084	820	966	886	4,241
Curfew/Loitering	23	260	1,371	1,222	1,470	1,443	5,789
Runaways	45	313	1,073	740	807	499	3,477
PART II SUBTOTAL	551	2,496	7,707	6,038	7,524	7,755	32,071
TOTAL	962	4,309	11,823	8,618	10,132	10,170	46,014

JUVENILE FEMALE ARRESTS

OFFENSE CLASSIFICATION	AGE						TOTAL JUVENILE
	UNDER 10	10-12	13-14	15	16	17	
PART I							
Murder/Nonneg. Manslaughter	--	--	1	3	2	2	8
Forcible Rape	--	--	1	--	--	--	1
Robbery	--	1	11	10	13	12	47
Aggravated Assault	3	27	96	49	59	41	275
Burglary	7	39	92	66	46	29	279
Larceny-Theft	58	482	1,226	679	588	509	3,542
Motor Vehicle Theft	--	18	110	76	60	36	300
Arson	7	9	19	3	--	2	40
PART I SUBTOTAL	75	576	1,556	886	768	631	4,492
PART II							
Manslaughter by Negligence	--	--	--	1	--	--	1
Other Assaults - Simple	15	152	459	326	249	215	1,416
Forgery and Counterfeiting	--	2	7	3	20	15	47
Fraud	--	--	3	8	13	10	34
Embezzlement	1	--	1	1	1	3	7
Stolen Property	--	4	39	25	21	23	112
Vandalism	8	75	200	95	83	49	510
Weapons: Carrying, Possessing	--	1	15	12	9	12	49
Prostitution and Comm. Vice	--	1	2	3	3	4	13
Sex Offenses	--	1	7	3	4	2	17
DRUGS, SALE OR MFG							
Opium, Cocaine, Derivatives	--	--	5	3	8	10	26
Manjuana	--	4	14	13	9	7	47
Synthetic Narcotics	--	1	5	4	1	3	14
Other Dangerous Nonnarcotics	1	2	10	8	11	11	43
DRUGS, POSSESSION							
Opium, Cocaine, Derivatives	--	1	2	2	9	10	24
Manjuana	1	32	137	98	86	88	442
Synthetic Narcotics	--	1	7	7	13	12	40
Other Dangerous Nonnarcotics	--	10	45	29	19	17	120
All Gambling	--	--	1	1	--	--	2
Offenses Against Family/Children	--	--	--	--	--	--	--
Driving Under the Influence	--	--	--	2	12	27	41
Liquor Laws	--	13	190	215	305	393	1,116
Disorderly Conduct	7	88	374	227	185	149	1,030
Vagrancy	--	--	2	3	6	6	17
All Other, Except Traffic	16	95	418	290	233	211	1,263
Curfew/Loitering	4	116	900	757	704	552	3,033
Runaways	9	300	1,850	1,167	933	418	4,677
PART II SUBTOTAL	62	899	4,693	3,303	2,937	2,247	14,141
TOTAL	137	1,475	6,249	4,189	3,705	2,878	18,633

54 ADULT MALE ARRESTS

OFFENSE CLASSIFICATION	AGE																TOTAL ADULTS
	18	19	20	21	22	23	24	25-29	30-34	35-39	40-44	45-49	50-54	55-59	60-64	65-Over	
PART I																	
Murder/Nonneg. Manslaughter	23	20	19	12	12	5	12	35	30	24	9	14	3	3	3	5	229
Forcible Rape	6	4	12	13	7	12	8	52	43	28	12	6	5	2	1	--	211
Robbery	100	66	58	55	57	61	56	178	175	110	53	9	9	2	1	--	990
Aggravated Assault	293	245	200	195	218	218	198	957	928	664	367	240	107	51	44	45	4,970
Burglary	379	306	181	165	144	143	128	559	518	355	220	72	26	15	8	6	3,225
Larceny-Theft	1,190	943	753	717	694	675	663	2,983	3,069	2,522	1,653	769	393	197	174	255	17,650
Motor Vehicle Theft	219	135	110	92	78	79	80	306	238	157	72	29	12	3	--	5	1,615
Arson	5	4	1	2	5	2	1	14	25	14	9	7	6	2	2	4	103
PART I SUBTOTAL	2,215	1,723	1,334	1,251	1,215	1,195	1,146	5,084	5,026	3,874	2,395	1,146	561	275	233	320	28,993
PART II																	
Manslaughter by Negligence	--	2	--	--	--	--	--	7	7	5	4	1	1	1	1	1	30
Other Assaults - Simple	540	600	636	713	751	883	935	4,084	4,133	2,851	1,686	810	372	210	105	109	19,418
Forgery and Counterfeiting	48	68	72	60	57	69	44	237	227	130	75	40	12	3	4	1	1,147
Fraud	58	55	36	41	39	58	38	211	244	172	111	49	40	14	16	11	1,193
Embezzlement	8	16	5	7	7	10	3	31	24	14	6	1	6	--	--	3	141
Stolen Property	188	146	137	117	102	122	112	451	359	215	112	49	22	9	1	2	2,144
Vandalism	409	289	243	231	241	225	213	999	959	633	362	159	89	52	19	30	5,153
Weapons - Carrying, Possessing	303	294	221	218	190	176	155	636	476	267	167	77	48	14	8	11	3,261
Prostitution and Comm. Vice	3	13	5	9	16	12	17	91	86	50	42	33	10	10	9	8	414
Sex Offenses	41	48	48	39	34	58	64	243	289	269	163	116	66	46	25	46	1,595
DRUGS, SALE OR MFG.																	
Opium, Cocaine, Derivatives	40	34	42	38	38	39	41	169	134	80	49	25	10	9	4	3	755
Marijuana	54	82	57	46	60	58	54	206	169	117	63	26	16	8	3	3	1,022
Synthetic Narcotics	12	22	20	23	30	13	12	93	96	63	25	21	5	7	2	4	448
Other Dangerous Nonnarcotics	37	53	37	45	62	54	68	270	298	153	67	28	7	1	--	1	1,181
DRUGS, POSSESSION																	
Opium, Cocaine, Derivatives	51	63	62	44	63	63	43	303	265	227	113	59	17	8	2	--	1,383
Marijuana	637	628	507	402	337	365	333	1,278	1,007	647	351	138	49	15	12	9	6,715
Synthetic Narcotics	55	67	55	75	61	59	74	267	272	156	79	37	13	4	3	2	1,279
Other Dangerous Nonnarcotics	133	91	81	65	72	61	75	340	287	222	114	45	9	5	--	8	1,608
All Gambling	1	1	2	--	1	--	3	--	4	--	--	1	1	1	--	--	15
Offenses Against Family/Children	41	44	37	35	46	33	53	255	304	236	147	68	31	22	13	11	1,376
Driving Under the Influence	351	447	625	903	916	980	980	4,416	3,980	3,249	2,287	1,473	899	504	327	307	22,644
Liquor Laws	2,120	2,273	1,839	476	324	333	275	1,225	1,392	1,437	1,329	797	519	363	224	201	15,127
Disorderly Conduct	742	637	537	764	653	688	640	2,555	2,524	1,896	1,378	711	363	220	138	177	14,623
Vagrancy	29	32	14	25	17	15	25	97	118	93	115	41	18	18	7	7	671
All Other, Except Traffic	1,562	1,683	1,598	1,733	1,624	1,570	1,649	7,007	6,587	4,759	3,043	1,576	773	484	278	283	36,209
PART II SUBTOTAL	7,463	7,688	6,916	6,109	5,741	5,944	5,906	25,471	24,241	17,941	11,888	6,381	3,396	2,028	1,201	1,238	139,552
TOTAL	9,678	9,411	8,250	7,360	6,956	7,139	7,052	30,555	29,267	21,815	14,283	7,527	3,957	2,303	1,434	1,558	168,545

ADULT FEMALE ARRESTS

OFFENSE CLASSIFICATION	AGE																TOTAL ADULTS
	18	19	20	21	22	23	24	25-29	30-34	35-39	40-44	45-49	50-54	55-59	60-64	65-Over	
PART I																	
Murder/Nonneg. Manslaughter	3	--	1	--	1	2	2	5	6	7	3	--	1	--	--	--	31
Forcible Rape	--	--	--	--	--	--	--	--	--	--	1	--	--	--	--	--	1
Robbery	4	2	7	2	8	2	7	30	12	9	6	4	1	--	--	--	94
Aggravated Assault	32	22	33	32	41	35	32	148	171	109	64	34	27	13	1	10	804
Burglary	14	21	18	15	21	20	15	87	77	46	19	8	3	2	--	1	367
Larceny-Theft	460	370	326	289	298	284	235	1,302	1,331	983	576	326	168	99	82	148	7,277
Motor Vehicle Theft	18	12	11	8	12	7	10	46	41	17	8	2	3	--	--	--	195
Arson	1	--	1	--	--	--	--	4	8	6	1	1	--	3	--	--	25
PART I SUBTOTAL	532	427	397	346	381	350	301	1,622	1,646	1,177	678	375	203	117	83	159	8,794
PART II																	
Manslaughter by Negligence	1	--	--	--	--	--	--	--	2	--	1	--	--	--	--	--	4
Other Assaults - Simple	133	158	152	145	172	155	156	829	847	607	309	164	70	33	24	20	3,974
Forgery and Counterfeiting	19	31	17	19	22	27	29	125	131	67	30	11	7	1	--	1	537
Fraud	13	34	24	27	24	17	24	135	115	80	35	19	10	9	3	3	572
Embezzlement	1	2	3	3	1	5	1	14	9	7	4	5	--	--	1	1	57
Stolen Property	17	17	19	19	15	21	27	79	69	35	11	10	2	--	--	1	342
Vandalism	49	48	38	40	36	41	39	260	203	162	92	45	16	6	2	6	1,083
Weapons - Carrying, Possessing	19	24	13	11	11	13	19	53	57	31	25	8	5	1	--	1	291
Prostitution and Comm. Vice	21	39	40	51	60	46	85	329	298	217	107	21	5	2	--	--	1,321
Sex Offenses	1	3	8	3	4	4	4	40	45	24	19	1	1	--	--	--	157
DRUGS, SALE OR MFG.																	
Opium, Cocaine, Derivatives	4	8	5	4	9	9	4	28	31	29	8	6	3	--	--	--	148
Marijuana	9	10	1	12	5	8	11	38	30	25	12	11	6	--	2	1	181
Synthetic Narcotics	6	1	2	4	6	5	9	31	38	14	15	6	3	--	1	--	141
Other Dangerous Nonnarcotics	8	10	17	11	13	27	19	92	93	64	17	4	2	--	--	--	377
DRUGS, POSSESSION																	
Opium, Cocaine, Derivatives	7	4	12	10	15	13	12	84	70	59	37	5	5	--	--	--	333
Marijuana	95	96	71	68	53	63	59	222	218	132	64	23	9	1	1	3	1,178
Synthetic Narcotics	8	8	7	13	14	18	19	84	93	62	26	7	1	--	--	--	360
Other Dangerous Nonnarcotics	30	20	15	13	18	19	25	116	104	86	39	16	2	1	--	--	504
All Gambling	--	--	--	--	--	--	--	--	--	--	1	--	1	--	--	--	2
Offenses Against Family/Children	15	11	19	26	23	24	33	150	164	123	48	18	7	5	--	2	668
Driving Under the Influence	42	69	77	113	125	157	128	671	712	622	432	266	141	73	31	40	3,699
Liquor Laws	530	517	377	68	58	58	35	145	181	224	136	80	40	30	9	4	2,492
Disorderly Conduct	150	151	168	174	161	155	146	681	746	542	348	156	90	41	25	16	3,750
Vagrancy	10	7	6	2	3	3	3	14	19	11	5	5	4	--	2	1	95
All Other, Except Traffic	296	313	324	314	309	359	355	1,607	1,646	1,140	584	230	131	61	27	38	7,734
PART II SUBTOTAL	1,484	1,581	1,415	1,150	1,157	1,247	1,242	5,827	5,921	4,363	2,405	1,117	561	264	128	138	30,000
TOTAL	2,016	2,008	1,812	1,496	1,538	1,597	1,543	7,449	7,567	5,540	3,083	1,492	764	381	211	297	38,794

59 TOTAL ARRESTS BY COUNTY*

OFFENSE CLASSIFICATION	APACHE	COCHISE	COCONINO	GILA	GRAHAM	GREENLEE	LA PAZ	MARICOPA	MOHAVE	NAVAJO	PIMA	PINAL	SANTA CRUZ	YAVAPAI	YUMA
PART I															
Murder/Nonneg. Manslaughter	--	6	15	1	--	--	3	161	26	3	74	17	--	20	3
Forcible Rape	2	--	15	2	--	--	--	138	6	4	52	11	--	16	--
Robbery	4	13	22	6	2	--	2	1,038	34	15	304	28	36	15	--
Aggravated Assault	31	112	257	198	94	5	37	4,376	271	183	1,265	209	122	299	49
Burglary	39	108	304	87	53	7	25	3,573	285	111	1,219	234	105	290	51
Larceny-Theft	136	535	1,380	407	195	7	34	22,506	1,182	527	6,464	1,047	375	1,172	314
Motor Vehicle Theft	28	42	42	28	13	--	1	2,022	68	29	924	78	42	84	17
Arson	4	11	22	3	--	--	--	143	52	7	130	16	2	38	2
PART I SUBTOTAL	244	827	2,057	732	357	19	102	33,957	1,924	879	10,432	1,640	682	1,934	436
PART II															
Manslaughter by Negligence	--	1	--	--	--	--	--	22	4	--	7	2	--	--	1
Other Assaults - Simple	109	287	735	227	28	22	44	16,080	964	588	6,765	1,237	152	820	119
Forgery and Counterfeiting	--	3	35	14	26	1	--	1,428	60	7	170	25	2	55	5
Fraud	1	62	36	17	6	--	--	1,196	79	8	286	26	2	136	2
Embezzlement	--	7	2	1	--	--	1	198	2	--	8	1	--	1	--
Stolen Property	2	27	16	5	--	--	4	2,799	50	17	201	46	22	38	1
Vandalism	34	129	387	154	62	3	17	5,459	364	103	2,656	388	8	381	63
Weapons - Carrying, Possessing	1	27	93	25	10	--	5	3,162	143	30	734	110	38	106	20
Prostitution and Comm. Vice	--	--	--	--	1	--	--	1,430	--	--	323	--	--	1	--
Sex Offenses	6	11	119	30	12	2	2	1,277	85	24	386	41	1	54	9
DRUGS, SALE OR MFG.															
Opium, Cocaine, Derivatives	--	--	4	4	2	--	--	729	46	12	153	5	1	74	--
Marijuana	3	58	20	6	9	1	1	660	56	25	366	44	6	189	12
Synthetic Narcotics	3	1	4	1	6	--	5	191	36	14	219	18	--	131	--
Other Dangerous Nonnarcotics	--	6	8	2	1	--	--	1,428	89	5	51	4	--	79	2
DRUGS, POSSESSION															
Opium, Cocaine, Derivatives	--	5	62	10	3	1	7	1,449	12	13	136	74	13	49	8
Marijuana	85	215	355	66	53	12	11	5,774	305	74	2,709	111	119	380	87
Synthetic Narcotics	14	5	21	13	5	5	3	877	105	4	646	46	4	57	7
Other Dangerous Nonnarcotics	2	29	70	2	2	2	--	906	106	15	1,533	23	3	42	8
All Gambling	--	--	1	--	--	--	--	4	1	--	19	--	1	--	--
Offenses Against Family/Children	18	326	230	171	15	--	71	243	472	51	217	42	1	173	14
Driving Under the Influence	35	390	1,366	348	135	10	61	17,206	736	394	4,286	393	155	939	171
Liquor Laws	49	164	718	269	190	56	28	10,793	1,130	398	7,221	483	--	436	129
Disorderly Conduct	149	383	1,807	490	254	56	77	8,129	1,211	604	7,235	896	88	799	160
Vagrancy	--	7	110	11	6	1	--	368	15	208	83	4	--	8	3
All Other, Except Traffic	219	910	2,908	1,015	331	41	243	26,188	2,661	1,121	7,927	2,480	401	2,744	258
Curfew/Loitering (Juveniles)	10	171	29	5	43	6	--	6,751	86	22	1,516	102	--	76	5
Runaways (Juveniles)	35	369	106	65	13	3	4	2,975	262	136	3,586	218	5	314	63
PART II SUBTOTAL	775	3,593	9,242	2,951	1,213	222	584	117,722	9,080	3,873	49,439	6,819	1,022	8,082	1,147
TOTAL	1,019	4,420	11,299	3,683	1,570	241	686	151,679	11,004	4,752	59,871	8,459	1,704	10,016	1,583

*Refer to page 13 for those agencies that provided only partial data or no data in 1994.

ADULT ARRESTS BY COUNTY*

OFFENSE CLASSIFICATION	APACHE	COCHISE	COCONINO	GILA	GRAHAM	GREENLEE	LA PAZ	MARICOPA	MOHAVE	NAVAJO	PIMA	PINAL	SANTA CRUZ	YAVAPAI	YUMA
PART I															
Murder/Nonneg. Manslaughter	--	6	11	1	--	--	2	125	24	3	56	9	--	20	3
Forcible Rape	1	--	11	--	--	--	--	121	6	2	49	11	--	11	--
Robbery	4	8	16	4	2	--	2	743	23	13	224	19	14	12	--
Aggravated Assault	26	77	192	135	59	4	36	3,426	211	149	928	144	86	258	43
Burglary	13	41	93	37	23	1	12	2,180	143	58	652	103	50	153	33
Larceny-Theft	51	255	1,012	184	105	4	28	16,271	854	261	3,993	631	265	743	270
Motor Vehicle Theft	8	18	20	15	2	--	1	1,145	34	7	443	34	28	44	11
Arson	3	3	13	2	--	--	--	38	18	3	29	6	2	10	1
PART I SUBTOTAL	106	408	1,368	378	191	9	81	24,049	1,313	496	6,374	957	445	1,251	361
PART II															
Manslaughter by Negligence	--	1	--	--	--	--	--	21	4	--	6	2	--	--	--
Other Assaults - Simple	70	155	647	165	20	14	37	13,856	782	459	5,370	959	111	657	90
Forgery and Counterfeiting	--	2	33	13	21	1	--	1,340	49	3	140	22	2	54	4
Fraud	1	61	34	17	5	--	--	1,131	77	8	273	23	2	131	2
Embezzlement	--	6	1	1	--	--	1	178	2	--	8	--	--	1	--
Stolen Property	2	16	10	4	--	--	4	2,166	39	11	163	30	16	24	1
Vandalism	6	49	276	67	24	--	9	3,453	192	62	1,661	189	4	222	22
Weapons - Carrying, Possessing	1	23	68	15	6	--	5	2,575	119	17	531	68	27	82	15
Prostitution and Comm. Vice	--	--	--	--	1	--	--	1,413	--	--	320	--	--	1	--
Sex Offenses	3	7	112	23	9	2	2	1,110	73	18	309	32	1	47	4
DRUGS, SALE OR MFG.															
Opium, Cocaine, Derivatives	--	--	4	1	2	--	--	657	41	11	139	5	--	43	--
Marijuana	2	48	16	6	6	1	1	522	51	21	317	20	3	179	10
Synthetic Narcotics	3	--	--	--	3	--	5	181	36	14	211	15	--	121	--
Other Dangerous Nonnarcotics	--	5	8	2	1	--	--	1,322	86	5	44	4	--	79	2
DRUGS, POSSESSION															
Opium, Cocaine, Derivatives	--	5	56	9	3	1	5	1,378	11	12	119	55	13	41	8
Marijuana	65	167	291	48	33	8	11	4,475	249	44	1,947	79	94	321	61
Synthetic Narcotics	12	1	10	7	4	5	3	810	91	4	596	40	4	45	7
Other Dangerous Nonnarcotics	2	26	58	2	--	2	--	715	99	11	1,128	22	1	39	7
Other Offenses															
All Gambling	--	--	--	--	--	--	--	4	1	--	12	--	--	--	--
Offenses Against Family/Children	18	326	230	171	15	--	71	243	472	51	217	42	1	173	14
Driving Under the Influence	34	390	1,348	344	134	10	60	17,028	725	386	4,242	392	153	929	168
Liquor Laws	27	105	532	158	110	15	20	8,568	841	183	6,347	350	--	264	99
Disorderly Conduct	121	292	1,666	394	178	43	71	7,000	1,027	461	5,590	668	68	674	120
Vagrancy	--	5	110	6	3	1	--	341	7	206	73	4	--	8	2
All Other, Except Traffic	166	696	2,513	861	181	34	237	23,964	2,273	968	6,765	2,202	345	2,502	236
Curfew/Loitering (Juveniles)	--	--	--	--	--	--	--	--	--	--	--	--	--	--	--
Runaways (Juveniles)	--	--	--	--	--	--	--	--	--	--	--	--	--	--	--
PART II SUBTOTAL	533	2,386	8,023	2,314	759	137	542	94,451	7,347	2,955	36,528	5,223	845	6,637	872
TOTAL	639	2,794	9,391	2,692	950	146	623	118,500	8,660	3,451	42,902	6,180	1,290	7,888	1,233

*Refer to page 13 for those agencies that provided only partial data or no data in 1994.

JUVENILE ARRESTS BY COUNTY*

OFFENSE CLASSIFICATION	APACHE	COCHISE	COCONINO	GILA	GRAHAM	GREENLEE	LA PAZ	MARICOPA	MOHAVE	NAVAJO	PIMA	PINAL	SANTA CRUZ	YAVAPAI	YUMA
PART I															
Murder/Nonneg. Manslaughter	--	--	4	--	--	--	1	36	2	--	18	8	--	--	--
Forcible Rape	1	--	4	2	--	--	--	17	--	2	3	--	--	5	--
Robbery	--	5	6	2	--	--	--	295	11	2	80	9	22	3	--
Aggravated Assault	5	35	65	63	35	1	1	950	60	34	337	65	36	41	6
Burglary	26	67	211	50	30	6	13	1,393	142	53	567	131	55	137	18
Larceny-Theft	85	280	368	223	90	3	6	6,235	328	266	2,471	416	110	429	44
Motor Vehicle Theft	20	24	22	13	11	--	--	877	34	22	481	44	14	40	6
Arson	1	8	9	1	--	--	--	105	34	4	101	10	--	28	1
PART I SUBTOTAL	138	419	689	354	166	10	21	9,908	611	383	4,058	683	237	683	75
PART II															
Manslaughter by Negligence	--	--	--	--	--	--	--	1	--	--	1	--	--	--	1
Other Assaults - Simple	39	132	88	62	8	8	7	2,224	182	129	1,395	278	41	163	29
Forgery and Counterfeiting	--	1	2	1	5	--	--	88	11	4	30	3	--	1	1
Fraud	--	1	2	--	1	--	--	65	2	--	13	3	--	5	--
Embezzlement	--	1	1	--	--	--	--	20	--	--	--	1	--	--	--
Stolen Property	--	11	6	1	--	--	--	633	11	6	38	16	6	14	--
Vandalism	28	80	111	87	38	3	8	2,006	172	41	995	199	4	159	41
Weapons - Carrying, Possessing	--	4	25	10	4	--	--	587	24	13	203	42	11	24	5
Prostitution and Comm. Vice	--	--	--	--	--	--	--	17	--	--	3	--	--	--	--
Sex Offenses	3	4	7	7	3	--	--	167	12	6	77	9	--	7	5
DRUGS, SALE OR MFG.															
Opium, Cocaine, Derivatives	--	--	--	3	--	--	--	72	5	1	14	--	1	31	--
Marijuana	1	10	4	--	3	--	--	138	5	4	49	24	3	10	2
Synthetic Narcotics	--	1	4	1	3	--	--	10	--	--	8	3	--	10	--
Other Dangerous Nonnarcotics	--	1	--	--	--	--	--	106	3	--	7	--	--	--	--
DRUGS, POSSESSION															
Opium, Cocaine, Derivatives	--	--	6	1	--	--	2	71	1	1	17	19	--	8	--
Marijuana	20	48	64	18	20	4	--	1,299	56	30	762	32	25	59	26
Synthetic Narcotics	2	4	11	6	1	--	--	67	14	--	50	6	--	12	--
Other Dangerous Nonnarcotics	--	3	12	--	2	--	--	191	7	4	405	1	2	3	1
All Gambling	--	--	1	--	--	--	--	--	--	--	7	--	1	--	--
Offenses Against Family/Children	--	--	--	--	--	--	--	--	--	--	--	--	--	--	--
Driving Under the Influence	1	--	18	4	1	--	1	178	11	8	44	1	2	10	3
Liquor Laws	22	59	186	111	80	41	8	2,225	289	215	874	133	--	172	30
Disorderly Conduct	28	91	141	96	76	13	6	1,129	184	143	1,645	228	20	125	40
Vagrancy	--	2	--	5	3	--	--	27	8	2	10	--	--	--	1
All Other, Except Traffic	53	214	395	154	150	7	6	2,224	388	153	1,162	278	56	242	22
Curfew/Loitering (Juveniles)	10	171	29	5	43	6	--	6,751	86	22	1,516	102	--	76	5
Runaways (Juveniles)	35	369	106	65	13	3	4	2,975	262	136	3,586	218	5	314	63
PART II SUBTOTAL	242	1,207	1,219	637	454	85	42	23,271	1,733	918	12,911	1,596	177	1,445	275
TOTAL	380	1,626	1,908	991	620	95	63	33,179	2,344	1,301	16,969	2,279	414	2,128	350

*Refer to page 13 for those agencies that provided only partial data or no data in 1994.

POLICE DISPOSITION OF JUVENILES

COUNTY	TOTAL	Handled within Department and Released	Referred to Juvenile Court or Prob. Dept.	Referred to Welfare Agency	Referred to Other Police Agency	Referred to Criminal or Adult Court
APACHE	384	25	354	4	--	1
COCHISE	1,632	172	1,453	--	2	5
COCONINO	1,908	53	1,842	--	6	7
GILA	1,007	83	908	--	16	--
GRAHAM	620	30	585	--	5	--
GREENLEE	95	--	95	--	--	--
LA PAZ	63	2	60	--	--	1
MARICOPA	33,558	2,543	26,796	1,229	382	2,608
MOHAVE	2,344	28	2,316	--	--	--
NAVAJO	1,306	49	1,253	--	2	2
PIMA	16,989	1,469	14,631	1	16	872
PINAL	2,281	344	1,918	6	10	3
SANTA CRUZ	415	15	396	--	4	--
YAVAPAI	2,489	491	1,986	3	9	--
YUMA	360	97	262	--	1	--
STATE TOTAL	65,451	5,401	54,855	1,243	453	3,499

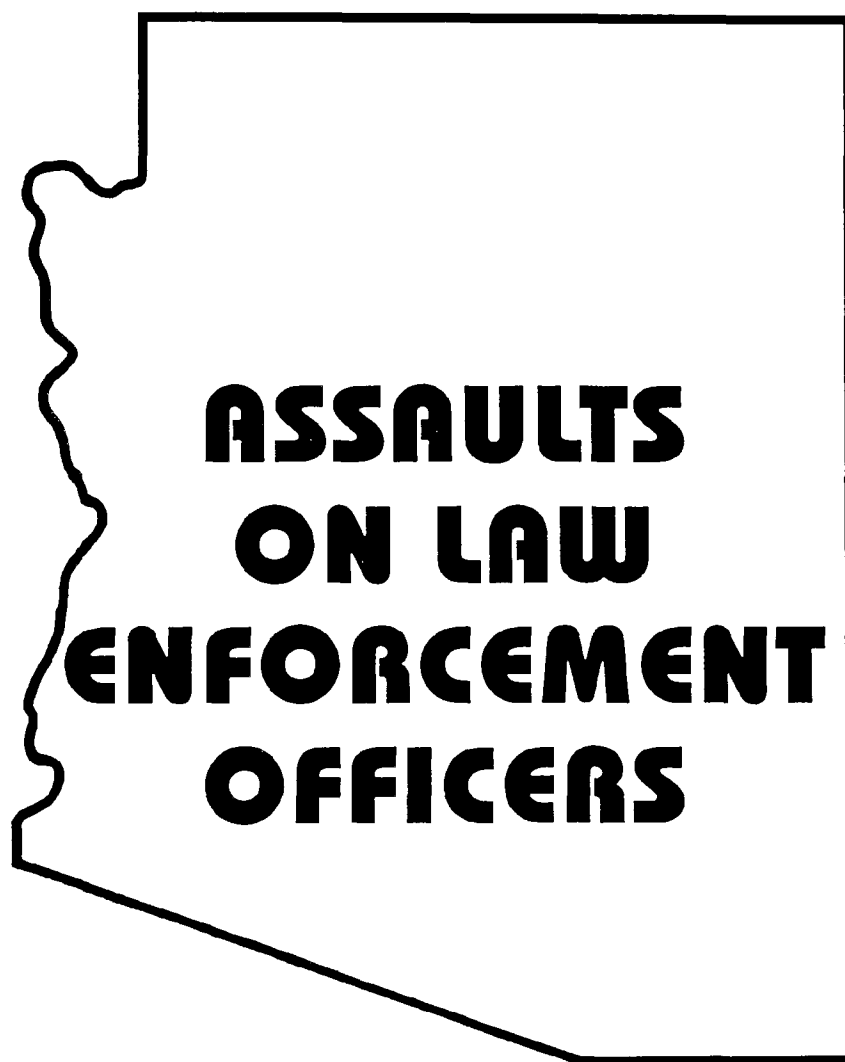

**ASSAULTS
ON LAW
ENFORCEMENT
OFFICERS**

POLICE OFFICER ASSAULTS

DEFINITION

All assaults on sworn officers resulting in serious injury or in which a weapon was used that could have caused serious injury or death. Also included are assaults not causing injury which involved more than mere verbal abuse or minor resistance to arrest.

SUMMARY

- There were a total of 1,583 police officers assaulted statewide in 1994.
- Personal weapons, such as hands, fists, and feet, were used in 1,233 assaults, or 77.9 percent.
- The time period of 10:01 PM to midnight recorded the highest number of assaults with 337, or 21.3 percent.
- The highest number of assaults, 685, or 43.3 percent, occurred when officers were responding to disturbance calls.
- Personal injuries were sustained in 341 assaults, or 21.5 percent.

CLEARANCES

- There were a total of 1,518 clearances for assaults on police officers. This represents a clearance rate of 95.9 percent.

INJURY VS. NONINJURY

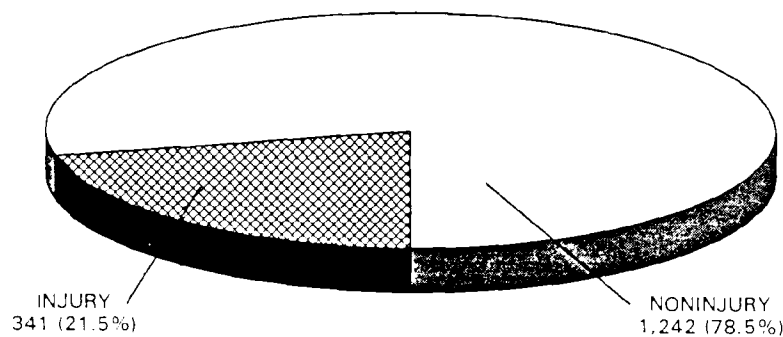

WEAPONS USED

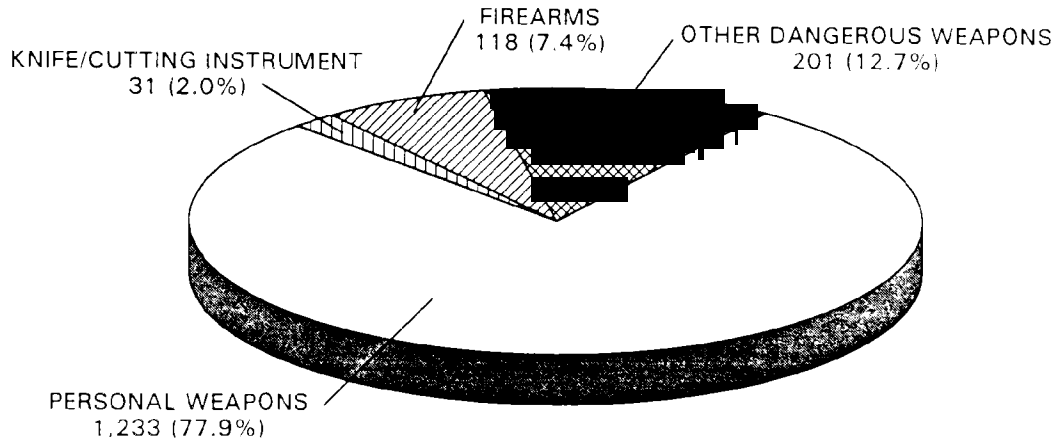

TIME OF DAY

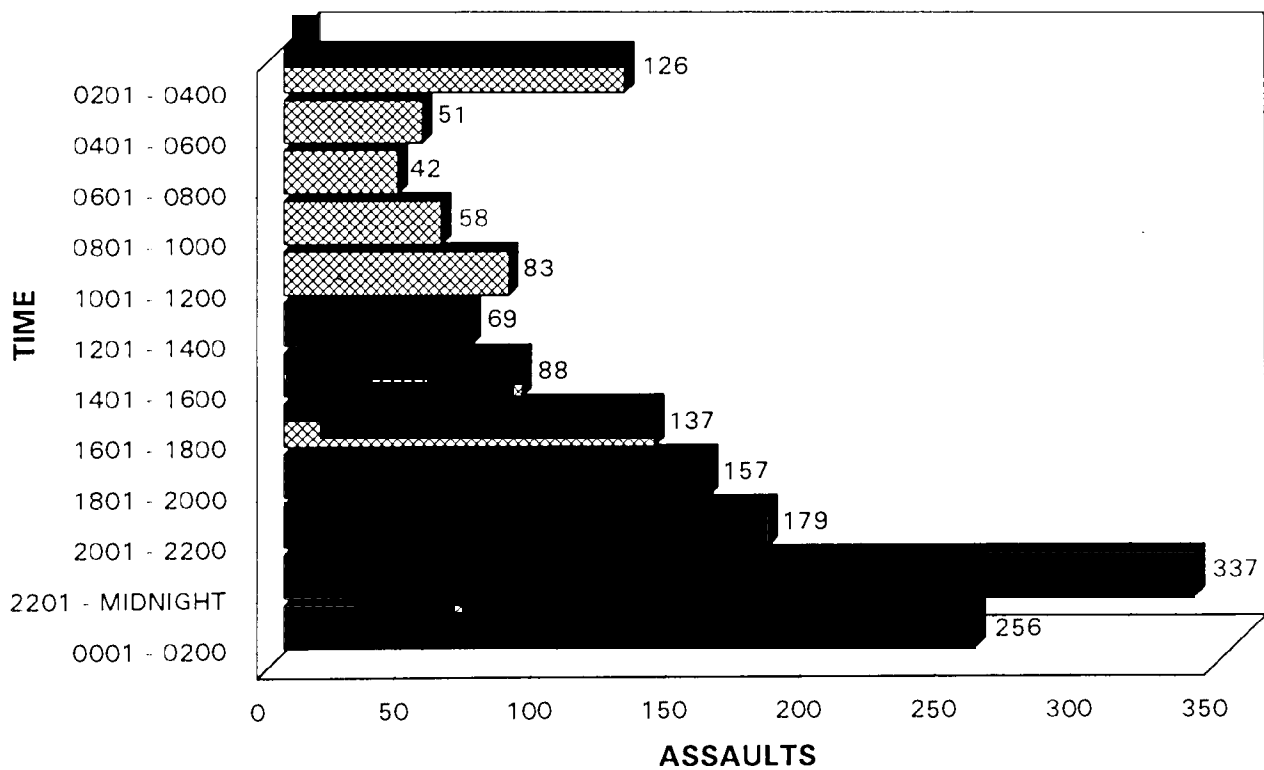

OFFICERS ASSAULTED DISTRIBUTION BY COUNTY

COUNTY	NUMBER OF ASSAULTS	WITH INJURY	WITHOUT INJURY	PERCENT DISTRIBUTION	CLEARANCE
Apache	2	--	2	0.1%	2
Cochise	15	6	9	1.0%	14
Coconino	13	7	6	0.8%	13
Gila	12	3	9	0.8%	12
Graham	2	2	--	0.1%	2
Greenlee	--	--	--	0.0%	--
La Paz	9	3	6	0.6%	9
Maricopa	1,053	209	844	66.5%	1,011
Mohave	26	3	23	1.6%	26
Navajo	26	13	13	1.6%	26
Pima	374	75	299	23.6%	354
Pinal	22	11	11	1.4%	22
Santa Cruz	4	3	1	0.3%	2
Yavapai	23	5	18	1.5%	23
Yuma	2	1	1	0.1%	2
TOTAL	1,583	341	1,242	100.0%	1,518



**BIAS
CRIMES
DATA**

BIAS (HATE) CRIME DATA COLLECTION

BACKGROUND

The collection of bias (hate) crime statistics is the latest addition to the Uniform Crime Reporting program. It reflects a growing concern on both a federal and state level to the problem of crimes being committed due to bias or hate.

The collection of these statistics began with the passage of Public Law 101-275, known as the Hate Crime Statistics Act, in April 1990. The Act required the Attorney General to establish guidelines and collect data "about crimes that manifest evidence of prejudice based on race, religion, sexual orientation, or ethnicity, including where appropriate the crimes of murder, non-negligent manslaughter, forcible rape, aggravated assault, simple assault, intimidation, arson, and destruction, damage or vandalism of property."

In Arizona, legislation mandating the collection of bias (hate) crime statistics was passed in 1991. Arizona Revised Statutes 41-1750 was amended in part to read that the criminal identification section within the Department of Public Safety shall "Collect information concerning criminal offenses that manifest evidence of prejudice based on race, color, religion, national origin, sexual orientation, gender or disability."

Statewide collection began January 1992. Statistics received from Arizona law enforcement agencies for 1994 are listed on the following pages.

LOCATION OF BIAS OFFENSES

	NUMBER OF OFFENSES	PERCENT OF TOTAL
Construction Area	1	0.5%
Highway/Road/Alley	32	14.9%
Residence/Home	73	33.9%
Parking Lot/Garage	25	11.6%
Lake Area	1	0.5%
Restaurant	5	2.3%
School/College	10	4.7%
Commercial/Office Building	9	4.2%
Grocery/Supermarket	3	1.4%
Bar/Nightclub	8	3.7%
Government/Public Building	2	0.9%
Hotel/Motel	3	1.4%
Service/Gas Station	9	4.2%
Church/Synagogue	20	9.3%
Speciality Store	2	0.9%
Other/Unknown	12	5.6%
TOTAL	215	100.0%

BIAS MOTIVATION

	NUMBER OF OFFENSES	PERCENT OF TOTAL
RACE	111	51.6%
Anti-White	24	11.1%
Anti-Black	75	34.9%
Anti-American Indian	1	0.5%
Anti-Asian/Pacific Islander	7	3.2%
Anti-Multi-Racial	4	1.9%
ETHNIC/NATIONAL ORIGIN	30	14.0%
Anti-Hispanic	23	10.7%
Anti-Arab	5	2.4%
Anti-Other Ethnicity	2	0.9%
RELIGION	43	20.0%
Anti-Jewish	29	13.5%
Anti-Catholic	3	1.4%
Anti-Protestant	2	0.9%
Anti-Other Religion	9	4.2%
SEXUAL ORIENTATION	31	14.4%
Anti-Male Homosexual	24	11.2%
Anti-Female Homosexual	3	1.4%
Anti-Homosexual	4	1.8%
TOTAL	215	100.0%



**FULL-TIME
LAW
ENFORCEMENT
EMPLOYEES**

FULL-TIME LAW ENFORCEMENT EMPLOYEES

DEFINITION

The following chart reflects full-time law enforcement personnel employed as of October 31, 1994. These figures include full-time sworn personnel with full arrest powers; however they do not include persons performing guard or protection duties, such as school crossing guards, nor reserve officers. Civilian employees include clerks, dispatchers, secretaries, etc. who are employed full-time and are paid from law enforcement funds or budget.

DISTRIBUTION OF EMPLOYEES

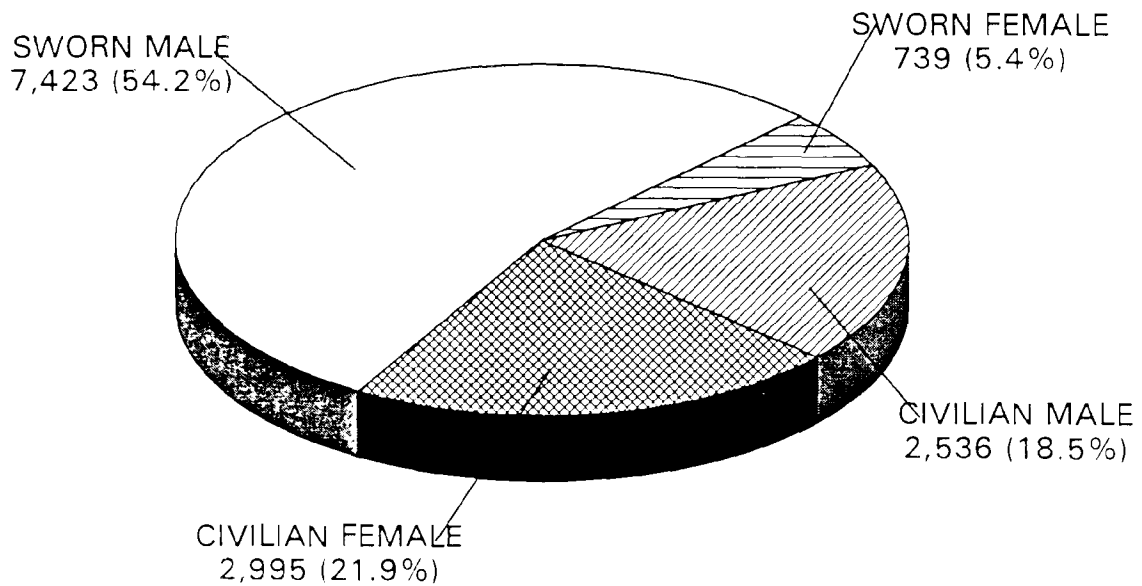

NUMBER OF EMPLOYEES BY AGENCY

AGENCY	SWORN		CIVILIAN		TOTAL	POPULATION
	MALE	FEMALE	MALE	FEMALE		
APACHE COUNTY SO	24	1	13	13	51	53,505
APACHE JUNCTION PD	41	2	3	13	59	19,175
AVONDALE PD	33	2	2	6	43	22,855
BENSON PD	10	--	2	4	16	4,035
BISBEE PD	11	1	1	5	18	6,500
BUCKEYE PD	14	2	7	1	24	5,065
BULLHEAD CITY PD	52	4	4	30	90	26,535
CAMP VERDE MO	13	--	4	6	23	7,210
CASA GRANDE PD	43	4	3	16	66	20,355
CHANDLER PD	152	5	7	50	214	115,095
CHINO VALLEY PD	10	1	--	6	17	5,645
CLARKDALE PD	8	--	--	--	8	2,460
CLIFTON PD	6	--	1	5	12	2,980
COCHISE COUNTY SO	61	1	68	28	158	39,855
COCONINO COUNTY SO	51	9	35	28	123	45,765
COOLIDGE PD	18	1	--	6	25	7,035
COTTONWOOD PD	15	1	6	7	29	6,300
DOUGLAS PD	32	1	4	8	45	14,495
DUNCAN PD	1	--	--	--	1	735
EAGAR PD	6	--	--	1	7	4,505
EL MIRAGE PD	10	--	--	5	15	5,245
ELOY PD	18	1	7	2	28	7,680
FLAGSTAFF PD	74	4	7	27	112	50,465
FLORENCE PD	11	2	1	5	19	8,825
FOUNTAIN HILLS MO	3	--	--	1	4	12,005
FREDONIA MO	2	--	--	1	3	1,245
GILA COUNTY SO	52	3	22	36	113	24,580
GILBERT PD	48	10	2	22	82	48,480
GLENDALE PD	204	22	29	53	308	164,890
GLOBE PD	17	3	2	6	28	6,320
GOODYEAR PD	17	2	--	6	25	8,315
GRAHAM COUNTY SO	13	2	9	5	29	16,690
GREENLEE COUNTY SO	14	--	8	1	23	4,710
HAYDEN PD	6	--	--	1	7	910
HOLBROOK PD	14	1	--	5	20	4,880
HUACHUCA CITY PD	5	--	2	3	10	1,915
JEROME PD	3	--	--	--	3	410
KEARNY PD	6	1	1	2	10	2,440
KINGMAN PD	32	5	1	16	54	15,430
LA PAZ COUNTY SO	30	1	16	18	65	11,160
LAKE HAVASU CITY PD	50	2	6	14	72	34,350
MAMMOTH PD	5	--	--	--	5	1,920
MARANA PD	27	4	--	7	38	3,570
MARICOPA COUNTY SO	425	27	768	489	1,709	199,180
MESA PD	454	48	66	178	746	318,885
MIAMI PD	5	--	1	2	8	2,035
MOHAVE COUNTY SO	80	7	75	52	214	41,025
NAVAJO COUNTY SO	38	2	16	20	76	51,430
NOGALES PD	57	1	6	12	76	20,300
ORO VALLEY PD	31	3	2	10	46	11,945
PAGE PD	15	2	--	8	25	7,345

NUMBER OF EMPLOYEES BY AGENCY (CONTINUED)

AGENCY	SWORN		CIVILIAN		TOTAL	POPULATION
	MALE	FEMALE	MALE	FEMALE		
PARADISE VALLEY PD	30	1	4	5	40	12,580
PARKER PD	11	--	--	2	13	2,920
PATAGONIA MO	4	--	--	--	4	940
PAYSON PD	18	2	8	2	30	9,505
PEORIA PD	63	8	4	23	98	65,500
PHOENIX PD	1,878	210	248	508	2,844	1,051,515
PIMA COUNTY SO	314	51	384	232	981	267,055
PIMA PD	2	--	--	--	2	1,875
PINAL COUNTY SO	106	12	61	49	228	61,310
PINETOP-LAKESIDE PD	12	1	2	4	19	2,565
PRESCOTT PD	43	6	7	19	75	29,155
PRESCOTT VALLEY PD	16	1	1	6	24	13,095
QUARTZSITE MO	6	--	--	1	7	1,995
SAFFORD PD	14	1	1	1	17	8,020
ST. JOHNS PD	6	--	--	1	7	3,350
SAN LUIS PD	13	2	1	5	21	7,910
SANTA CRUZ COUNTY SO	31	--	13	14	58	11,160
SCOTTSDALE PD	217	21	41	88	367	154,145
SEDONA PD	16	1	1	6	24	8,480
SHOW LOW PD	16	--	1	7	24	5,605
SIERRA VISTA PD	35	1	1	12	49	36,855
SNOWFLAKE-TAYLOR PD	12	--	1	2	15	6,525
SOMERTON PD	9	2	1	3	15	5,970
SOUTH TUCSON PD	13	2	3	4	22	5,520
SPRINGERVILLE PD	5	--	1	1	7	1,915
SUPERIOR PD	6	2	--	4	12	3,485
SURPRISE PD	18	1	--	2	21	9,470
TEMPE PD	240	23	35	80	378	150,615
THATCHER PD	7	--	--	--	7	4,040
TOLLESON PD	15	1	3	4	23	4,605
TOMBSTONE MO	4	1	--	1	6	1,300
TUCSON PD	664	108	54	193	1,019	440,335
WELLTON MO	3	--	--	--	3	1,075
WICKENBURG PD	10	--	4	1	15	4,785
WILLCOX PD	10	--	1	4	15	3,270
WILLIAMS PD	7	--	1	5	13	2,680
WINSLOW PD	19	2	--	9	30	10,745
YAVAPAI COUNTY SO	75	5	40	52	172	50,745
YOUNGTOWN PD	8	1	2	3	14	2,670
YUMA COUNTY SO	48	3	88	30	169	44,545
YUMA PD	96	10	7	37	150	60,150
Agencies with no measurable population						
AZ DEPT. OF PUBLIC SAFETY	787	53	273	281	1,394	N/A
AZ STATE CAPITOL PD	26	1	20	12	59	N/A
AZ STATE UNIV DPS	28	6	3	14	51	N/A
AZ STATE UNIV WEST DPS	8	--	6	2	16	N/A
AZ WESTERN COLLEGE PD	5	2	--	1	8	N/A
CENTRAL AZ COLLEGE PD	5	--	--	--	5	N/A
NORTHERN AZ UNIV PD	17	1	4	7	29	N/A
PIMA COLLEGE PD	20	3	1	6	30	N/A
UNIV. OF AZ PD	37	4	3	12	56	N/A
YAVAPAI COLLEGE PD	3	2	--	--	5	N/A

GLOSSARY

ADULT	For UCR, a person aged 18 or over.
AMERICAN INDIAN or ALASKAN NATIVE	A person having origins in any of the original peoples of North America, and who maintains cultural identification through tribal affiliation or community recognition.
ASIAN or PACIFIC ISLANDER	A person having origins in any of the original peoples of the Far East, Southeast Asia, the Indian subcontinent, or the Pacific Islands. This area includes for example: China, India, Japan, Korea, the Philippine Islands, and Samoa.
BLACK	A person having origins in any of the black racial groups of Africa, characterized by dark skin pigmentation.
CLEARED BY ARREST prosecution.	An offense that is cleared (solved) when at least one person is arrested, charged with the commission of the offense, and turned over to the court for
CRIMES AGAINST PERSONS	Includes the following Index offenses: Murder, rape and aggravated assault.
CRIME INDEX	Total of eight offenses used to measure the extent, fluctuation and distribution of crime in a given geographical area. The Crime Index includes: Murder, rape, robbery, aggravated assault, burglary, larceny-theft, motor vehicle theft and arson.
EXCEPTIONAL CLEARANCE	An offense that is cleared when an offender has been identified, located, and there is some reason beyond law enforcement control which prohibits bringing the offender to court.
HIERARCHY RULE	A UCR scoring practice used in multiple offense situations where only the most serious offense (as determined by the established crime index order) is counted.
HISPANIC	A person of Mexican, Cuban, Central or South American, or other Spanish culture or origin, regardless of race.
JUVENILE	For UCR, any person under the age of 18.
JUVENILE CLEARANCE	Offenses involving only persons under the age of 18 that are cleared by arrest or exceptional means.
NONVIOLENT CRIME	Any of the following Index offenses: Burglary, larceny-theft, motor vehicle theft and arson.
VIOLENT CRIME	Any of the following Index offenses: Murder, rape, robbery and aggravated assault.
WHITE	A person having origins in any of the original peoples of Europe, North Africa or the Middle East.